

**SOUTHERN REGION CONFERENCE**



**HELD IN CONJUNCTION WITH THE MEETING OF THE  
SOUTHERN ASSOCIATION OF AGRICULTURAL SCIENTISTS (SAAS)**



**February 3 – February 6, 2018 – Jacksonville, FL**

**Hosted by  
Middle Tennessee State University, Tennessee State University,  
Tennessee Technological University, University of Tennessee,  
University of Tennessee at Martin**

## 2018 Southern Region Reviewers

Antoine Alston  
James Anderson II  
Marshall Baker  
Kirby Barrick  
Kimberly Bellah  
Matthew Bengé  
Joey Blackburn  
Gary Briers  
Jackie Bruce  
JC Bunch  
Alex Byrd  
James Christiansen  
Steven Chumbley  
Chris Clemons  
Barry Croom  
Catherine DiBenedetto  
Kim Dooley  
Tiffany Drape  
James Dyer  
Don Edgar  
Leslie Edgar  
Kirk Edney  
Craig Edwards  
Rebecca Epps  
Chris Estep  
Paula Faulkner  
Frank Flanders  
Jim Flowers  
Curt Friedel  
Nick Fuhrman

Donna Graham  
Laura Greenhaw  
Amy Harder  
Jay Jayaratne  
Don Johnson  
Adam Kantrovich  
Eric Kaufman  
Barbara Kirby  
Alexa Lamm  
Doug LaVergne  
James Lindner  
OP McCubbins  
Gary Moore  
Joy Morgan  
Tim Murphy  
Brian Myers  
Michael Newman  
Summer Odom  
Ed Osborne  
Travis Park  
Brian Parr  
Jason Peake  
Bryan Rank  
John Rayfield  
Tobin Redwine  
John C. Ricketts  
Grady Roberts  
Shane Robinson  
Eric Rubenstein  
Donna Westfall-Rudd

Rick Rudd  
Joy Rumble  
Ryan Saucier  
Kate Shoulders  
Matt Spindler  
Kristin Stair  
Nicole Stedman  
Carrie Stephens  
Katie Stofer  
Chris Stripling  
Robert Strong  
Kirk Swortzel  
Lisa Taylor  
Rob Terry  
Andrew Thoron  
Stacy Vincent  
George Wardlow  
Laura Warner  
Wendy Warner  
Elizabeth Wilson  
Gary Wingenbach

---

**Saturday, February 3, 2018**

---

**3:00 – 6:00 p.m.**      **Registration, Third Floor Skybridge**

---

**Sunday, February 4, 2018**

---

**7:00 – 8:00 a.m.**      **Graduate Student Breakfast, Grand Ballroom Section 4**  
(Pre-registered graduate students)

**7:00 – 10:00 a.m.**      **Registration, Third Floor Skybridge**

**8:15 – 8:45 a.m.**      **Vespers, Grand Ballroom Section 3**

**9:00 – 9:30 a.m.**      **Agricultural Education Opening Session, Grand Ballroom Section 3**

---

**9:45 – 11:45 a.m.**      **Concurrent Research Session I – Teaching and Learning**  
*15-minute presentation each, 15 minutes of Discussion per presentation*

**Session A – Preservice Education, Grand Ballroom Section 2**

**Discussant and Chair:** Christopher Stripling

**Facilitator:** Kathryn Teixeira

**Reflecting on Experience: The Impact of Reflection Following FFA Civic Engagement Activities,** Will Bird, Amanda Bowling, and Anna Ball

**Deterrents to Service-Learning’s Use as a Method of Instruction in the Preparation of Agricultural Education Teachers: The Beliefs and Intentions of Teacher Educators,** Richie Roberts, M. Craig Edwards, and J. Shane Robinson

**Student Perceptions of Accelerated Course Delivery Format for Teacher Preparation Coursework,** Blake C. Colclasure, Sarah E. LaRose, Anna J. Warner, Taylor K. Ruth, J.C. Bunch, Andrew C. Thoron, and T. Grady Roberts

**Relationship Between Career and Technical Education Student Teachers’ Self-Efficacy and edTPA Performance,** Victoria P. Whitley, Travis D. Park, Wendy J. Warner, and Erin T. Horne

---

**Session B – School Based Education Programs, Grand Ballroom Section 3**

**Discussant and Chair:** Brian Myers

**Facilitator:** Cliff Ricketts

**Demographic Characteristics of Students in Secondary Agricultural Education Programs,** Sarah A Bush, Stephen Edwards, and Curtis R Friedel

**Teacher Perception of the Georgia Middle School Agricultural Education Curriculum**, David L. Chapman Jr. and James R. Lindner

**Impact of Teacher Attire on Students' Views of Teacher Credibility, Attitude Homophily, and Background Homophily within School-based Agricultural Education Programs**, Lesley Smith and Catherine W. Shoulders

**Job Satisfaction in Agricultural Education Teachers in North Carolina**, Robert Jason Davis, Jim Flowers, Wendy Warner, David Jones, and Gary E. Moore

---

**Session C – School Based Education Curriculum**, *Grand Ballroom Section 1*

**Discussant and Chair:** Barbara Kirby      **Facilitator:** Chris Eck

**A Multi-State Evaluation of Secondary Agricultural Education Students' Performance on Industry-Based Standards**, Preston Byrd, Stacy Vincent, Joan Mazur, and Kang Namkoong

**Comparative Analysis of Students Taught Science or Agriscience: Results on State Standardized Reading Assessment**, Anna J. Warner, Andrew C. Thoron, and Glenn D. Israel

**Effects of Novelty on Project-Based Methods when Integrating Physics into Agriculture Courses**, Jason McKibben and Tim Murphy

**The School in Biltmore Forest: The Beginning of Formal Forestry Education in America**, D. Barry Croom

---

**12:00 – 1:30 p.m.**      **Luncheon** (introduce new students and new faculty), *Grand Ballroom Section 4*

**1:30 – 2:30 p.m.**      **Committee Meetings**

**Membership Services**, *City Terrace 10*

**Program Improvement**, *City Terrace 9*

**Professional Development**, *City Terrace 8*

**Research**, *City Terrace 7*

**2:30 – 3:15 p.m.**      **SR-AAAE Business Meeting Session I**, *Grand Ballroom, Section 3*

**3:15 – 4:00 p.m.**      **SIG Meetings or Grantsmanship Roundtables**, *City Terrace 10, 9, 8, 7*

**4:15 – until**      **SAAS Reception/Super Bowl Party**, *Grand Ballroom Section 4 and 5*

---

**Monday, February 5, 2018**

---

**7:00 – 10:00 a.m.**      **Registration**, *Third Floor Skybridge*

**7:00 – 8:30 a.m. Innovative Poster Session (*with breakfast*), Conference Center A**

**#ChemicalAwareState: Farm Safety Goes Social**, Carla Jagger, Tobin Redwine, Sharon Wagner, Emily Berger, and Holli Leggette

**Auburn Agriscience Education Immersion Experience: An Exploratory Program for the Promotion and Improvement of Future Agriscience Teachers**, Chris Clemons

**I am Different, Not Less: Illustrating Strengths-Based Leadership Through the Lens of Temple Grandin**, Haley Rosson and Penny Pennington Weeks

**A Faculty Development Project: Creating a Community of Global Thinking Fellows**, Christopher T. Stripling, Nicole Stedman, James R. Lindner, Amy Harder, Robert Strong, T. Grady Roberts, Kim Dooley, and Lisa Lundy

**A Variable Frequency Drive Trainer for STEM Integration in Agricultural Mechanics**, Colton Teekell, Patterson Hilaire, and Donald Johnson

**An Intra-curricular Approach in Assisting Underserved Populations: Engaging the Community in Student Development**, Brooke N. Griggeory, Stacy K Vincent, Carol D. Hanley, and Dan W. Kahl

**Award Points Program: Utilization of Google Sheets™ Pivot Tables for Student Awards Points and Required FFA Activity Credits**, Kathryn Teixeira and Shane Robinson

**Creating Student Empowerment and Inclusion for Underserved Youth in Agriculture**, Elijah Parham and Stacy K. Vincent

**Critical Conversations: Using a Video Podcast to Engage Teachers in Philosophical Discussions about Agricultural Education**, Catherine W. Shoulders, Marshall A. Baker, and Brian E. Myers

**Developing a Learning Community of First Generation College Student Veterans**, Megan Stein, Summer Odom, Barry Boyd, Kelly Essler, Julie Harlin, and Lori Moore

**Early Field Observations: An In-depth Approach of Career Exploration Introduction**, Christopher Eck, Kathryn L Teixeira, and Robert Terry Jr.

**Educating First Responders to Assist in an Agricultural Hazardous Situation**, Sarah D. Warren, Stacy K. Vincent, Joan Mazur, and Dale Dobson

**Enabling Agriculture Teacher Candidate Preparation with Technology and Resources**, Victoria P. Whitley, Travis D. Park, Kevin W. Curry Jr., Wendy J. Warner, and Joy E. Morgan

**Filling Buckets for Our Beginning Ag Teachers**, Joy E. Morgan, Travis D. Park, and Wendy J. Warner

**Flip the Script! Implementing Team Based Learning in a Post-Secondary Agricultural Mechanics Course**, Whitney L. Figland and J. Joey Blackburn

**Grip and Grin: An Innovative Approach to Incorporating Advisory Committee Members into SAE Instruction**, Sarah E. LaRose, John D. Farrell, and Andrew C. Thoron

**In a SNAP: Nutrition Education in Food Desert Communities**, Eliza Green, Kendall M. Wright, Stacy K. Vincent, Jacqueline Corum, and Becca Self

**Integrating Experiential Learning into Ag Reporting and Feature Writing Coursework to Develop Metacognitive Skills and International Relations**, Kylie Ehlers, Isabel Whitehead, and Jefferson Miller

**Model Trailer Wiring Lesson**, Randy Lund, Jenna Gilbert, and Tim Murphy

**Optimizing Professional Networking through a Preparation Program for Students**, Samantha Blackwell and Shelly Sitton

**Plickers as a way for Test Review in Agricultural Education**, Brianna Shanholtzer, Andrew Thoron, and J.C. Bunch

**Poster Session in a Methods of Teaching Course: A Poster Poster**, Lee Thomsen, Sarah Warren, and Rebekah B. Epps

**Recruiting through Agricultural Education's Family Trees**, Travis D. Park, Joy E. Morgan, Mary Kate Morgan, and Wendy J. Warner

**Rounding Up Resources for Agricultural Teachers: Utilizing a Blog and Social Media to Disseminate Quality Resources**, Anna J. Warner, Catherine W. Shoulders, Marshall A. Baker, and Brian E. Myers

**Safety, Safety, Safety! Using the Lathe Safety Simulator to Introduce Proper Machinery Operation Principles and Work Habits**, Rachael Blackwell, Trent Wells, and OP McCubbins

**Swivl® and GoPro®: The Use of Video Recording Technologies to Enhance Student Learning**, Olivia Caillouet, Catherine Dobbins, Kathleen S. Jogan, and Leslie D. Edgar

**Using a Student Exchange Program to Foster New Agricultural Experiences for Students**, Blake Colclasure and Keith Schiebel

**Using Instagram Hashtags to Promote Agricultural Communications Students' Photography**, Kayla Jennings, Lindsay Kennedy, and Cindy Akers

**8:45 – 10:45 a.m.**     **Concurrent Research Session II - Extension and Professional Development**  
*15-minute presentation each, 15 minutes of Discussion per presentation*

**Session D – Extension Program Planning**, *Grand Ballroom Section 6*

**Discussant and Chair:** Kate Shoulders     **Facilitator:** Mathew Smith

**Organizational Priorities for Advancing Cooperative Extension in the Tampa Bay Area**, Amy Harder, Lendel K. Narine, and A. Ondine Wells

**Examining Rural Community Planning: A Community Viability Indicator (CVI) Model**, Sarah Bush and Rick Rudd

**Good Agricultural Practices Training for Extension Educators and Limited-Resource Produce Growers**, John C. Ricketts and Agnes Kilonzo-Nthnge

**Identifying Generational Differences to Target Extension Programming when Discussing Genetic Modification**, Peyton N. Beattie, Alexa J. Lamm, Joy N. Rumble, and Jason D. Ellis

---

**Session E –Program Evaluation**, *Grand Ballroom Section 2*

**Discussant and Chair:** Edward Osborne     **Facilitator:** Lauren Cline

**Framework for School Garden Program Development and Evaluation: A Delphi approach**, John Diaz, Laura Warner, and Susan Webb

**Laboratory Management Needs of Iowa School-Based Agricultural Mechanics Teachers**, A. Preston Byrd, P. Ryan Saucier, and Ryan G. Anderson

**Exploring the Effect of Personal Norms and Perceived Cost of Water on Conservation**, Amanda D. Ali, Cameron N. Ramey, and Laura A. Warner

**Saving Water in the City: Behavioral Research to Inform Urban Landscape Water Conservation Extension Programs**, Laura A. Warner, John M. Diaz, and Anil Kumar Chaudhary

---

**Session F – Professional Development, *Grand Ballroom Section 1***  
**Discussant and Chair:** Jim Flowers      **Facilitator:** Rachel Ralston

**Developing 21st Century Leadership Skills in County Extension Directors: Exploring Design, Implementation and Evaluation of an Online Leadership Development Program,** Matthew Sowcik, Matt Benge, and Jera Niewoehner Green

**What do they need? Determining Differences in the Classroom-based Professional Development Needs of Louisiana Agriculture Teachers by Years of Teaching Experience,** Whitney L. Figland, J. Joey Blackburn, Eric Smith, and Kristin S. Stair

**Describing the Differences in the Professional Development needs of Traditionally and Alternatively Certified Agriculture Teachers in Louisiana,** Kristin S. Stair, Whitney L. Figland, J. Joey Blackburn, H., and Eric Smith

**Determining Content Knowledge Needs for Professional Development of In-service Agricultural Education Teachers in South Carolina,** Catherine A. DiBenedetto, Victoria C. Willis, and K. Dale Layfield

---

**11:00 – 12:00 p.m.**      **SR-AAAE Business Meeting Session II,** *Grand Ballroom Section 6*

**12:00 – 1:30 p.m.**      **Luncheon and Distinguished Lecture,** *Grand Ballroom Section 4*

**1:45 – 4:00 p.m.**      **Professional Development,** *Grand Ballroom Section 1*

**4:30 – 6:00 p.m.**      **Tennessee Host State Social,** *Conference Center A*

**Dinner on your own**

---

**Tuesday, February 6, 2018**

---

**7:00 – 8:30 a.m.**      **Research Poster Session (*with breakfast*),** *Conference Center A*

**A Survey to Describe the Benefits and Barriers of University of Arkansas Students to Study Abroad,** Olivia Caillouet, Catherine Dobbins, Leslie D. Edgar, and Don W. Edgar

**American Indians: The Under-Underrepresented Population in Agriculture,** Marshall Swafford

**An Assessment of Leadership Competencies: A Difference of Opinion,** Matt Benge, Matthew Sowcik, and Jera Niewoehner-Green

**Animal Welfare Framing on Twitter,** Jefferson Miller and Olivia Norton

**Applying Experiential Learning Principles to Introductory Small Engines Instruction,** Chris Clemons and Trent Wells



**Assessing and Evaluating an Honors Program in a College of Agriculture**, Isabel Whitehead, Leslie D. Edgar, and Don. W. Edgar

**Assessing Critical Thinking Styles of International Faculty**, Catherine A. DiBenedetto and R. Kirby Barrick

**Comparison of Supervisor and Extension Personnel Perceptions of Communication Needs**, Brittany Bowman, Quisto Settle, Elizabeth Gregory North, and Keri Collins Lewis

**Corporate Positions on Animal Welfare: A Content Analysis of Protein Companies' Web Pages**, Sara Maples, Olivia Norton, and Jefferson Miller

**Effects of Activity Type and Gender on Cognitive Achievement in Hydraulics**, Patterson Hilaire, Colton Teekell, and Donald Johnson

**Global Learning Reflection: Evaluating the International Blog Posts of the Virginia Agriculture Leaders Obtaining Results (VALOR) Program**, Chelsea Corkins, Sarah Bush, and Megan Seibel

**Help! Determining the FFA and SAE Professional Development Needs of Louisiana Agriculture Teachers by Years of Teaching Experience**, Krista Courter, Whitney L. Figland, J. Joey Blackburn, Kristin S. Stair, and H. Eric Smith

**Improving Post-Secondary Teaching: Teaching the Future Professor Pedagogy**, Jeremy Elliott-Engel and Donna Westfall-Rudd

**Mississippi State University Extension Personnel Communication Needs Assessment**, Brittany Bowman, Quisto Settle, Elizabeth Gregory North, and Keri Collins Lewis

**Outcomes of a State-wide Service Learning and Leadership Experience for Agriculture Students**, Tobin Redwine

**Perceived Factors that Influence the Success of Vertical Transfer Students in Agricultural Education**, Tera Howerton and Chris Clemons

**Promoting Innovation and Team Performance Through Cognitive Diversity: A case of Extension Agents in Morogoro-Tanzania**, Asha Shayo, Rick Rudd, and Amon Mattee

**Seeking and Engaging: Case Study Integration to Enhance Critical Thinking Style**, Jessica Harsh, Alexa J. Lamm, and Ricky Telg

**Student Preparedness: College Ready or Career Ready?** Victoria C. Willis, Catherine A. DiBenedetto, and Brian E. Myers

**Students' Perceptions of Workforce Readiness Compared to Industry Expectations**, Rachel E. Hendrix and Carley C. Morrison

**Teacher Perception of the Georgia Middle School Agricultural Education Curriculum and its Relationship to Secondary Agricultural Education Enrollment**, David Chapman and James Lindner

**Teaching Enhancement through Agricultural Laboratories Workshop: Effects on Self-Efficacy and Intent to Teach Agricultural Sciences**, Haley Hensley, Catherine Shoulders, Don Edgar, Donna Graham, George Wardlow, and Donald Johnson

**University Faculty Perspective on Student Entitlement**, Don Edgar, Donna Graham, and Leslie Edgar

**Use and Perceptions of Varroa Control Practices Among Florida Backyard Beekeepers**, Mary Bammer, Amanda Ali, Austin Council, and Sebastian Galindo

**Where's the Expert? Understanding the Expertise Gap in Preservice Agricultural Education Teachers**, Lauren Lewis Cline and Marshall Baker

---

**9:00 – 11:00 a.m. Concurrent Research Session III – Higher Education and Evaluation**  
*15-minute presentation each, 15 minutes of Discussion per presentation*

**Session G – Issues in Higher Education**, *City Terrace 4*

**Discussant and Chair:** Cecilia E. Suarez    **Facilitator:** Shasta Charlton

**General Education Plant Pathology Course Increases Science Identity Among Undergraduates in Live and Online Sections**, Kathryn A. Stofer, Brantlee Spakes-Richter, Natalie DelRocco, and Marilyn Boahmah

**Planned Behavior Typologies of Agricultural Education Teacher Educators in Regard to Service-Learning as a Method of Instruction: A National, Mixed Methods Study**, Richie Roberts, M. Craig Edwards, and Toni A. Ivey

**Agricultural and Natural Resource Issues Education: Are We Teaching About Relationships**, Alexa J. Lamm, Jessica Harsh, Courtney Meyers, and Ricky Telg

**Relationship between Student Pre-Entry Attributes and Six-Year Degree Completion**, C. S. Shoulders, L. D. Edgar, and D. M. Johnson

---

**Session H – Teaching and Learning**, *River Terrace 2*

**Discussant and Chair:** JC Bunch    **Facilitator:** Jenna Jones

**Experimental Studies in School-based Agricultural Education from 2006-2016: A Synthesis of the Literature in the Journal of Agricultural Education**, Blake C. Colclasure and Andrew C. Thoron

**Evaluating the VALOR Program: Blogs as a Reflection Process**, Sarah Bush, Chelsea Corkins, Megan Seibel, and Jeremy Elliott-Engel

**Student Perspective of the Desired Roles Educators Play – A Q Methodology Study**, Carley Snider, Joenelle Futrell, and Marshall A. Baker

**Faculty Motivations for Leading Short-term Study Abroad Courses**, Brandon Raczkoski and J. Shane Robinson

---

**Session I – Global Learning, *City Terrace 6***

**Discussant and Chair:** Rick Rudd      **Facilitator:** Nakana Morton

**Examining Cultural Proficiency Among Secondary Agricultural Education Youth Through Intercultural Effectiveness and Global Experiences,** Kendall M. Wright, Courtney A. Turley, and Stacy K. Vincent

**Development and Validation of a Study Abroad Perceived Costs Scale,** Brandon M. Raczowski, Leslie D. Edgar, J. Shane Robinson, Marshall A. Baker, and M. Craig Edwards

**Involving agriculture faculty in study abroad: A descriptive and comparative analysis of faculty involvement in and perceptions of study abroad programs,** Shelli D. Rampold, J.C. Bunch, Melissa Cater, and J. Joey Blackburn

**Involving agriculture faculty in study abroad: An examination of structural relationships between personal dimension variables in involvement,** Shelli D. Rampold, Melissa Cater, J.C. Bunch, and J. Joey Blackburn

---

**11:30 – 1:30 p.m.      Awards Luncheon, *River Terrace 1***

**SR-AAAE Conference Adjourns after Lunch**

## **Reflecting on Experience: The Impact of Reflection Following FFA Civic Engagement Activities**

William A. Bird, University of Tennessee at Martin  
Amanda Bowling, The Ohio State University  
Anna Ball, University of Missouri

Civic engagement activities are utilized to enhance youth's citizenship skills and content knowledge, and to strengthen the community's status. Postactivity reflections can be utilized to strengthen the benefits of civic engagement activities but are often underutilized. This quasi-experimental study sought to determine the influence of guided reflection following FFA civic engagement activities on students' self-perceived civic responsibility. Through the use of a nonequivalent control group pretest-posttest design, four schools and students who participated in FFA civic engagement activities (n = 138) were randomly assigned to either a group discussion after reflection or a no-reflection group. It was found that throughout all time periods, students felt slightly connected to their community, community needs awareness, and civic efficacy. It was also found that the reflection treatment group exhibited statistically significantly higher community needs awareness and civic efficacy construct mean scores than the no-reflection group. It is recommended for FFA chapters to provide a wide variety of short-term civic engagement activities with reflection components.

### **Introduction**

Civic engagement activities unite human efforts and resources toward identifying and correcting existing community problems (Adler & Goggin, 2005; Camino & Zeldin, 2002; Diller, 2001; Jans, 2004). As a result of civic engagement, individuals form stronger bonds with other community members, enhance their sense of community pride, and increase their concern for improving the status of the community (Flanagan & Faison, 2001; Furco, Jones-White, Huesman, & Gorny, 2016). During adolescence, civic values are more likely to take shape as these individuals are far more open to learning civic concepts than in any other period of life; it may be adolescents' last opportunity to develop behaviors as positive contributors to society (Finlay, Wray-Lake, & Flanagan, 2010). Civic engagement allows youth to explore their identity beyond the familial home, acquire the societal norms of the adult world, and provide youth a positive connection to societal improvement (McIntosh, Metz, & Youniss, 2005; Seider, Soutter, & Clark, 2016). To initiate the steps of becoming engaged contributors to society, however, adolescent youth must first be presented the opportunity to become involved in civic engagement activities (Hart & Atkins, 2002; Langston, 1987). If adolescent youth miss the opportunity to become civically involved, their civic capacities in adulthood could be diminished (Finlay, Wray-Lake, Warren, & Maggs, 2014).

Civic engagement activities are often provided in schools and youth programs to enhance youths' citizenship skill development. Educators throughout the United States routinely utilize civic engagement activities to enhance students' content knowledge, develop citizenship skills, and simultaneously strengthen the community's status (Sherrod, 2005; Yates & Youniss, 1999; Youniss & Yates, 1997). FFA chapters can provide numerous civic engagement involvement outlets for youth, commonly offered as community-based service learning or curriculum-based

service learning projects (National FFA Organization, 2016; National FFA Organization, 2017; Ricketts & Ricketts, 2011; Woodward & Rudd, 2016). FFA sponsored civic engagement activities can occur in a variety of ways, including activities such as providing food to those unable to feed themselves, repairing or constructing community structures, or developing a community garden to educate the community on food production (National FFA Organization, 2017). Research indicates that short-term intensive community-based service learning projects support the competence, autonomy, and relatedness of the youth participants and also increases the likelihood of future participation in service projects (Kackar-Cam & Schmidt, 2014). FFA specific civic engagement activities potentially enhance agriculture students' sense of civic responsibility (Brandell & Hinck, 2005; Furco et al., 2016; Skinner & Chapman, 1999).

Civic engagement activities can enhance youths' capabilities as productive community members while simultaneously improving the status of local communities (Lin, 2015; Waterman, 1997). If schools and youth programs intend to develop responsible civic attitudes, it is crucial for these groups to utilize effective methods for facilitating meaningful civic engagement experiences. Civic engagement activities are a widely utilized component at all levels of FFA programming (National FFA Organization, 2016). However, the civic engagement component of FFA programming remains largely unexamined. As a result, current FFA civic engagement practices may not fully maximize students' civic learning and development.

### **Conceptual Framework**

A conceptual model (see Figure 1) was developed using existing youth development and civic engagement literature to guide the current investigation. The conceptual model focuses on the development of civic responsibility through participating in civic engagement activities and postengagement reflections. Civic responsibility encompasses three dimensions: an individual's connection to the community, awareness of existing community needs, and civic efficacy (Balsano, 2005; Evans & Prilleltensky, 2005; Furco, Muller, & Ammons, 1998; Lin, 2015; McGuire & Brown, 2015). Connection to the community represents that an individual perceives interconnectedness to other community members and can relate to other community members (Balsano, 2005; Mondak & Gearing, 1998). Community needs awareness signifies an individual's ability to identify and resolve existing communal issues (Evans & Prilleltensky, 2005). Civic efficacy is the mindset that an individual can and should solve existing community problems (Giles & Eyler, 1994; McGuire & Brown, 2015). Theoretically, youths' sense of civic responsibility increases as a result of civic engagement involvement.

However, the simple act of participating in civic engagement activities does not necessarily maximize civic responsibility development (Bringle & Hatcher, 1999; Finlay et al., 2014). A critical component to successful, meaningful, and developmentally constructive civic engagement involves time for youth to critically process the civic engagement experience using structured postactivity reflection (Billig, 2000; Mitchell et al., 2015). Civic engagement reflection has been defined as an activity that "connects the experience with content, skills, and values" of youth to the larger community through meaningful reflective dialogue (Billig, 2000, p. 662). The form of civic engagement reflections varies greatly, including reflective papers, journals, group projects, presentations, group discussions, peer debriefing, and one-on-one discussions (Blyth, Saito, & Berkas, 1997). Regardless of form, structured reflection requires youth to consciously examine, collaborate, and contemplate what occurred during the civic

engagement activity as well as how the experience will impact them in the future (Bringle & Hatcher, 1999; Mitchell et al., 2015). The civic engagement experience, and ultimate learning, becomes more meaningful when youth critically assess the experience to create new ideals, beliefs, or viewpoints (Eyler & Giles, 1997).

Meaningful and effective civic engagement reflection includes three components (Bradley, 1997). The first component of structured guided reflection is conceptualization. Reflection links an individual’s understanding of concrete events to more abstract conceptualizations beyond themselves (Camino & Zeldin, 2000; Conway, Amel, & Gerwein, 2009; Terry & Bohnenberger, 2004). Formally implemented structured reflection offers a more consistent level of cognitive processing for all involved youth (Eyler & Giles, 1997). Structured reflection also provides a more equal opportunity for all youth to process the experience and ultimately reach higher levels of understanding. The second component of structured guided reflection is the realization of ability and impact. Most event reflection by youth increases their personal investment for improving community problems and allows them to have a more powerful intellectual experience when consistently utilized (Eyler, Giles, & Braxton, 1995; Greene & Diehm, 1995). The final component of structured guided reflection is transfer to future situations. Reflection must objectively direct youth to think about the implications of their civic engagement experiences. Adults should guide youths’ thinking so as to transfer what is learned from the civic engagement experience to other situations (Hofer, 1999; Mitchell et al., 2015). Youth will derive little meaning from ambiguous reflection and will fail to consider the experience in more global ways (Bringle & Hatcher, 2004).

Civic engagement activities should include a meaningful and thoughtfully structured postactivity reflection component (Waterman, 1997). Post-civic engagement reflection enhances youths’ conceptualization of the civic engagement experience, realization of civic impact, and transfer of knowledge to future civic situations (Bringle & Hatcher, 1999). If civic engagement experiences lack reflection, students may not reach their full developmental potential (Blyth et al., 1997; Hatcher & Bringle, 1997). The utilization and effect of reflection within FFA civic engagement programming holds great potential but remains largely unexplored.

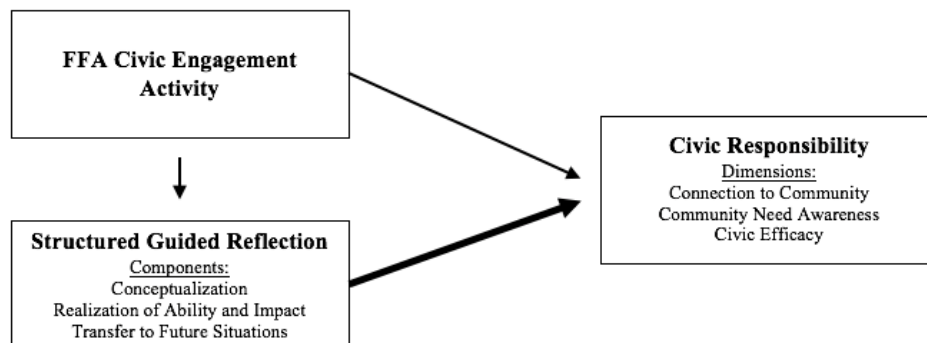

Figure 1. Conceptual model of critical components during FFA civic engagement activities.

## Purpose

The purpose of this study was to determine the influence of guided reflection following FFA civic engagement activities on students' self-perceived civic responsibility. The research specifically addressed the National Research Agenda Research Priority Area 6: Vibrant, Resilient Communities (Roberts, Harder, & Brashears, 2016). The following research objectives and null hypothesis were generated to guide the study:

1. Describe students' self-perceived levels of civic responsibility.
2. Compare the effect of post-civic engagement reflection on students' levels of civic responsibility.

$H_0: \mu \text{ Reflection} = \mu \text{ No reflection}$

In the population, no statistical difference exists within the students' level of civic responsibility based upon the level of post-civic engagement reflection.

## Methods

This study utilized a quasi-experimental, nonequivalent control group pretest-posttest design (see Table 1; Ary, Jacobs, & Sorensen, 2010; Shadish, Cook, & Campbell, 2002). The nonequivalent control group pretest-posttest design is appropriate because subjects within intact existing groups, such as FFA chapters, cannot be randomly assigned to groups to establish equality (Shadish et al., 2002). The design utilized four data collection points: November, Year 1; May, Year 2; November, Year 2; and March, Year 3. We gathered data on the same unit of student subjects, making it a dependent samples design. Four schools were selected for participation because they consistently provided FFA sponsored civic engagement activities lacking a reflection component. Upon conclusion of the third data collection point, schools were randomly assigned to the control or experimental groups. Two FFA chapters were randomly assigned to provide a group discussion format reflection following FFA civic engagement activities after Period 3; the other two FFA chapters continued providing FFA civic engagement activities without reflection. FFA advisors of the programs selected for the reflection treatment group were provided training on reflection protocol expectations as well as scripted reflection questions to ask students immediately following civic engagement activities. The participating schools provided the researcher a sample of 372 students. Students who participated in FFA civic engagement activities before and after the treatment assignment ( $n = 138$ ) were the final usable sample from which data was gathered during all four periods. The final usable sample ( $n = 138$ ) were students who participated in at least one FFA civic engagement activity during each time period. We viewed these students as a time and place sample and deemed the results inferable to past and future individuals within the four FFA chapters (Oliver & Hinkle, 1982). Respondents self-reported themselves as mostly 15 years old, male, in 9th grade, white, lived on a rural farm, and had grades of mostly A's and B's.

Table 1  
*Graphic Representation of the Research Design*

Group	Pretest			Assignment	Treatment	Posttest
	Period 1	Period 2	Period 3			Period 4
School 1	$O_1$	$O_2$	$O_3$	Random	Control	$O_4$
School 2	$O_1$	$O_2$	$O_3$	Random	Control	$O_4$
School 3	$O_1$	$O_2$	$O_3$	Random	$X_{\text{Reflection}}$	$O_4$
School 4	$O_1$	$O_2$	$O_3$	Random	$X_{\text{Reflection}}$	$O_4$

The teacher-facilitated reflection treatment protocol was adapted from the Six Step Civic Reflection Process (Bradley, 1997) and provided a consistent treatment among treatment group subjects. Students recorded data using a paper and pencil form of the Civic Responsibility Scale (Furco et al., 1998) to measure students' levels of self-perceived civic responsibility. Responses were based on a six-point Likert-type scale with anchors of 1 = *Strongly Disagree*, 2 = *Disagree*, 3 = *Slightly Disagree*, 4 = *Slightly Agree*, 5 = *Agree*, and 6 = *Strongly Agree*. A panel of seven experts recommended changes to enhance the face validity of the instrument. A pilot test ( $n = 28$ ) with a similar population not included in the study revealed acceptable Cronbach's alpha reliability estimates ranging from 0.72 to 0.93 (Nunnally, 1978).

We used descriptive statistics to analyze the findings for Research Objective 1. For Research Objective 2, We used analyses of covariance (ANCOVA) to compare groups' mean scores in order to test the null hypothesis. First, We used a Levene's test of equality of variance to test the homogeneity of variance assumption. They tested the null hypothesis stating that no differences existed in the error variance between treatment groups for the connection to community construct ( $F_{1,136} = 0.15, p = .70$ ), community needs awareness construct ( $F_{1,136} = 0.01, p = .93$ ), and civic efficacy ( $F_{1,136} = 0.04, p = .84$ ). The differences of error variances were not statistically significant for any construct; the assumption of homogeneity of variance was tenable. For all statistical analyses, alpha levels were set a priori at  $\alpha = 0.05$ .

### Findings

Research Objective 1 sought to describe students' levels of self-perceived civic responsibility. Civic responsibility was operationally defined as (a) connection to the community—students felt they had a relationship with their community; (b) community needs awareness—students felt they could identify existing societal issues; and (c) civic efficacy—students felt they had the skills and ability to influence community issues in a positive way. Table 2 displays the means and standard deviations for civic responsibility constructs by school for each time period as well as the summated civic responsibility construct scores. In regard to the connection to the community construct, students from School 1 ( $M = 4.58; SD = 0.77$ ) and School 4 ( $M = 4.73; SD = 1.00$ ) reported an overall response of agree. Respondents indicated they slightly agreed with the connection to the community at School 3 ( $M = 4.48; SD = 0.84$ ) and School 2 ( $M = 4.22; SD = 0.86$ ). Students from all four schools slightly agreed with the community needs awareness construct. The community needs awareness construct means scores ranged from 3.59 ( $SD = 0.89$ )



to 4.29 ( $SD = 1.00$ ) across all schools. Students from School 4 reported the highest overall level of community needs awareness ( $M = 4.29$ ;  $SD = 1.00$ ) among all schools, followed by students from School 1 ( $M = 4.58$ ;  $SD = 0.77$ ), students from School 3 ( $M = 3.99$ ;  $SD = 0.88$ ), and students from School 2 ( $M = 3.59$ ;  $SD = 0.89$ ). Students from School 1 ( $M = 4.16$ ;  $SD = 0.92$ ), School 3 ( $M = 3.84$ ;  $SD = 0.97$ ), and School 4 ( $M = 4.28$ ;  $SD = 1.02$ ) responded overall with slightly agree when presented with the civic efficacy construct. Students from School 2 reported the lowest levels of agreement with the continued participation construct, responding that overall they slightly disagree ( $M = 3.40$ ;  $SD = 0.96$ ).

Table 2

*Students' Self-Perceived Levels of Civic Responsibility (n = 282)*

Civic responsibility construct	Period 1			Period 2			Period 3			Period 4			Total		
	<i>n</i>	<i>M</i>	<i>SD</i>	<i>n</i>	<i>M</i>	<i>SD</i>	<i>n</i>	<i>M</i>	<i>SD</i>	<i>n</i>	<i>M</i>	<i>SD</i>	<i>n</i>	<i>M</i>	<i>SD</i>
School 1															
Connection to the community	58	4.78	0.80	41	4.70	0.76	55	4.45	0.99	58	4.53	0.89	58	4.58	0.77
Community needs awareness	58	4.42	0.81	41	4.30	0.96	55	4.12	1.08	58	4.18	0.89	58	4.20	0.84
Civic efficacy	58	4.27	1.02	41	4.26	1.03	55	4.08	1.11	58	4.24	0.92	58	4.16	0.92
School 2															
Connection to the community	59	4.49	0.93	58	4.15	1.08	59	4.10	1.02	59	4.15	1.11	59	4.22	0.86
Community needs awareness	59	3.79	1.06	58	3.53	1.12	59	3.46	1.02	59	3.62	1.17	59	3.59	0.89
Civic efficacy	59	3.66	1.07	58	3.20	1.24	59	3.34	1.17	59	3.43	1.24	59	3.40	0.96
School 3															
Connection to the community	137	4.61	0.85	121	4.51	0.92	127	4.39	1.01	137	4.46	1.07	137	4.48	0.84
Community needs awareness	137	4.02	0.86	121	3.99	0.99	127	3.96	1.04	137	4.06	1.13	137	3.99	0.88
Civic efficacy	137	3.89	1.01	121	3.85	1.02	127	3.76	1.17	137	3.92	1.21	137	3.84	0.97
School 4															
Connection to the community	27	4.97	0.63	27	4.83	0.91	28	4.83	0.74	28	4.68	1.21	28	4.73	1.00
Community needs awareness	27	4.38	0.65	27	4.49	0.85	28	4.29	0.93	28	4.35	1.26	28	4.29	1.00
Civic efficacy	27	4.20	0.98	27	4.41	1.02	28	4.27	1.26	28	4.44	1.19	28	4.28	1.02

Civic responsibility construct scores for each school were collapsed within each time period to form summated construct scores (see Table 3). The summated levels of students' self-perceived civic responsibility among all schools revealed that students slightly agreed they had feelings of connection to the community ( $M = 4.47$ ;  $SD = 0.85$ ), community needs awareness ( $M = 3.98$ ;  $SD = 0.91$ ), and civic efficacy ( $M = 3.86$ ;  $SD = 1.00$ ).

Table 3  
*Summated Levels of Students' Self-Perceived Civic Responsibility Among All Schools (n = 282)*

Civic responsibility construct	Period 1 (n = 282)		Period 2 (n = 247)		Period 3 (n = 269)		Period 4 (n = 282)		Total (n = 282)	
	M	SD	M	SD	M	SD	M	SD	M	SD
Connection to the community	4.66	0.84	4.49	0.95	4.38	1.00	4.43	1.07	4.47	0.85
Community needs awareness	4.09	0.91	3.99	1.04	3.92	1.06	4.02	1.13	3.98	0.91
Civic efficacy	3.96	1.04	3.83	1.14	3.79	1.19	3.93	1.20	3.86	1.00

*Note.* Coded: 1–1.50 = *Strongly Disagree*, 1.51–2.50 = *Disagree*, 2.51–3.50 = *Slightly Disagree*, 3.51–4.50 = *Slightly Agree*, 4.51–5.50 = *Agree*, and 5.51–6 = *Strongly Agree*.

Objective 2 sought to compare the effect of a post-civic engagement reflection on students' civic responsibility. The researcher used ANCOVA to compare group mean scores and test the null hypothesis. Civic responsibility scores for time Periods 1 through 3 were collapsed into a single pretreatment civic responsibility score for comparison to the single posttreatment civic responsibility score. Summary statistics for treatment groups were calculated for comparison of all subjects ( $n = 138$ ).

### **Connection to Community**

As shown in Table 4, students in the no reflection group had an overall pretreatment connection to community construct mean score of 4.66 ( $SD = 0.78$ ) and an overall posttreatment connection to community construct mean score of 4.50 ( $SD = 0.98$ ). Students in the reflection group had an overall pretreatment connection to community construct mean score of 4.68 ( $SD = 0.75$ ) and an overall posttreatment connection to community construct mean score of 4.71 ( $SD = 0.94$ ).

Table 4

*Comparison of Pretreatment and Posttreatment Connection to Community Construct Mean Scores between No Reflection and Reflection Groups (n = 138)*

Group	n	Pretreatment				Posttreatment			
		M	SD	Range		M	SD	Range	
				Min	Max			Min	Max
No Reflection	53	4.66	0.78	1.00	6.00	4.50	0.98	1.00	6.00
Reflection	85	4.68	0.73	1.00	6.00	4.71	0.94	1.00	6.00
Total	138	4.67	0.75	1.00	6.00	4.63	0.96	1.00	6.00

*Note.* Coded: 1–1.50 = *Strongly Disagree*, 1.51–2.50 = *Disagree*, 2.51–3.50 = *Slightly Disagree*, 3.51–4.50 = *Slightly Agree*, 4.51–5.50 = *Agree*, and 5.51–6 = *Strongly Agree*.

We tested the null hypothesis for the connection to community construct using ANCOVA and used students' pretreatment connection to community construct scores as the covariate (see Table 5). The  $F$ -value ( $F_{2,135} = 2.52, p = .12$ ) was not statistically significant, indicating there was no difference among students' connection to community construct scores between treatment groups when controlling for pretreatment connection to community construct scores.

Table 5

*Analysis of Covariance (ANCOVA) in Connection to Community Construct Scores by Treatment Group (n = 138)*

Source	Sum of Squares	df	Mean Square	F	p
Treatment Group	1.19	1	1.19	2.52	.12
Covariate	60.23	1	60.23	127.38	.01*
Error	63.83	135			

*Note.* Adjusted  $R^2 = 0.48$ ; \* $p \leq .05$ .

### Community Needs Awareness

As shown in Table 6, students in the no reflection group had an overall pretreatment community needs awareness construct mean score of 4.20 ( $SD = 0.85$ ) and an overall posttreatment community needs awareness construct mean score of 4.10 ( $SD = 1.07$ ). Students in the reflection group had an overall pretreatment community needs awareness construct mean score of 4.23 ( $SD = 0.74$ ) and an overall posttreatment community needs awareness construct mean score of 4.41 ( $SD = 1.03$ ).

Table 6

*Comparison of Pretreatment and Posttreatment Community Needs Awareness Construct Mean Scores between No Reflection and Reflection Groups (n = 138)*

Group	n	Pretreatment				Posttreatment			
		M	SD	Range		M	SD	Range	
				Min	Max			Min	Max
No reflection	53	4.20	0.85	1.00	6.00	4.10	1.07	1.00	6.00
Reflection	85	4.23	0.74	1.00	6.00	4.41	1.03	1.00	6.00
Total	138	4.22	0.78	1.00	6.00	4.30	1.05	1.00	6.00

*Note.* Coded: 1–1.50 = *Strongly Disagree*, 1.51–2.50 = *Disagree*, 2.51–3.50 = *Slightly Disagree*, 3.51–4.50 = *Slightly Agree*, 4.51–5.50 = *Agree*, and 5.51–6 = *Strongly Agree*.

We tested the null hypothesis for the community needs awareness construct using ANCOVA and used students' pretreatment community needs awareness construct scores as the covariate (see Table 7). The  $F$ -value ( $F_{2,135} = 4.44$ ,  $p = .04$ ,  $\eta^2 = 0.02$ ) was statistically significant, indicating a significant difference existed among students' community needs awareness construct scores between treatment groups when controlling for pretreatment community needs awareness construct scores.

Table 7

*Analysis of Covariance (ANCOVA) in Community Needs Awareness Construct Scores by Treatment Group (n = 138)*

Source	Sum of Squares	df	Mean Square	F	p
Treatment group	2.53	1	2.53	4.44	.04*
Covariate	72.29	1	72.29	126.98	.01*
Error	76.8863	135			

*Note.* Adjusted  $R^2 = 0.49$ ; \* $p \leq .05$ .

### Civic Efficacy

As shown in Table 8, students in the no reflection group had an overall pretreatment civic efficacy construct mean score of 4.15 ( $SD = 0.89$ ) and an overall posttreatment civic efficacy construct mean score of 4.11 ( $SD = 1.05$ ). Students in the reflection group had an overall pretreatment civic efficacy construct mean score of 4.10 ( $SD = 0.93$ ) and an overall posttreatment civic efficacy construct mean score of 4.35 ( $SD = 1.12$ ).

Table 8

*Comparison of Pretreatment and Posttreatment Civic Efficacy Construct Mean Scores between No Reflection and Reflection Groups (n = 138)*

Group	n	Pretreatment				Posttreatment			
		M	SD	Range		M	SD	Range	
				Min	Max			Min	Max
No reflection	53	4.15	0.89	1.00	6.00	4.11	1.05	1.00	6.00
Reflection	85	4.10	0.93	1.00	6.00	4.35	1.12	1.00	6.00
Total	138	4.12	0.91	1.00	6.00	4.26	1.09	1.00	6.00

*Note.* Coded: 1–1.50 = *Strongly Disagree*, 1.51–2.50 = *Disagree*, 2.51–3.50 = *Slightly Disagree*, 3.51–4.50 = *Slightly Agree*, 4.51–5.50 = *Agree*, and 5.51–6 = *Strongly Agree*.

The null hypothesis for the civic efficacy construct was tested using ANCOVA and used students' pretreatment civic efficacy construct scores as the covariate (see Table 9). The  $F$ -value ( $F_{2,135} = 5.02, p = .03, \eta^2 = 0.02$ ) was statistically significant, indicating a significant difference existed among students' civic efficacy construct scores between treatment groups when controlling for pretreatment civic efficacy construct scores.

Table 9

*Analysis of Covariance (ANCOVA) in Civic Efficacy Construct Scores by Treatment Group (n = 138)*

Source	Sum of Squares	df	Mean Square	F	p
Treatment group	2.78	1	2.78	5.02	.03*
Covariate	87.39	1	87.39	157.81	.01*
Error	74.76	135			

*Note.* Adjusted  $R^2 = 0.54$ ; \* $p \leq .05$ .

We rejected the null hypothesis stating that no difference existed between the groups' levels of civic responsibility in favor of the research hypothesis. Summary statistics for treatment group comparisons indicated students who participated in FFA civic engagement activities and also experienced post-civic engagement reflection had significantly higher levels of civic responsibility.

### Conclusions, Implications, and Recommendations

Regarding Research Objective 1, throughout all time periods, students slightly agreed with feeling connected to their community, possessed slight community needs awareness, and slight civic efficacy. We concluded that, overall, students viewed themselves as somewhat responsible for the well-being of their immediate communities. All students' levels of self-perceived civic responsibility decreased throughout the first three time periods; students' levels of self-perceived

civic responsibility increased from Period 3 to Period 4. We also concluded that students' self-perceived levels of civic responsibility had a tendency to decrease over time.

The results regarding students' levels of self-perceived civic responsibility suggest that students possess positive civic attitudes related to civic responsibility; however, youth don't necessarily feel strongly about their role as a responsible community member. It can be implied that there is room for improvement in civic attitudes with this group of students. These students' civic attitudes are positive, but not necessarily strong.

Students reported decreasing trends in self-perceived civic responsibility over time. Several implications can be made from this conclusion. First, adolescence is a developmental time period when youth experiment and come to know the adult world beyond their immediate home (Dwyer & Hunt-Jackson, 2002; Lerner, 2009). Adolescent youth may naturally develop a more critical perception of their own civic attitudes based upon civic engagement experiences (Levine & Higgins-D'Alessandro, 2010). Second, none of these FFA chapters provided a post-civic engagement reflection component prior to Period 4. A final explanation of students' decreasing levels of civic responsibility could be that a lack of reflection following civic engagement reduces students' civic attitudes. Civic engagement without reflection can be harmful to youths' civic attitudes (Blyth et al., 1997). In other words, FFA civic engagement activities without reflection could potentially do more harm than good to students' civic attitudes. Finally, the decrease in civic responsibility scores could be attributed simply to test wiseness of the subjects in the study.

Regarding Research Objective 2, students in both treatment groups displayed similar pretreatment scores for each civic responsibility construct. The differences between the treatment groups' mean pretreatment civic responsibility construct scores ranged from 0.02 to 0.05. We concluded that students had similar levels of self-perceived civic responsibility construct scores prior to the experimental treatment. It should be noted that although this study sought to control variance differences between groups by utilizing a quasi-experimental design, it is not possible to entirely account for all prior experiences and reflection levels of subjects. This limitation should be considered when interpreting these results. We operated under the assumption that prior experiences were generally homogenous among all subjects.

Differences existed between posttreatment civic responsibility construct scores when controlling for pretreatment civic responsibility construct scores. Students in the reflection treatment group displayed higher average scores than the no reflection group for all three civic responsibility construct scores. The reflection groups' posttreatment connection to community construct score was 0.21 higher than the no reflection group, but the difference between means was not statistically significant. The reflection treatment group exhibited significantly higher community needs awareness and civic efficacy construct mean scores than the no reflection group. We concluded that students who experienced a structured reflection following FFA civic engagement activities gained higher levels of self-perceived civic responsibility. The positive influence of structured reflection aligns with the works of numerous scholars supporting the benefits of post-civic engagement reflection (Bringle & Hatcher, 1999; Camino & Zeldin, 2000; Conway et al., 2009; Stafford, Boyd, & Lindner, 2003; Terry & Bohnenberger, 2004; Youniss & Yates, 1997).

However, this finding provides the first empirical support of structured student reflection within FFA civic engagement programming.

Finally, students in the reflection group displayed an increase in mean scores among all three constructs of civic responsibility from pretreatment to posttreatment measures. Conversely, students in the no reflection group showed a decrease in all three constructs from the pretreatment to posttreatment measures. We concluded that youth decline in their level of self-perceived civic responsibility when not provided a structured reflection following FFA civic engagement activities. This conclusion supports existing literature stating that youth can develop less responsible attitudes from civic engagement lacking a reflection component (Blyth et al., 1997). This finding is also a unique contribution to youth development programming within FFA programming.

The conclusions implied that reflection components of civic engagement can potentially serve as a valuable pedagogical tool within FFA programming. Through reflection, youth can enhance their connection with their community, their awareness of community needs, and their efficacy toward improving community issues. While benefits of civic engagement reflection exist, civic engagement opportunities provided at the local, state, or national levels rarely promote or provide reflection components (National FFA Organization, 2016). Additionally, the participating FFA chapters did not routinely utilize structured reflection prior to treatment group assignments. It could be implied that while adult FFA leaders recognize the importance of civic engagement, they are unaware of the value of reflection for student development. It could be further implied that adult FFA leaders lack the resources or skills necessary to conduct civic engagement based reflection sessions with youth.

Secondly, the differences between treatment groups were all positive, and two of the three were statistically significant. Some scholars and practitioners may argue that these differences are impractical. However, the treatment length lasted less than four months, a relatively short period of time compared to long-term civic engagement and reflection models (Bringle & Hatcher, 1999; Waterman, 1997). Thus, FFA civic engagement activities that utilize reflection for periods of time longer than four months could deliver more significant impact on students' self-perceived level of civic responsibility (Bringle & Hatcher, 2004).

Finally, the conclusions suggest that FFA civic engagement activities without reflection actually reduce the students' level of civic responsibility. It can be implied from this that students may actually lose citizenship skills purported to be gained during FFA civic engagement activities if they are not allowed to reflect on their civic engagement experiences. No reflection following FFA civic engagement activities could lead to youth becoming less effective community members (Blyth et al., 1997).

From the conclusions and implications, is it recommended for FFA chapters to provide a wide range of short-term civic engagement activities that incorporate long-term reflection components. Post-civic engagement reflections will allow youth to thoughtfully examine their experiences and will be more likely to gain positive citizenship attitudes. Adult FFA leaders should develop a comprehensive plan to connect each civic engagement activity and allow the reflections to scaffold the youths' civic responsibility. The National FFA Organization, state



staff, and teacher educators should provide professional development for in-service teachers to engage them in impactful civic engagement activities that incorporate post-activity reflections. Teacher educators should also focus on incorporating lessons that emphasize the importance of immersing youth in civic engagement and strengthen civic responsibility through developed reflections. The preservice lessons and in-service professional development workshops should focus on developing the teachers' ability to develop nonformal student reflections, which connect the various civic engagement experiences students have outside of the agriculture classroom.

It is also recommended that this study be replicated on a larger sample and should utilize more rigorous sampling methods. Researchers should also further define the various types of civic engagement activities. Such an investigation could examine whether certain civic engagement activities are more impactful on youths' civic responsibility development than others. Researchers should also investigate the effectiveness of different post-civic engagement reflection approaches. The type of reflection utilized in the current study consisted of a teacher-led group discussion with students following FFA civic engagement activities. Other types of reflection may be more effective to enhancing students' civic attitudes.

## References

- Adler, R. P., & Goggin, J. (2005). What do we mean by “civic engagement”? *Journal of Transformative Education*, 3(3), 236–253. doi:10.1177/1541344605276792
- Ary, D., Jacobs, L. C., & Sorensen, C. (2010). *Introduction to research in education*. Belmont, CA: Wadsworth Cengage Learning.
- Balsano, A. D. (2005). Youth civic engagement in the United States: Understanding and addressing the impact of social impediments on positive youth and community development. *Applied Developmental Science*, 9(4), 188–201. doi:10.1207/s1532480xads0904\_2
- Billig, S. H. (2000). Research on K-12 school-based service-learning: The evidence builds. *Phi Delta Kappan*, 81(9), 658–664.
- Blyth, D. A., Saito, R., & Berkas, T. (1997). A quantitative study of the impact of service-learning programs. In A. S. Waterman (Ed.), *Service-learning: Applications from the research* (pp. 39–56). Mahwah, NJ: Lawrence Erlbaum Associates, Inc.
- Bradley, L. R. (1997). Evaluating service-learning: Toward a new paradigm. In A. S. Waterman (Ed.), *Service-learning: Applications from the research* (pp. 151–172). Mahwah, NJ: Lawrence Erlbaum Associates, Inc.
- Brandell, M. E., & Hinck, S. (2005). Service learning: Connecting citizenship with the classroom. *Journal of Service Learning*, 81(591), 49–56. doi:10.1177/019263659708159109
- Bingle, R. G., & Hatcher, J. A. (1999). Reflection in service learning: Making meaning of experience. *Educational Horizons*, 77, 179–185.
- Bingle, R. G., & Hatcher, J. A. (2004). Designing effective reflection: What matters to service learning?. *Michigan Journal of Community Service Learning* 11(1), 38 -46.
- Camino, L., & Zeldin, S. (2002). From periphery to center: Pathways for youth civic engagement in the day-to-day life of communities. *Applied Developmental Science*, 6(4), 212–219. doi:10.1207/S1532480XADS0604\_8
- Conway, J. M., Amel, E. L., & Gerwein, D. P. (2009). Teaching and learning in the social context: A meta-analysis of service learning effects on academic, personal, social, and citizenship outcomes. *Teaching of Psychology*, 36(4), 233–245. doi:10.1080/00986280903172969
- Diller, E. C. (2001). *Citizens in service: The challenge of delivering civic engagement training to national service programs*. Washington, DC: Corporation for National and Community Service.

- Dwyer, D., & Hunt-Jackson, J. (2002). The life span perspective. In J. S. Wodarski & S. F. Dziegielewski (Eds.), *Human behavior and the social environment: Integrating theory and evidence-based practice* (pp. 84–109). New York, NY: Springer Publishing Company, Inc.
- Evans, S., & Prilleltensky, I. (2005). Youth civic engagement. In M. Ungar (Ed.), *Handbook of working with children and youth: Pathways to resilience across cultures and contexts* (pp. 405–415). Thousand Oaks, CA: Sage Publications.
- Eyler, J., & Giles, D. E. (1997). The importance of program quality in service-learning. In A. S. Waterman (Ed.), *Service-learning: Applications from the research* (pp. 57–76). Mahwah, NJ: Lawrence Erlbaum Associates, Inc.
- Eyler, J., Giles, D. E., & Braxton, J. (1995). The impact of alternative models of service-learning on student outcomes. Paper presented at the meeting of the National Society for Experiential Education, New Orleans, LA.
- Finlay, A., Wray-Lake, L., & Flanagan, C. A. (2010). Civic engagement during the transition to adulthood: Developmental opportunities and social policies at a critical juncture. In L. R. Sherrod, J. Torney-Purta, & C. A. Flanagan (Eds.), *Handbook of research on civic engagement in youth* (pp. 277–306). Hoboken, NJ: John Wiley & Sons, Inc.
- Finlay, A., Wray-Lake, L., Warren, M., & Maggs, J. (2014). Anticipating their future: Adolescent values for the future prediction of adult behaviors. *International Journal of Behavioral Development*, 39(1), 359–367. doi: 10.1177/0165025414544231
- Flanagan, C., & Faison, N. (2001). Youth civic development: Implications of research for social policy and programs. *Social Policy Report*, 15(1), 3–15.
- Furco A., Jones-White D., Huesman R., Gorny L. (2016) Modeling the influence of service-learning on academic and sociocultural gains: Findings from a multi-institutional study. In K. Soria & T. Mitchell (Eds.) *Civic engagement and community service at research universities*. Palgrave Studies in Global Citizenship Education and Democracy (pp. 143–163). Palgrave Macmillan, London. doi: [https://doi.org/10.1057/978-1-137-55312-6\\_8](https://doi.org/10.1057/978-1-137-55312-6_8)
- Furco, A., Muller, P., & Ammons, M. (1998). *Pre-post civic responsibility survey*. Berkeley, California: Service Learning Research and Development Center.
- Giles, D. E., & Eyler, J. (1994). The impact of a college community service laboratory on students' personal, social, and cognitive outcomes. *Journal of Adolescence*, 17(4), 327–339. doi:10.1006/jado.1994.1030
- Greene, D., & Diehm, G. (1995). Educational and service outcomes of a service integration effort. *Michigan Journal of Community Service Learning*, 2, 54–62.

- Hart, D., & Atkins, R. (2002). Civic competence in urban youth. *Applied Developmental Science, 6*(4), 227–236. doi:10.1207/S1532480XADS0604\_10
- Hatcher, J. A., & Bringle, R. G. (1997). Reflection: Bridging the gap between service and learning. *College Teaching, 45*(4), 153–158. doi:10.1080/87567559709596221
- Hofer, M. (1999). Community service and social cognitive development in German adolescents. In J. Yates & M. Youniss (Eds.), *Roots of civic identity* (pp. 114–134). New York, NY: Cambridge University Press.
- Jans, M. (2004). Children as citizens: Towards a contemporary notion of child participation. *Childhood, 11*(1), 27–44. doi:10.1177/0907568204040182
- Kackar-Cam, H., & Schmidt, J. A. (2014). Community-based service-learning as a context for youth autonomy, competence, and relatedness. *The High School Journal, 98*(1), 83–108.
- Langston, S. (1987). Strengthening citizen participation. *National Civic Review, 76*(1), 225–226. doi: <http://dx.doi.org/10.1017/S1537592708080584>
- Lerner, R. (2009). *The positive youth development perspective: Theoretical and empirical bases of strengths-based approach to adolescent development*. In S. Lopez & C. Snyder (Eds.), *Oxford handbook of positive psychology* (pp. 149–163). New York, NY: Oxford University Press.
- Levine, P., & Higgins-D'Alessandro, A. (2010). Youth civic engagement: Normative issues. In L. R. Sherrod, J. Torney-Purta, & C. A. Flanagan (Eds.), *Handbook of research on civic engagement in youth* (pp. 115–138). Hoboken, NJ: John Wiley & Sons, Inc.
- Lin, A. (2015). *Citizenship education in American schools and its role in developing civic engagement: A review of the research*. *Educational Review, 67*(1), 35–63. doi: <http://dx.doi.org/10.1080/00131911.2013.813440>
- McGuire, J. K., & Brown, M. (2015). Types and conditions of service learning. In J. Field, B. Schmidt-Hertah, & A. Waxenegger (Eds.), *Universities and engagement: International perspectives on higher education and lifelong learning* (pp. 117–129). New York, NY: Routledge, Taylor, & Francis Group.
- McIntosh, H., Metz, E., & Youniss, J. (2005). Community service and identity formation in adolescents. In J. Mahoney, R. Larson, & J. Eccles (Eds.), *Organized activities as contexts of development: Extracurricular activities, after-school, and community programs* (pp. 331–351). Mahwah, NJ: Lawrence Erlbaum Associates, Inc.
- Mitchell, T. D., Richard, F. D., Battistoni, R. M., Rost-Banik, C., Netz, R., & Zakoske, C. (2015). Reflective practice that persists: Connections between reflection in service-learning programs and in current life. *Michigan Journal of Community Service Learning, 21*(2), 49–63. doi:

- Mondak, J. J., & Gearing, A. F. (1998). Civic engagement in a post-communist state. *Political Psychology, 19*(3), 615-637. doi:10.1111/0162-895X.00121
- National FFA Organization. (2016). *Official FFA manual*. Indianapolis, IN: National FFA Organization.
- National FFA Organization. (2017). Retrieved from [www.ffa.org](http://www.ffa.org).
- Nunnally, J. C. (1978). *Psychometric theory*. New York, NY: McGraw-Hill.
- Oliver, J. D., & Hinkle, D. E. (1982). Occupational education research: Selecting statistical procedures. *Journal of Studies in Technical Careers, 4*(3), 199–207.
- Ricketts, C., & Ricketts, J. C. (2011). *Leadership: Personal growth and career success*. Clifton Park, NY: Delmar.
- Roberts, T. G., Harder, A., & Brashears, M. T. (Eds.). (2016). *American Association for Agricultural Education national research agenda: 2016-2020*. Gainesville, FL: Department of Agricultural Education and Communication.
- Seider, S., Soutter, M., & Clark, S. (2016). The role of character and character education in fostering student success at school. In K. R. Wentzel & G. B. Ramani (Eds.), *Handbook of social influences in school contexts: Social-emotional, motivation, and cognitive outcomes* (pp. 293–311). New York, NY: Routledge, Taylor, & Francis Group.
- Shadish, W. R., Cook, T. D., & Campbell, D. T. (2002). *Experimental and quasi experimental designs for generalized causal inference*. Boston, MA: Houghton Mifflin Company.
- Sherrod, L. (2005). Ensuring liberty by promoting youth development. *Human Development, 48*(6), 376–381. doi:10.1159/000088256
- Skinner, R., & Chapman, C. (1999). *National student service-learning and community service survey*. Washington, DC: U.S. Department of Education.
- Stafford, J. R., Boyd, B. L., & Lindner, J. R. (2003). The effects of service learning on leadership life skills of 4-H members. *Journal of Agricultural Education, 44*(1), 10–21. doi:10.5032/jae.2003.01010
- Terry, A. W., & Bohnenberger, J. E. (2004). Blueprint for incorporating service learning: A basic, developmental, K-12 service learning typology. *Journal of Experiential Education, 27*(1), 15–31.
- Waterman, A. S. (1997). An overview of service-learning and the role of research and evaluation in service-learning programs. In A. S. Waterman (Ed.), *Service-learning: Applications from the research* (pp. 39–56). Mahwah, NJ: Lawrence Erlbaum Associates, Inc.

- Woodward, L., & Rudd, R. (2016). Service learning impacts and application in agricultural education. *The Agricultural Education Magazine*, 89(1), 9.
- Yates, M., & Youniss, J. (1999). Promoting identity development: Ten ideas for school-based service programs. In J. Claus & C. Ogden (Eds.), *Service learning for youth empowerment and social change* (pp. 43–68). New York, NY: Peter Lang Publishing, Inc.
- Youniss, J. & Yates, M. (1997). *Community service and social responsibility in youth: Theory and policy*. Chicago, IL: University of Chicago Press.

# **Deterrents to Service-Learning's Use as a Method of Instruction in the Preparation of Agricultural Education Teachers: The Beliefs and Intentions of Teacher Educators**

Richie Roberts, *North Carolina A&T State University*  
M. Craig Edwards, *Oklahoma State University*  
J. Shane Robinson, *Oklahoma State University*

## **Abstract**

Service-learning (SL) appears to have influenced school-based, agricultural education (SBAE) since its early inception. And current trends suggest the method may be gaining increased interest in the discipline. However, little is known about the role that agricultural education teacher educators' beliefs and intentions play in deterring SL's use as a method of instruction in the preparation of agricultural education teachers. Therefore, this study's purpose was to understand teacher educators' normative and control beliefs as well as their intentions regarding SL as a method of instruction. Participants reported that barriers existed at the classroom level, which influenced their intentions. SL teaching experience was also found to have a negative and statistically significant ( $p < .01$ ) relationship with agricultural education teacher educators' beliefs about challenges they associated with using the method. As a result, it is recommended that future research explore diffusion methods that could help cultivate more widespread adoption of SL for agricultural education teaching methods courses in the United States.

## **Introduction**

Our world is growing and evolving in complex ways. These changes have necessitated reconsidering how we conceptualize the nature of knowledge, knowing, and teaching (Brownlee, Schraw, & Berthelsen, 2011). As a consequence, scholars (Barnes, 2016; Butcher et al., 2003) have called for teacher preparation programs to prepare graduates to work in *more diverse, challenging, and resource-poor settings*. In response, teacher education programs have begun to place increasing emphasis on introducing preservice teachers to instructional methods intended to facilitate higher-order thinking skills, collaborative learning, as well as the ability to address ambiguous and complex social problems (Yang, Chang, & Hsu, 2008). Because service-learning (SL) as a method of instruction is positioned to assist in achieving such outcomes, it has received growing attention in universities, including teacher preparation programs (Barnes, 2016; Ball & Geleta, 2012; Butcher et al., 2003; Chambers & Lavery, 2012; Hart & King, 2007; Swick, 1999, 2001). SL has been defined operationally as an educational approach by which students learn through providing service in their communities while connecting curricular concepts to real-world issues with embedded opportunities for reflection (Bringle & Hatcher, 1995).

In agricultural education, SL appears to have influenced the discipline since its inception (Roberts & Edwards, 2015, 2017). And current trends suggest the method may be gaining increased interest among teachers and other stakeholders of school-based, agricultural education (SBAE). For instance, recent initiatives promoted by the National FFA Organization, such as the Agricultural SL Supervised Agricultural Experience (SAE) and National FFA Days of Service initiative, may demonstrate a pivot occurring in the discipline with this method of instruction is becoming increasingly used and celebrated (National FFA Organization, 2014; Roberts, Terry,

Brown, & Ramsey, 2016). To this point, Roberts and Edwards (2015) called for agricultural education teacher educators to begin to place emphasis on showcasing SL as a method of instruction. However, doing such remains entangled in a web of social, cultural, and historical forces that complicate the method's acceptance and future possibilities as a substantial and respected instructional tool for SBAE (Roberts & Edwards, 2017). For example, although the aims of SL appear noble in *form* and *function*, Ward (1998) noted that gaining faculty members', including teacher educators, commitments to embrace *engagement* in their local communities remains a critical barrier, especially in regard to implementing SL as a method of instruction. As a result, much of the SL research focuses on the particular factors that either motivated or deterred faculty members from using the method.

The literature demonstrates that perspectives and orientations of academic institutions can negatively influence faculty members' adoption of SL (Moore & Ward, 2010). For example, the type of institution – *teaching* or *research* – can affect decisions to incorporate the method when designing courses (Aldersley, 1995; Pollack, 1999). At institutions emphasizing *research*, expectations for high scholarly productivity along with prioritizing traditional scientific discovery often discourages community engagement (Moore & Ward, 2010). In comparison, faculty members working at institutions stressing *teaching* often have more freedom to engage in instructional methods allowing them to facilitate students' learning experiences in their surrounding communities (Aldersley, 1995). Faculty members at higher education institutions also often have distinctive professional characteristics – including educational backgrounds, training, appointments, and rank – that have been shown to shape their beliefs and intentions regarding SL as a method of instruction (Abes, Jackson, & Jones, 2002; Banerjee & Hausafus, 2007; Colbeck & Wharton-Michael, 2006; Ward, 2003). Moreover, Abes et al. (2002) reported that faculty members at research-focused institutions often articulated they found it difficult to balance their professional roles with using time-consuming instructional methods. And because service is often the least rewarded aspect of the tenure process, many faculty members viewed SL as a *distraction* (Jaeger & Thornton, 2006; Russell-Stamp, 2015; Ward, 2003). Other characteristics may also inhibit faculty members' intentions regarding SL. To this point, Kezar (2013) identified faculty members' skepticism about the method's effectiveness, an absence of related resources and support, insufficient time, and late hiring as barriers to faculty members' intentions to implement SL. Therefore, more intimately understanding how teacher educators' beliefs shape their decisions to use SL in a variety of contexts is a crucial need. Although the existing SL literature provides some insight about deterrents to SL's use in higher education, scant evidence exists regarding the *beliefs* and *intentions* that most profoundly influence how SL is conceptualized and practiced by teacher educators who prepare agricultural education teachers. This deficit in the knowledge base motivated the current study.

### **Theoretical Lens**

In this investigation, we chose to study *human behavior* through the prism of the theory of planned behavior (TPB). TPB, as articulated by its chief architect, Icek Ajzen (1991), posits that an individual's engagement in a particular behavior is a product of his or her underlying *beliefs* and *intentions* toward such action. In the TPB, individuals' views are guided by three underlying belief systems: (a) behavioral (attitudes), (b) normative (subjective or social norms), and (c) control (perceived behavior controls). *Behavioral beliefs* are views that an individual may hold



about the consequences, positive or negative, of exercising a behavior. As such, behavioral beliefs have been shown to greatly influence the development of attitudes about particular endeavors (Ajzen, 2006). *Normative beliefs* refer to the amount of social pressure an individual perceives regarding a behavior (Ajzen, 2002). The final belief system, *control beliefs*, are linked to the amount of difficulty perceived to be associated with executing a behavior. Another antecedent of actualized behaviors are individuals' intentions; by altering intentions, behaviors also can be modified (Ajzen, 2006).

Smith (2008) found faculty members' SL beliefs were related to their perceived abilities to navigate the challenges of implementing the method. Studies have also demonstrated statistically significant relationships between *normative* and *control* beliefs and faculty members' SL intentions, especially in regard to the method's deterrents (Abes et al., 2002; Bagnardi, 2006). In this investigation, behavioral beliefs were operationalized as agricultural education teacher educators' perceived beliefs about SL's benefits to communities and secondary school classrooms. Normative beliefs were interpreted as the barriers study participants may have perceived at the institutional level. Meanwhile, we analyzed participants' control beliefs as their perceived *barriers at the university classroom level*. Finally, intentions were measured by analyzing teacher educators' course syllabi. It should be noted that the literature (Abes et al., 2002; Banerjee & Hausafus, 2007; Frolow, 2010; Hou, 2010) identifies several key *external variables* that also may influence the behaviors of university faculty in regard to SL. Therefore, the influence of the most consistently reported extraneous variables were also explored in this study. External variables included (a) experience, (b) gender, (c) age, (d) education, (e) tenure/rank, and (f) institution type. Application of the TPB in the study is displayed in Figure 1.

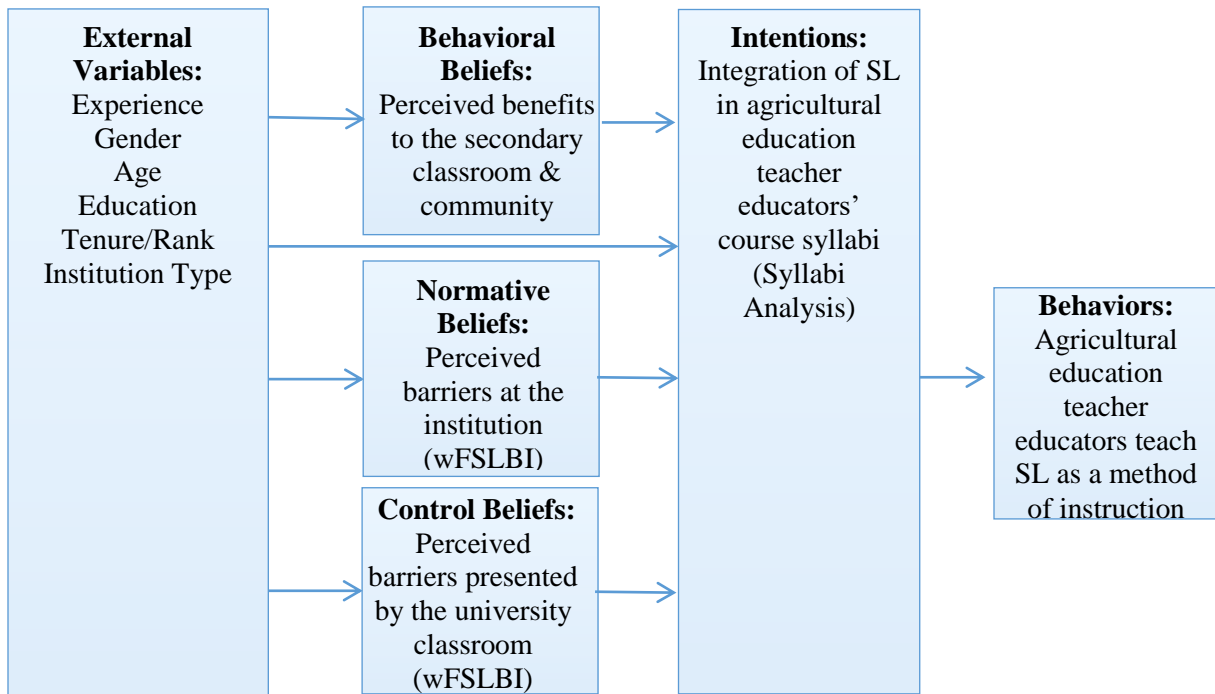

Figure 1. Application of the theory of planned behavior (Ajzen, 1991), as contextualized to agricultural education teacher education.

## Purpose

The study's purpose was to understand agricultural education teacher educators' *normative* and *control* beliefs as well as their *intentions* regarding SL as a method of instruction. Data reported were derived from a larger investigation; participants' *behavioral beliefs* were examined but are not portrayed here. Because emphasis was placed on understanding factors that deter SL's use in the preparation of agricultural education teachers, this study addresses the American Association for Agricultural Education's Research Priority Area 6: *Vibrant, Resilient Communities*. This priority calls for investigations into educational methods that can be used to help communities build the capacity needed to "deal with community problems without relying on external resources" (Graham, Arnold, & Jayaratne, 2016, p. 51). To fulfill the study's purpose, three objectives guided the investigation: 1. Describe the *normative* and *control* beliefs of agricultural education teacher educators regarding SL; 2. Describe the *intentions* of agricultural education teacher educators regarding SL; and 3. Describe the relationships that existed among agricultural education teacher educators' *normative* and *control* beliefs, *intentions*, and *external variables* regarding SL.

## Methods and Procedures

In this study, data were collected through the Qualtrics™ online survey system and in accord with Dillman's, Smyth's, and Christian's (2014) tailored design method's procedures. To begin the data collection process, a pre-notice message was sent as an electronic mail message to the AAAE listserv inviting members to participate in the study. This message included a brief description of the study. Three days later, we distributed an electronic mail message invitation to AAAE members. The invitation message included three components: (a) description of the study, (b) questions regarding participants' characteristics, and (c) a link to the instrument. After two weeks, a follow-up notice was sent to potential respondents as an electronic mail message. The second reminder notice was sent 10 days later. The final notice was sent one week thereafter. After participants completed the online survey instrument, they were asked to upload a course syllabus for one of their teaching methods courses to a Qualtrics™ digital dropbox or to send the document to the researcher as an electronic mail attachment. The 46 participants who completed the survey instrument and submitted their course syllabi qualified for one of the study's incentives, two \$50 gift cards.

## Description of the Study's Population and Recruitment Procedures

The population for this study was a census of agricultural education teacher educators who were active members of AAAE and taught at least one teaching methods course to preservice agricultural education students in the past three years or would during the spring academic term of 2017. The respondent frame for this study was supplied by AAAE's listserv and corroborated by the organization's membership directory as maintained by its membership secretary (AAAE, 2016). Participants were required to self-identify as agricultural education teacher educators before responding; however, it is possible that individuals who matched the population parameters did not receive an invitation to participate, especially if they were not members of AAAE at the time of the study. Therefore, those individuals would not have had the opportunity to provide responses, i.e., coverage error may have occurred (Dillman, et al., 2014). As a result

of the study's recruitment procedures, 77 individuals responded. However, 31 did not meet the study's a priori requirements: (a) completion of the instrument, (b) submission of a course syllabus from a teaching methods course, and (c) providing contact information for follow-up procedures. As such, it was determined that 46 individuals (59%) provided usable responses.

The population was comprised of 33 males and 13 females. Forty-five (97.8%) participants reported they were White and one (2.2%) participant indicated she was African American. Despite exhibiting similarity regarding gender and race/ethnicity, participants were more diverse in age; 17 (36.9%) were from 31 to 40 years of age and 13 (28.3%) were from 41 to 50 years of age. In all, 26 states were represented in this study. More participants were from Texas ( $f = 7$ ; 15.2%) than other states; however, Kentucky, North Carolina, Oklahoma, and Tennessee each had three (6.5%) representatives. More than 97% ( $f = 45$ ) of the participants held doctoral degrees. In addition, 22 (47.8%) were assistant professors and 20 (43.5%) were either associate professors or professors. Twenty-two (47.8%) participants were tenured, 18 (39.1%) were on a tenure track, and five (10.9%) were not on a tenure track. To understand better the educators' institutional characteristics, they were asked to provide information concerning their universities' land-grant institution and Carnegie Classifications for Higher Education statuses. In response, 67.4% ( $f = 31$ ) indicated they were employed at a land-grant institution and 32.6% ( $f = 15$ ) not. And more than 58% ( $f = 27$ ) worked at a Research 1 Institution. The agricultural education teacher educators were also asked to reveal their SL experiences. Twenty-six (56.5%) participants indicated they had teaching experiences involving SL. However, two-thirds (67.4%) did not experience SL as a student in postsecondary education and 76.1% had not at the secondary level.

## **Instrumentation**

The study's web-based instrument consisted and items slightly modified from Hou's (2010) Web-based Faculty Service-Learning Beliefs Inventory (wFSLBI) and questions about the educators' personal and professional characteristics. Participants also submitted course syllabi on Qualtrics™, or by electronic mail, that were evaluated by three independent raters using a slightly modified version of *Service-Learning Syllabus Analysis Guide* [SLSAG] (Gelmon, Holland, Driscoll, Spring, & Kerrigan, 2001). The wFSLBI was designed to understand faculty members' SL beliefs and is theoretically grounded in Ajzen's (1991) TPB. Hou's (2010) instrument contains four distinct subscales: (1) perceived benefits at the classroom level (PROS\_CLS) with seven items, (2) perceived benefits at the community level (PROS\_COM) with seven items, (3) perceived barriers at the institutional level (CONS\_INST) with three items, and (4) perceived barriers at the classroom level (CONS\_CLS) with four items. In this study, however, only findings from CONS\_CLS and CONS\_INST are featured.

The wFSLBI was presented on a five-point, Likert-type scale using these anchors to measure agreement: *1 = Strongly agree*, *2 = Agree*, *3 = Neutral*, *4 = Disagree*, and *5 = Strongly disagree* (Hou, 2010). During the instrument validation phase, Hou (2010) administered the wFSLBI to 449 tenured and tenure-track faculty members at a U.S. research university. Because of the importance of SL teaching experience, Hou (2010) conducted validation measures on each of the four subscales regarding this variable. As a result, Hou (2010) reported the instrument demonstrated satisfactory reliability estimates on all items with Cronbach's alphas ranging from

.65 to .85 for participants with SL teaching experience and from .74 to .91 for those individuals without. Posthoc reliability estimates in the current study were .71 or larger and considered acceptable (Field, 2013).

The second instrument employed in this investigation was the SLSAG (Gelmon et al., 2001), which was used to analyze the agricultural education teacher educators' *intentions* in regard to using SL as a method of instruction. Gelmon et al. (2001) designed the SLSAG as a way to assess whether faculty members had intentions to incorporate quality indicators of SL into their courses. For the purpose of this investigation, we slightly modified the SLSAG to more appropriately fit the agricultural education teacher education context. To improve the reliability of this analysis, two external raters and the lead researcher scored participants' syllabi (Bornmann, Mutz, & Daniel, 2010). Before the rating process began, we provided a training session for the raters in which proper use of the SLSAG to score the syllabi was explained. Thereafter, each rater scored a randomly selected syllabus to identify scoring differences so recommendations could be provided to improve consistency among the raters. Raters individually assigned a "1" to items on the instrument if the syllabus contained the SL element and a "0" if it did not. Interrater reliability of the SLSAG was assessed using intraclass correlation coefficients (ICCs), which is the most widely accepted measure for interrater reliability (Shrout & Fleiss, 1979). In this study, interrater reliability analysis yielded an ICC of .88, which was considered satisfactory (Whitehurst, 1984).

In addition to the wFSLBI and SLSAG, we also obtained the participants' personal and professional characteristics. These items were mostly dichotomous or categorical; for example, we inquired about participants' SL teaching experiences, experiences with SL at the postsecondary and secondary levels, ages, genders, home states, tenure statuses, institution types, whether their institutions were land-grant universities, and the ranking of their universities on the Carnegie Classification of Higher Institution's scale.

## Data Analysis

To address objective one and two, descriptive statistics were performed to report measures of central tendency, including frequencies, means, and standard deviations (Gay, Mills, & Airasian, 2012). For objective three, bivariate correlational analysis was conducted to describe relationships between participants' beliefs and intentions in regard to using SL as a method of instruction based on Gay et al. (2012) recommendations. Depending on the variables tested – dichotomous, categorical, or ordinal – bivariate correlational analyses were computed, including point bi-serial correlational coefficient and Spearman's Rho. Davis' conventions (as cited in Miller, 1994) were used to describe the magnitudes of the correlation coefficients.  $0.1 \geq r \geq .09 = \textit{Negligible}$ ;  $.10 \geq r \geq .29 = \textit{Low}$ ;  $.30 \geq r \geq .49 = \textit{Moderate}$ ;  $.50 \geq r \geq .69 = \textit{Substantial}$ ; and  $.70 \geq r \geq .99 = \textit{Very High}$ .

## Findings

### Objective One

To operationalize normative and control beliefs, Hou's (2010) wFSLBI was employed. The instrument used a Likert-type scale with anchors ranging from 1 = *Strongly agree* to 5 =

*Strongly disagree*. As such, the real limits were 1.00 to 1.49 = *Strongly agree*, 1.50 to 2.49 = *Agree*, 2.50 to 3.49 = *Neutral*, 3.50 to 4.49 = *Disagree*, and 4.50 to 5.00 = *Strongly disagree*. Responding to the CONS\_INST items, the subscale score yielded a *neutral perspective* ( $M = 2.92$ ;  $SD = .953$ ) regarding participants' beliefs about institutional barriers to using SL as a method of instruction. Item response percentages for the CONS\_INST subscale, used to measure participants' normative beliefs (Ajzen, 1991), are provided in Table 1.

Table 1

<i>Item Response Percentages for the CONS_INST subscale on the wFSLBI</i>					
Item	1	2	3	4	5
Faculty promotion and tenure policies do not support or encourage my use of service-learning as a method of instruction	10.9	28.3	26.1	21.7	13.0
Administrative leaders actively work to make service-learning a visible and important part of institutional work	15.2	26.1	28.3	23.9	6.5
My colleagues understand and value service-learning in promotion, tenure, and annual evaluation decisions	10.9	23.9	28.3	30.4	6.5

*Note.* 1 = *Strongly agree*; 2 = *Agree*; 3 = *Neutral*; 4 = *Disagree*; and 5 = *Strongly disagree*

For the CONS\_CLS subscale, participants indicated they *agreed* ( $M = 2.28$ ;  $SD = .682$ ) that barriers existed at the classroom level in regard to integrating SL as a method of instruction. Table 2 provides item response percentages for the CONS\_CLS subscale, which was used to measure agricultural education teacher educators' control beliefs (Ajzen, 1991).

Table 2

<i>Item Response Percentages for the CONS_CLS subscale on the wFSLBI</i>					
Item	1	2	3	4	5
Time constraints interfere with my ability to teach a service-learning course	19.6	47.8	30.4	2.2	0.0
I feel that I am giving up control of the learning experience when teaching a service-learning course	19.6	60.9	13.0	4.3	2.2
I have a harder time assessing student learning and work in a service-learning course than in a traditional course	21.7	30.4	34.8	10.9	2.2
I experience challenges with the reduced time for classroom instruction in my	17.4	43.5	19.6	17.4	2.2

*Item Response Percentages for the CONS\_CLS subscale on the wFSLBI*

Item	1	2	3	4	5
service-learning course					

*Note.* 1 = *Strongly agree*; 2 = *Agree*; 3 = *Neutral*; 4 = *Disagree*; and 5 = *Strongly disagree*

## Objective Two

The second objective sought to assess participants’ intentions in regard to using SL as a method of instruction. To accomplish this, Gelmon et al. (2001) SLSAG was used. The distribution of raters’ composite item selections were expressed through means and standard deviations. When scoring syllabi, raters assigned a score of “0” if a syllabus did not contain a particular SL element and “1” was assigned if the element was present (Gelmon et al., 2001). Then, to calculate the distribution of raters’ item selections for the SLSAG, item frequencies were summed across raters and averaged by the total number of raters. Thereafter, item frequency was reported through composite means and standard deviations to allow direct comparison of SLSAG items in regard to raters’ selection frequency. “Time dedicated to outlining the *use* of service-learning as an instructional method” emerged as the most frequently identified item ( $M = 4.00$ ;  $SD = .266$ ) in the agricultural education teacher educators’ syllabi, as determined by the study’s raters. The raters also identified “time dedicated to outlining partner-building techniques that might be employed when using service-learning as an instructional method” ( $M = 3.00$ ;  $SD = .206$ ) and “time dedicated to describing the *philosophy* of service-learning as an instructional method” ( $M = 2.67$ ;  $SD = .225$ ) more frequently than other items. Two of the 10 scoring criteria – “course objectives that are directly related to the teaching and learning of service-learning as an instructional method” and “course objectives that identify teaching the *philosophy* of service-learning as an instructional method” – were not found in any of 46 course syllabi (see Table 3).

Table 3

*Composite Means of Raters’ Frequencies for the SLSAG Items: Agricultural Education Teacher Educators’ Course Syllabi*

Service-Learning Course Elements	Composite Mean	SD
Time dedicated to outlining the <i>use</i> of service-learning as an instructional method.	4.00	.266
Time dedicated to outlining partner-building techniques that might be employed when using service-learning as an instructional method.	3.00	.206
Time dedicated to describing the <i>philosophy</i> of service-learning as an instructional method.	2.67	.225
Course objectives that directly relate to teaching the <i>use</i> of service-learning as an instructional method.	2.33	.201

Service-Learning Course Elements	Composite Mean	SD
Time dedicated to outlining techniques that might be used to <i>evaluate student learning</i> when using service-learning as an instructional method.	2.00	.150
Time dedicated to outlining <i>reflection techniques</i> that might be used to complement service-learning as an instructional method.	1.00	.083
The course description identifies service-learning as a topic to be addressed.	1.00	.108
Targeted readings/guest speakers/out-of-class assignments designed to augment learning regarding service-learning as an instructional method.	0.33	.049
Course objectives that are directly related to the teaching and learning of service-learning as an instructional method.	0.00	0.00
Course objectives that identify teaching the <i>philosophy</i> of service-learning as an instructional method.	0.00	0.00

To evaluate participants' intentions regarding their use of SL as a method of instruction, items on the SLSAG were summed and averaged across raters. Thereafter, individual mean scores were assessed using the following standards: 0 = *Nonexistent*; 1 to 2 = *Poor*; 3 to 5 = *Fair*; 6 to 7 = *Strong*; 7 to 9 = *Excellent*; and 10 = *Outstanding*. In total, one participant received a rating of *fair*, 18 *poor*, and 27 did not have any SL elements incorporated into their syllabi, as specified by the SLSAG and expressed by averaging the three raters' scores. As such, the participants' overall mean intentions score was 0.70 ( $SD = .846$ ) suggesting that agricultural education teacher educators' intentions to integrate SL into their methods courses were mostly *nonexistent*.

### Objective Three

The third objective sought to examine the relationships between participants' beliefs, intentions, and selected external variables. As such, this section is organized by the appropriate bivariate correlational analysis (Field, 2013) used to describe the associations: (a) Spearman's Rho and (b) point-biserial. Each relationship was interpreted using conventions outlined by Davis (as cited in Miller, 1994) to describe magnitudes of association. Relationships were examined regarding agricultural education teacher educators' beliefs and intentions about SL as a method of instruction. A moderate and positive relationship ( $r_s = .376$ ;  $p < .01$ ) was found between CONS\_CLS and Intentions, suggesting that participants' future behaviors were influenced by their views of existing barriers to using SL at the classroom level. No other statistically significant relationships were revealed among the variables examined (see Table 4).

Table 4

*Spearman's Rho Correlation Matrix for Agricultural Education Teacher Educators' SL Beliefs and Intentions*

Variables	1	2	3
1. CONS_CLS	-		
2. CONS_INST	.164	-	
3. Intentions	.376**	.236	-

Note. \*\*Significant correlation coefficient at the 0.01 level.

Other relationships between the dependent variables measuring agricultural education teacher educators' beliefs and perceptions of barriers regarding their use of SL as a method of instruction and selected characteristics were described using Spearman's Rho correlation coefficient. No other statistically significant relationships were identified.

Point-biserial correlational analysis between dependent variables measuring the agricultural education teacher educators' beliefs and perceptions of barriers regarding the use of SL as a method of instruction and their selected personal and professional characteristics revealed two statistically significant relationships at  $p < .01$ . In particular, SL teaching experience demonstrated a very high and negative relationship with Intentions ( $r_{pb} = -.736$ ), and a moderate and negative relationship with CONS\_CLS ( $r_{pb} = -.483$ ). The other relationships tested between the variables were not statistically significant (see Table 5).

Table 5

*Point-biserial Correlations for Dependent Variables Measuring the Agricultural Education Teacher Educators' Beliefs and Perceptions of Barriers Regarding SL as a Method of Instruction and their selected Personal and Professional Characteristics*

Dependent Variables	Gender	SL Teaching Experience	SL Postsecondary Experience	SL Secondary Experience	Land-grant Institution Employment
CONS_CLS	.136	-.483**	-.243	.093	.254
CONS_INST	-.051	-.286	-.044	.097	-.118
Intentions	.253	-.736**	-.185	-.282	-.098

Note. \*\*Significant correlation at the 0.01 level.

### Conclusions and Implications

This study aimed to understand agricultural education teacher educators' *normative* and *control* beliefs as well as their *intentions* regarding SL as a method of instruction. The study's results indicated that participants held a *neutral perspective* about existing barriers to SL at the institutional level, i.e. their normative beliefs (Ajzen, 1991). However, they generally *agreed* that



control beliefs (Ajzen, 1991), or barriers to the classroom, served as a deterrent to SL's use in the preparation of agricultural education teachers. These findings are consistent with the existing SL literature in regard to faculty members' beliefs (Banerjee & Hausafus, 2007; Jaeger & Thornton, 2006; Ward, 2003). However, such findings have not been reported in agricultural education. Through the analysis of participants' course syllabi, it was determined that the intentions of agricultural education teacher educators regarding the use of SL as a method of instruction were mostly *nonexistent*. Although this finding is not present in the existing agricultural education literature, when considering the issue more broadly, other research indicates several critical reasons why university faculty members resist pedagogical innovations such as SL. For example, Koslowski (2006) argued faculty rejected educational innovations because they did not understand the related aims and purposes, perceived their academic freedom was being abridged, or held the position that they were too overwhelmed with other responsibilities to adopt a new practice.

A moderate and positive relationship was found between participants' conceptions of existing classroom challenges associated with SL and their intentions to implement the method. In a path analysis study, Bagnardi (2006) noted that control beliefs (challenges) exhibited a strong path to the intentions of faculty members regarding their use of SL as a method of instruction. Therefore, this study's finding is consistent with Bagnardi's (2006) results but adds a new dimension to agricultural education's literature base. A very high and negative relationship was also found in regard to agricultural education teacher educators' prior SL teaching experiences and intentions to use SL to instruct preservice students of agricultural education – a view currently not reflected in the literature. Prior SL teaching experience also yielded a moderate and negative relationship with participants' beliefs that barriers to implementing SL existed at the classroom level. The view that previous SL experience influences the beliefs of university faculty members is well situated in existing literature (Abes et al., 2002; Hou, 2010; Russell-Stamp, 2015). However, this finding provides new insight regarding the role that SL teaching experience may play in shaping how agricultural education teacher educators view the challenges inherent to using the method.

### **Recommendations**

Findings from this study provide important opportunities for future research and practice. For example, we recommend that future research explore the diffusion methods and techniques (Rogers, 2003) that could help stimulate more widespread adoption of SL for teaching methods courses in agricultural education in the United States. Results from this study also call attention to the need for more understanding regarding which opinion leaders (Rogers, 2003) in the social networks of agricultural education teacher educators most profoundly influence their decisions about curricular choices for teaching methods courses intended to prepare SBAE instructors. Perhaps a better understanding of the influence of these communication channels could provide implications for addressing the perceptions, attitudes, and beliefs about methods that best prepare future agricultural education teachers.

Because of the importance of the role of SL teaching experience, professional development models also should be explored to determine which would best prepare agricultural education teacher educators to use SL as a method of instruction with their preservice students. Due to the lack of intentions to integrate SL as a method of instruction, as evinced by the participants'

course syllabi, more work is also needed to understand how agricultural education teacher educators prioritize and select the various teaching methods used in their teacher preparation programs. Further, more understanding is needed about why SL is largely excluded from being allocated instructional time, as expressed by the teacher educators' intentions.

### Discussion

Across academic disciplines, university faculty members have been called to turn their attention to community-based learning and renewal efforts to create mutual respect while also balancing relations of power (Hoy & Johnson, 2013). As community revitalization efforts and SL continue to intersect, Butin (2006) theorized these linkages could create a new movement in higher education institutions by which *communities* and *schools* become transformed in positive and generative ways. However, Roncolato (2013) argued the integration of SL and community renewal efforts do not usually occur in bounded contexts. Instead, advocates often emerge individually to create a formidable base to diffuse the concept more broadly (Jacoby, 2009). For example, it was the early proponents of SL who developed programming, drafted policies, created awards, and provided additional support to encourage its institutionalization (Stanton et al., 1999). These efforts, however, remain somewhat formative and are still taking shape in teacher education programs (Chambers & Lavery, 2012). Nevertheless, proponents of the method in teacher education (Barnes, 2016; Hildenbrand & Schultz, 2015; Tatebe, 2013) have recently called for SL to be a central focus of teacher preparation and credentialing.

At some teacher credentialing institutions, this call has been answered by implementing expectations for growth in preservice students' *leadership* and *service* as core components of their professional development and to better align such with standards established by the Council for the Accreditation of Educator Preparation (C.A.E.P, 2017). As a working example, Oklahoma State University's teacher educators include a *service orientation* and *community outreach* expectation in their professional education units by which preservice students must demonstrate a commitment to service before entering the classroom (Oklahoma State University, 2017). The students must also provide evidence of service experiences as well as articulate the ways they intend to weave service-based endeavors into their future careers as educators (Oklahoma State University, 2017).

In addition, results from this study provided insights into beliefs and intentions that deter SL's use in teacher preparation programs of agricultural education. And, as a result, suggests implications for exploring how the *silencing of SL in teacher preparation* may limit students' learning experiences as well as the welfare of their communities. Perhaps these trends in teacher education present opportunities for *opening up* new possibilities by which to implement SL in teacher education, i.e., using the method to facilitate service-based outcomes while also integrating related curricular aims. This implication appears to be especially important in light of Roberts' and Edwards' (2015) proposition that instructors could use the method in each component of SBAE's comprehensive, three-circle model to enhance students' learning experiences. Although Roberts and Edwards (2015) illuminated new possibilities for the method in the context of agricultural education, at least two questions remain: *How could we best prepare preservice students to integrate the major components of SBAE's three-circle model by using SL as a method of instruction?* and *Is this an appropriate aim worthy of garnering the attention of teacher educators, teachers, and other stakeholders in agricultural education?* As

such, more contemplation by and action from researchers and practitioners of agricultural education is needed in regard to SL as a method of instruction for enhancing the aims of SBAE.

## References

- Abes, E. S., Jackson, G., & Jones, S. R. (2002). Factors that motivate and deter faculty use of service-learning. *Michigan Journal of Community Service Learning*, 9(1), 5-17. Retrieved from <http://hdl.handle.net/2027/spo.3239521.0009.101>
- Ajzen, I. (1991). The theory of planned behavior. *Organizational Behavior and Human Decisions Processes*, 50(1), 179-211. doi:10.1016/0749-5978(91)90020-T
- Ajzen, I. (2002). *Constructing a TpB questionnaire: Conceptual and methodological considerations*. Amherst: University of Massachusetts System. Retrieved from <http://www.people.umass.edu/aizen/pdf/TpB.measurement.pdf>
- Ajzen, I. (2006). *Behavioral interventions based on the theory of planned behavior*. Amherst: University of Massachusetts System. Retrieved from <http://www.people.umass.edu/aizen/pdf/tpb.intervention.pdf>
- Aldersley, S. F. (1995). Upward drift is alive and well: Research/doctoral model still attractive to institutions. *Change*, 27(5), 50-56. doi:10.1080/00091383.1995.9936448
- American Association for Agricultural Education. (2016). *Membership information*. Author. Retrieved from <http://www.aaaeonline.org/join>
- Bagnardi, M. (2006). *Faculty intention to use service learning as pedagogy in higher education* (Doctoral dissertation). Available from ProQuest Dissertations and Theses Database. (UMI No. 3217559)
- Ball, D., & Geleta, N. (2012). A delicate balance: Service-learning in teacher education. *Journal of the Scholarship of Teaching and Learning*, 5(1), 1-17. Retrieved from <http://files.eric.ed.gov/fulltext/EJ910337.pdf>
- Banerjee, M., & Hausafus, C.O. (2007). Faculty use of service-learning: Perceptions, motivations, and impediments for the human sciences. *Michigan Journal of Community Service Learning*, 14(1), 32-45. Retrieved from <http://hdl.handle.net/2027/spo.3239521.0014.103>
- Barnes, M. E. (2016). The student as teacher educator in service-learning. *Journal of Experiential Education*, 39(4), 238-253. doi:10.1177/1053825916643831
- Bornmann, L., Mutz, R., & Daniel, H. D. (2010). A reliability-generalization study of journal peer reviews: A multilevel meta-analysis of inter-rater reliability and its determinants. *PLoS ONE*, 5(12), 1-10. doi:10.1371/journal.pone.0014331

- Bringle, R. G., & Hatcher, J. A. (1995). A service-learning curriculum for faculty. *Michigan Journal of Community Service Learning*, 2(1), 112-122. Retrieved from <http://hdl.handle.net/2027/spo.3239521.0002.111>
- Brownlee, J., Schraw, G., & Berthelsen, D. (2011). *Personal epistemology and teacher education*. New York, NY: Routledge.
- Butcher, J., Howard, P., Labone, E., Bailey, M., Groundwater, S., McFadden, . . . & Martinez, K. (2003). Teacher education, community service learning, and student efficacy for community engagement. *Asia-Pacific Journal of Teacher Education*, 31(1), 109-124. doi:10.1080/13598660301612
- Butin, D. W. (2006). The limits of service-learning in higher education. *The Review of Higher Education*, 29(4), 473-498. doi:10.1353/rhe.2006.0025
- Chambers, D. J., & Lavery, S. (2012). Service-learning: A valuable component of pre-service teacher education. *Australian Journal of Teacher Education*, 37(4), 99-108. Retrieved from <http://search.informit.com.au/documentSummary;dn=767781396834335;res=IELAPA>
- Colbeck, C. L., & Wharton-Michael, P. (2006). Individual and organizational influences on faculty members' engagement in public scholarship. *New Directions for Teaching and Learning*, 2006(105), 17-26. doi:10.1002/tl.220
- Council for the Accreditation of Educator Preparation [CAEP]. (2017). *Accreditation and program review*. Washington, DC: Author. Retrieved from <http://www.caepnet.org/accreditation/about-accreditation/what-is-accreditation>
- Dillman, D. A., Smyth, J. D., & Christian, L. M. (2014). *Internet, phone, mail, and mixed-mode surveys: The tailored design method* (4th ed.). Hoboken, NJ: John Wiley & Sons.
- Field, A. (2013). *Discovering statistics using IBM SPSS statistics* (4th ed.). Thousand Oaks, CA: Sage.
- Frolow, M. (2010). *Determinants of a professor's decision to include service-learning in an academic course* (Unpublished doctoral dissertation). Seton Hall University, South Orange, NJ: Retrieved from <http://scholarship.shu.edu/cgi/viewcontent.cgi?article=1366&context=dissertations>
- Gay, L. R., Mills, G. E., & Airasian, P. W. (2012). *Educational research: Competencies for analysis and applications* (10th ed.). Boston, MA: Pearson.
- Gelmon, S. B., Holland, B. A., Driscoll, A., Spring, A., & Kerrigan, S. (2001). *Assessing service learning and civic engagement: Principles and techniques*. Providence, RI: Campus Compact.

- Graham, D. L., Arnold, S., & Jayaratne, K. S. U. (2016). Research priority 6: Vibrant, resilient communities. In T. G. Roberts, A. Harder, & M. T. Brashears (Eds.), *American Association for Agricultural Education national research agenda: 2016-2020* (pp. 49-56). Gainesville: Department of Agricultural Education and Communication, University of Florida.
- Hart, S. M., & King, J. R. (2007). Service learning and literacy tutoring: Academic impact on pre-service teachers. *Teaching and Teacher Education*, 23(4), 323-338. doi:10.1016/j.tate.2006.12.004
- Hildenbrand, S. M., & Schultz, S. M. (2015). Implementing service learning in pre-service teacher coursework. *Journal of Experiential Education*, 38(3), 262-279. doi:10.1177/1053825915571748
- Hou, S. I. (2010). Developing a faculty inventory measuring perceived service-learning benefits and barriers. *Michigan Journal of Community Service Learning*, 16(2), 78-89. Retrieved from <http://hdl.handle.net/2027/spo.3239521.0016.206>
- Hoy, A., & Johnson, M. (2013). *Deepening community engagement in higher education: Forging new pathways*. New York, NY: Palgrave MacMillan.
- Jacoby, B. (2009). *Civic engagement in higher education: Concepts and practices*. San Francisco, CA: Jossey-Bass.
- Jaeger, A. J., & Thornton, C. H. (2006). Neither honor nor compensation: Faculty and public service. *Educational Policy*, 20(2), 345-366. doi:10.1177/0895904805284050
- Kezar, A. (2013). Departmental cultures and non-tenure track faculty: Willingness, capacity, and opportunity to perform at four-year institutions. *Journal of Higher Education*, 84(2), 153-183. doi:10.1353/jhe.2013.0011
- Koslowski, F. (2006). *Overcoming faculty resistance to assessment*. Raleigh: North Carolina State University Press. Retrieved from [www.ncsu.edu/assessment/symposium/presentations/A.10\\_Koslowski.pdf](http://www.ncsu.edu/assessment/symposium/presentations/A.10_Koslowski.pdf)
- Moore, T. L., & Ward, K. (2010). Institutionalizing faculty engagement through research, teaching, and service at research universities. *Michigan Journal of Community Service Learning*, 17(1), 44-58. Retrieved from <http://hdl.handle.net/2027/spo.3239521.0017.104>
- Miller, L. E. (1994). Correlations: Description or inference? *Journal of Agricultural Education*, 35(1), 5-7. doi:10.5032/jae.1994.01005
- National FFA Organization. (2014). *Supervised agricultural experience handbook*. Indianapolis, IN: Author. Retrieved from [https://www.ffa.org/documents/learn/sae\\_handbook\\_V12.pdf](https://www.ffa.org/documents/learn/sae_handbook_V12.pdf)

- Oklahoma State University. (2017). [State] University LEADS core values. Stillwater, OK: Author. Retrieved from <https://education.oklahoma.edu/peu/leads>
- Pollack, S. (1999). Early connections between service and education. In T. K Stanton, D. E. Giles, & N. I. Cruz (Eds.) *Service-learning: A movement's pioneers reflect on its origins, practice, and future* (pp. 12-32). San Francisco, CA: Jossey-Bass Publishers.
- Roberts, R., & Edwards, M. C. (2015). Service-learning's ongoing journey as a method of instruction: Implications for school-based, agricultural education. *Journal of Agricultural of Agricultural Education*, 56(2), 217-233. doi:10.5032/jae.2015.02217
- Roberts, R., & Edwards, M. C. (2017). *Imaging service-learning in The Agricultural Education Magazine from 1929-2009: Implications for the method's reframing and use*. Paper presented at the meeting of the American Association for Agricultural Education (AAAE) National Conference, San Luis Obispo, CA.
- Roberts, R., Terry R., Jr., Brown, N. R., & Ramsey, J. W. (2016). Students' motivations, value, and decision to participate in service-learning at the National FFA Days of Service. *Journal of Agricultural Education*, 57(2), 187-202. doi:10.5032/jae.2016.02187
- Rogers, E. M. (2003). *Diffusion of innovations* (5th ed.). New York, NY: The Free Press.
- Roncolato, D. (2013). Building deep partnerships and community-centered centers. In A. Hoy & M. Johnson (Eds.), *Deepening community engagement in higher education* (pp. 83-94). New York, NY: Palgrave-Macmillan US.
- Russell-Stamp, M. (2015). Faculty use of community-based learning: What factors really matter? *Michigan Journal of Community Service Learning*, 21(2), 37-48. Retrieved from <http://hdl.handle.net/2027/spo.3239521.0021.203>
- Shrout, P. E., & Fleiss, J. L. (1979). Intraclass correlations: Uses in assessing rater reliability. *Psychological Bulletin*, 86(2), 420-428. doi:10.1037/0033-2909.86.2.420
- Smith, C. P. (2008). *Perceptions, motivations, and concerns of post-secondary faculty regarding implementing service-learning pedagogy into curriculum* (Doctoral dissertation). Available from ProQuest. (UMI No. 3444942)
- Stanton, T. K., Giles, D. E., & Cruz, N. I. (1999). *Service-learning: A movement's pioneers reflect on its origins, practice, and future*. San Francisco, CA: Jossey-Bass.
- Swick, K. J. (1999). Service learning helps future teachers strengthen caring perspectives. *The Clearing House*, 73(1), 29-32. doi:10.1080/00098659909599635
- Swick, K. J. (2001). Service-learning in teacher education: Building learning communities. *The Clearing House*, 74(5), 261-264. doi:10.1080/00098650109599204

- Tatebe, J. (2013). Bridging gaps: Service learning in teacher education. *Pastoral Care in Education, 31*(3), 240-250. doi:10.1080/02643944.2013.774044
- Ward, K. (1998). Addressing academic culture: Service learning, organizations and faculty work. In R. Rhoads & J. Howard (Eds.), *Academic service learning: A pedagogy of action and reflection* (pp. 73-80). San Francisco, CA: Jossey-Bass.
- Ward, K. (2003). Faculty service roles and the scholarship of engagement. *Higher Education Report, 29*(5), 1-188. Retrieved from <http://files.eric.ed.gov/fulltext/ED476222.pdf>
- Whitehurst, G. J. (1984). Interrater agreement for journal manuscript reviews. *American Psychologist, 39*(1), 22-28. doi:10.1037/0003-066X.39.1.22
- Yang, F. Y., Chang, C. Y., & Hsu, Y. S. (2008). Teacher views about constructivist instruction and personal epistemology: A national study in Taiwan. *Educational Studies, 34*(5), 527-542. doi:10.1080/03055690802288486

## **Student Perceptions of Accelerated Course Delivery Format for Teacher Preparation Coursework**

Blake C. Colclasure, University of Florida  
Sarah E. LaRose, University of Florida  
Anna J. Warner, University of Florida  
Taylor K. Ruth, University of Florida  
J. C. Bunch, University of Florida  
Andrew C. Thoron, University of Florida  
T. Grady Roberts, University of Florida

### **Abstract**

Acceleration of courses has been documented to achieve an extended academic calendar, financial benefits to universities, time savings for professors, and provide more flexibility for students. The purpose of this study was to examine preservice teachers' learning experiences while enrolled in two accelerated teacher preparation courses. Based on the results of this study, several conclusions can be drawn. Students were dissatisfied with the accelerated course format. They reported feeling stressed and noted many challenges to meeting course expectations. They did, however, perceive benefits like time management and realistic expectations for teachers. Additionally, students perceived they mastered the concepts from both courses. Although they did not prefer the accelerated course structure, it appears to have been successful in helping students gain the expected knowledge and skills. Based on conclusions of this study, recommendations include (a) courses be reformatted back to the traditional semester delivery, (b) the curriculum design course be moved to the semester prior to the teaching methods course, and (c) universities should carefully review their entire teacher education curricula before adopting an accelerated class format.

### **Introduction and Literature Review**

Teacher education in agriculture aims to prepare the next generation of agriculture teachers working in public schools throughout the country (Wardlow & Osborne, 2010). The goal of teacher education in agriculture has been described as "to prepare teachers who are competent in a variety of agricultural subject matter areas and who are effective in the methods and techniques of curriculum planning, instruction, and student and program evaluation" (Barrick & Garton, 2010, p. 32). To meet this goal, teacher education programs have required students to complete coursework in instructional design, teaching methods, and program planning.

In a review of selected agricultural teacher education programs in the United States, McLean and Camp (2000) discerned that variety existed in teacher education coursework offered, but the most commonly reported course was related to methods of teaching. Due to variation in courses offered, McLean and Camp (2000) categorized coursework into five areas including (a) experiential components, (b) foundations, (c) program and curriculum planning, (d) teaching methods, and (e) teaching technology. The variety of curricular structure across institutions indicated that program offerings and design were created to align with the needs of students.



Phipps, Osborne, Dyer, and Ball (2008) asserted that agriculture education programs should seek to align with the needs of the local community. Similarly, agriculture teacher education programs may need to adapt program design and offerings according to needs of the institution and student population. As a means of increasing the strength of program design, Darling-Hammond and Bransford (2005) posited that strong teacher education programs address three major types of learning experiences to help preservice teachers gain experience developing curricula, including alignment with standards; instructional design process; and review and evaluation of curricula and lesson plans. Development of curricula often begins with end outcomes in mind, while outlining the ideal means of achieving these end results (Wiggins & McTighe, 2005). Planning ahead can ensure connection and coherence across the teacher education program and that the program is employing the best design and delivery practices while supporting student learning (Darling-Hammond & Bransford, 2005).

Instructional delivery should be designed to best meet the needs of learners. The primary goal of adjusting or modifying delivery of instruction should be to seek out strategies to improve student learning performance (Ho & Polonsky, 2009). Not only is it important to enhance student learning outcomes, but it is essential to increase the marketability of programs in higher education (Hyun, Kretoivics, & Crowe, 2006). Further research is needed regarding the most effective teacher preparation program design and delivery. Lynch (1996) suggested that major changes were necessary in the way teachers are prepared in career and technical education, and later Myers and Dyer (2004) asserted that further study of coursework configuration was required to identify experiences that best prepare future teachers. Knipe (2016) found that greater flexibility in the design of teacher preparation programs was needed to produce teachers who could work in a broad range of situations based on the rapidly changing needs of modern education. Such flexibly designed programs might be what Windschitl (2005) suggested when he emphasized that teacher education research should not be about which singular program model is most effective, but which models work best in given situations.

Teacher preparation programs have debated whether curriculum design and teaching methods courses should co-exist in the same semester or if one course should be taught prior to the other. Following Wiggins and McTighe's (2005) *Understanding by Design* (UbD) model, students must know how to design curriculum based upon global outcomes in order to build curriculum backward with the end result being the creation of daily objectives and teaching strategies. Therefore, teacher preparation programs should teach students how to design curriculum first, followed by informing students on teaching methods. The strategy to best organize course offerings has become a focal point for preservice teacher preparation programs that have numerous transfer students who take three semesters on-campus prior to their student teaching internship. Nonetheless, following the framework of UbD (2005), there is a call for curriculum design to be taught prior to teaching methods. One adjustment to teaching curriculum design and teaching methods is to allow for the completion of the two courses during one semester without overlap at an accelerated pace.

Wlodkowski (2003) defined accelerated courses as being delivered in fewer contact hours over a shorter amount of time compared to traditionally delivered courses, which typically meet face-to-face between ten and fifteen times over the course of a quarter or semester (Daniel, 2000). Accelerated courses have also been described as *block mode, compressed course, and flexible*

*mode* (Ho & Polonsky, 2009), *time-shortened courses* (Daniel, 2000), and *abbreviated courses* (Anastasi, 2007). Although originally designed to allow institutions to offer coursework within a restricted time frame (Ho & Polonsky, 2009), accelerated learning formats have been more recently offered to meet the needs of adult learners requiring flexible scheduling (Boyd, 2004; Collins, Hay, & Heiner, 2013; Daniel, 2000; Davies, 2006), as well as to meet the demands of budgeting concerns (Davies, 2006). Nontraditional students, typically defined as college students older than 24 years of age (Johnson et al., 2016), may also benefit from accelerated coursework, as they often have career, financial, and family responsibilities. Accelerated courses are often offered during summer sessions and can be useful for nontraditional students (Daniel, 2000). Utilizing accelerated coursework for teacher preparation programs can meet the needs of nontraditional students while allowing them to achieve their degree in a timely manner.

Traditional course delivery might not be best at meeting the needs of all students in higher education, including agricultural education programs (Collins et al., 2013). Thus, accelerated learning formats have become increasingly popular throughout the United States and around the world (Wlodkowski, 2003), but have been the subject of much criticism. Teaching faculty and administrators often hold the belief that accelerated courses are not as effective as traditional courses (Daniel, 2000; Scott, 2003), forsaking academic rigor for convenience.

Scott (2003) identified four major characteristics of high quality learning experiences within the context of an accelerated course: (a) instructor characteristics, (b) teaching methods, (c) classroom environment, and (d) evaluation methods. These characteristics were identified to have had strong influence over the experiences that students perceived when enrolled in accelerated courses. When these characteristics were present and positive, students were more likely to prefer accelerated coursework over traditional length courses, but when absent or negative, students described the accelerated course as becoming tedious and unpleasant. Characteristics that students desired from their instructors included (a) displaying enthusiasm for the subject, (b) incorporating student feedback regarding the course, and (c) demonstrating care concerning student learning. Perceived effective teaching methods included (a) use of active learning methods, (b) emphasis of depth versus breadth of material taught, (c) small and large group discussion, and (d) use of experiential and applied learning. In terms of the ideal classroom environment, students asserted they wanted close, trusting relationships with their peers and instructors, which would lead to increased participation. They also stressed that despite the intensity of the course, they preferred a relaxed, supportive, and nonjudgmental classroom environment. Finally, students stated that the structure of the course and types of assignments should be modified to be more easily completed in the shorter time frame, while allowing them the opportunity to apply the material in a personal way (Scott, 2003).

Although there have been suggestions for best practices of designing and delivering accelerated coursework, not much research has been conducted to help faculty understand how to best design curriculum to meet both the pedagogical needs of students and the time constraints of the compressed design. Research has found that faculty may make adjustments to the course according to the accelerated design, but these decisions were not always based on pedagogical reasons, but rather the need to fit the course into a shorter time frame (Kretovics, Crowe, & Hyun, 2005). Hyun et al. (2006) concluded that faculty teaching accelerated coursework were concerned about the amount of material needed to be taught within a shorter time frame as well

as how many courses students were allowed to take at a time. The faculty reported that students enrolled in accelerated courses were more focused, but had less time to internalize the material presented, which negatively impacted some students (Hyun et al., 2006). At the same time, faculty perceived that the nature of the accelerated course time frame might attract students of non-traditional backgrounds. However, Lee and Horsfall (2010) stated that students and faculty reported positive experiences yet noted that students raised concerns about assessment tasks and workload. Collins et al. (2013) emphasized that faculty teaching accelerated courses need to be provided with professional development and training on how to appropriately prepare them to teach courses in a compressed format, and cited strategies that institutions could take at the department, course, faculty, and university levels.

Given that literature has cited appropriately designed and delivered accelerated coursework as effective, teacher educators at the University of Florida (UF) restructured two preservice teacher courses to be delivered in an accelerated structure. The purpose of this study was to explore preservice teachers' experience while enrolled in these courses.

### **Conceptual Framework**

This study was guided by principles of *Understanding by Design* (Wiggins & McTighe, 2005). In this approach to curriculum development, curriculum writers begin with the end in mind, identifying what students should be able to know, understand, and be able to do at the conclusion of the instructional unit (Wiggins & McTighe, 2005). When establishing the desired results of instruction, designers identify appropriate enduring understandings, or the big ideas of a unit. They also list essential questions, which when posed to students, stimulate inquiry, provoke discussion, and support transfer of learning. Then, the curriculum designer determines what assessments will be used as evidence of students appropriately meeting the desired outcomes of instruction. Finally, as a last step, learning experiences and instruction are planned to be aligned with the end goal outcomes.

In addition to developing the enduring understandings, essential questions, and forms of assessment, it is vital that the educator accounts for the "scope and sequence" of the topics being delivered through the curriculum. Although high quality teaching and assessment might be developed, if they are not delivered in an appropriate order or pacing, effective learning will likely not occur. Wiggins and McTighe (2005) asserted that "sequencing the learning, mindful of performances and big ideas that recur, is as important as the quality of the curricular elements – perhaps more so, if learner engagement, understanding, and productivity are the criteria for judging the sequence" (p. 291).

In this study, the researchers used UbD to design the teacher education program. All courses in the teacher education program contributed to the program's mission statement and student learning objectives were aligned with the state's educator performance standards. Two courses were redesigned into 8-week long condensed courses. In accordance with delivering instruction in an appropriate sequence (Wiggins & McTighe, 2005), the first course to be delivered was the program's curriculum design course, followed by the delivery of the second course, instructional methods.

## Purpose and Objectives

The purpose of this study was to examine preservice teachers' learning experiences while enrolled in two accelerated teacher preparation courses. The objectives were:

1. Describe preservice teachers' perceptions of an accelerated course structure.
2. Describe preservice teachers' perceptions of content mastery and confidence while enrolled in two accelerated courses.

## Method

A mixed-methods approach was used for this study. Mixed-methods research is useful when one research method cannot fully examine the phenomenon alone (Creswell & Plano-Clark, 2011). This type of research method has become more common in recent years to address complex problems in agricultural education (Epler, Drape, Broyles, & Rudd, 2013; McCubbin, Paulsen, & Anderson, 2011; Walker, 2010; Witt, Doerfert, Ulmer, Burris, & Lan, 2013). Specifically, a convergent mixed-methods design was employed (Creswell & Plano-Clark, 2011). This design collects and analyzes quantitative data and qualitative data separately and independently from one another. The two data strands are not converged until the interpretation of the results (Creswell & Plano-Clark, 2011).

This study was conducted in the fall semester of 2016 at UF. The population was agricultural education preservice teachers enrolled in both teaching methods and curriculum design. In the past, these courses had been offered simultaneously and lasted the entire semester. The accelerated course design separated the semester in half. During the first eight weeks, preservice teachers were enrolled in the curriculum design course and were taught by an Associate Professor of Agricultural Education. The students were taught by a different Professor of Agricultural Education the second eight weeks in the teaching methods course. Each course met for six, 45-minute periods each week for eight weeks. Two of the six periods were dedicated to lab time. There were 34 students enrolled in both courses ( $N = 34$ ); 15 juniors, 16 seniors, and three master students. Data for this study were collected after the conclusion of the spring semester at a preservice teacher meeting. Twenty-seven students ( $n = 27$ ; 79% participation rate) attended the meeting and agreed to participate in the study.

Qualitative methods were used to address objective one. Focus groups were utilized because they allow participants to express ideas and opinions in a social environment, which is reflective of how attitudes are formed in everyday settings (Morgan, 1998; Perloff, 2013). Students were asked to participate in one of two focus groups at the end of the spring semester, one for junior-level students and one for senior-level students. This approach was selected because the seniors were completing their student teaching internships, and their availability was much more limited. The juniors were enrolled in a different agricultural education course and were much more accessible. To help encourage unbiased and honest answers from the students, a researcher not involved in the delivery of the courses moderated the sessions. A semi-structured moderator's guide was utilized, and students were asked about overall satisfaction of the accelerated course experience, perceptions of the lecture and lab structure, and attitudes toward the accelerated timeline for assigned coursework.

Upon completion of the focus groups, the moderator recited key themes of the discussion back to participants and asked the participants if it was an accurate summary or if they would like to add anything else. This use of member-checking ensured the accuracy and completeness of the information with the participants to account for credibility (Lincoln & Guba, 1985). Two audio-recorders were used in each focus group, and the tapes were transcribed to aid in analysis. Glaser's (1965) constant comparative method of analysis was used to identify central themes related to preservice teachers' perceptions of the accelerated course design. A peer debriefer was used during analysis of the qualitative data to play the role of *devil's advocate* and to help improve the credibility of the findings (Holloway, 1997). The peer debriefer had served as the moderator from the focus group and had no connection to the courses. An audit trail of the analysis codes as themes were identified and condensed were kept to increase the dependability of the findings and a detailed description of the students, courses, and instructors were provided to increase the study's transferability (Lincoln & Guba, 1985). Pseudonyms were used to ensure the confidentiality of the students and instructors.

Prior to the focus group sessions, the students were asked to complete a 30-item questionnaire. The items were designed to assess the preservice teachers' perceptions of content mastery and confidence that were reflective of course objectives. A 15-item, 5-point Likert-type scale was used to measure content mastery and confidence for the instructional design course (1 = strongly disagree, 2 = disagree, 3 = neither agree nor disagree, 4 = agree, and 5 = strongly agree). Similarly, 15-items, using a 5-point Likert-type scale were used to measure content mastery and confidence for the teaching methodologies course (1 = strongly disagree, 2 = disagree, 3 = neither agree nor disagree, 4 = agree, and 5 = strongly agree). A panel of experts reviewed the questionnaire prior to distribution to address face and content validity and both scales were reliable with a Cronbach's alpha greater than .70 (Field, 2013). Descriptive analysis of the data were used to address objective 2.

Data convergence was completed after the conclusion of the study. As per the convergent parallel design, both the qualitative and quantitative strands were analyzed independently (Creswell & Plano-Clark, 2011). The quantitative data provided a general understanding for the students' confidence and content mastery, while the qualitative data provided a more in-depth understanding of the students' perceptions of an accelerated course design. The two data sets were integrated and related to one another in the conclusions to provide a holistic understanding of preservice teachers' learning experiences while enrolled in two accelerated teacher preparation courses.

## Results

Objective one sought to describe preservice teachers' perceptions of an accelerated course structure. Themes which emerged included stress, challenges, and benefits.

**Stress.** The students in the junior focus group shared a consensus that they experienced "more stress" in this course than other university classes they have taken. The seniors also recognized the stress they experienced in the courses. Shelly (Sr.) stated, "I think it was a lot more stressful on us than it really needed to be. ... [It was] a very large stress on my life." The students attributed a lot of the stress to issues with the time frame in which they learned the material and

completed assignments. Their comments focused on the amount of time spent on class, the amount of time spent on assignments, and the turn-around time on assignments.

Students felt the pressure of the condensed course structure. Jen (Sr.) said, "... having them crammed into a six-week time span was a headache." Additionally, the students thought that the amount of time required of them for the condensed classes was excessive.

That was the consensus of why it was a little frustrating, because we had a lot of class time especially with the condensed eight weeks. We were meeting a lot during the week. We were meeting for four hours for lecture, and then plus we were meeting for two and a half hours for lab, so we were on campus for five and a half to six hours for this class every week, on top of you know, an online portion (Ben, Jr.).

While the juniors focused on the amount of time which was spent on assignments associated with additional elements of the course and observation hours, the seniors honed in on the amount of time which was required to produce daily lesson plans in the amount of detail expected.

I also think that just the amount of content that went into the lesson plans itself, it was more stressful because we all had other classes that we needed to worry about, and the lesson plan took up a majority of my time. And so I wasn't focusing on any other class, it's just on that one specific lesson plan (Luke, Sr.).

The seniors compared the lesson plans that they were expected to complete for these courses with the lesson plans they completed during their student teaching.

We are not creating that quality of lesson plans during our teaching experience so we really didn't have to have that. Yes, we're having to create lots of lesson plans but I don't know if I'm just speaking for myself but I don't think the quality of my lesson plans were anything like the quality of lesson plans we turned in for class (Hannah, M.S.).

Another student mentioned, "In a real-life situation, when you're in the classroom setting like that, you don't have time to plan out every single lesson in that much detail" (Casey, Sr.).

Alec (Jr.) underscored how the condensed structure created a pace which was difficult.

We met so often, but the eight weeks condensed it so much that it was like get into class and we're already by the first week we're two to three weeks ahead just like that, and it was hard to keep pace with that because by the time we got to the second half of methods, it was like first week of lab you already have a presentation to do and we just started the class.

Ally (Sr.) talked about the short turn-around time between learning and application.

We had class Monday [and] Wednesday and then we would learn the new content on Monday and those of us who were teaching on Tuesday would have to turn around in less than 24 hours and produce the quality that they wanted in less than 24 hours, while other students had until Thursday or the following week to get it done.

Hannah (M.S.) noted how the short time frames impacted the work quality. "It was all just crammed together. We didn't really have time to put in quality work for either of the classes." Additionally, Adam (Sr.) highlighted the difficulties in getting feedback from assignments in time for other assignments. "A lot of our assignments we would finish it and then we would have

three or four days before the next one's due, before we'd ever get feedback. We can't do this lesson without the feedback to do the next one."

Students spoke of the impacts of the stress on their lives and how they chose to cope with the stress. Two of the seniors admitted to experiencing panic attacks during the course. For example, Kelly (Sr.) said, "I did have several panic attacks. It was not good to(sic) my mental health for sure. It was a pretty traumatizing experience." When asked how they dealt with the stress many students admitted to just not doing their work. "I just didn't do it" (Maria, Jr.). The juniors' focus was on not completing the online videos required in the flipped classroom portion of the teaching methods course. "I just quit watching the online lecture" (Maria, Jr.). "I tried to watch as many of the videos as I could ... We would have a lot of times where a lot of people in the class the next day would be like we didn't see the video" (Jackie, Jr.). However, the seniors admitted to not completing lesson plans for the teaching methods course.

Because of the panic attacks, after the first lesson plan, I didn't turn in any other lesson plans. My grade suffered and I barely skimmed by, but I did not turn them in because I had more things that I needed to take care of (Ally, Sr.).

David (Sr.) followed up on that thought. "I didn't do one of them too and it was because it's like I could spend five hours trying to make the perfect lesson plan or I could just not do it,"

Another senior addressed how the amount of classwork impacted his physical health.

I was staying up until three, four in the morning, getting up at seven, being at class, going to work, staying up until four or five o'clock, and I got sick four times last semester and I don't get sick. Because I was run down so much, I was sleeping two to three hours a night and that was it (Adam, Sr.).

Another senior talked about the impact of the stress from the courses on her home-life. "I know there's a few of us too that have families, like little kids, and all that suffers. Everything suffers because you're trying to concentrate on this and your family suffers and everything" (Ann, Sr.).

**Challenges.** Students in both focus groups discussed issues related to clarity of expectations, schedule of coursework, types of assessments, and rapport with professors. Several students identified issues with clarity in expectations which stemmed from ineffective planning and communication. Shelly (Sr.) said, "I don't think it was very well thought out." Mia (Jr.) also noted, "I believe 4202 [curriculum design] had a direct point of what the goal was, which was writing curriculum. ... 4200 [teaching methods] to me was not as clear about what we were supposed to gain." Morgan (Jr.) expanded on the previous response saying,

[It's] not like the way it [curriculum design] was taught was bad, but it was very scattered, was a good way to put it. Like, lectures in person, lectures online, quizzes online, teaching different inquiry-based learning and then different sections that we were teaching I felt like it wasn't quite as clear that this is exactly what we wanted. It's not like this is the right way to do it, this is the wrong way to do it, so it was kind of like stumbling, not stumbling through the dark, but you just have to stumble through the dark a little bit.

Another student remarked,

I think planning from the very, very top has kind of caused most of these issues. And if the entire class had been planned and thought out a little bit better then maybe the

communication, maybe the grading, maybe the expectations and everything would've been better (Claire, Sr.).

Hannah (M.S.) stated, "I didn't see the connection from professor to professor. Dr. Smith tried his best. Dr. Jones tried his best. But not communicating hindered that."

They noted inconsistencies in expectations between the two courses.

The goal of it, I feel, was to take what we had done in the curriculum class and then put it into use in the methods class. And, that worked except some things in the methods class weren't the same that we were learning in the curriculum class and vice versa so it threw us off a little bit. But, it helped that we had the same TA so we could work out those problems (Aaron, Jr.).

Another student noted the challenges of unclear expectations. "I thought that it was difficult because we were developing curriculum, but then we didn't know exactly how they wanted us to teach it" (Tanya, M. S.).

Several of the students underscored issues with when the course work was offered during their program of study. The juniors, who were mostly transfer students, felt ill-prepared to take these courses during their first semester in the program and at the university. "I just feel like it was my first semester here and I've never taken teaching classes before. It was a lot. In the second or third week we had to have pretty much our whole curriculum done" (Abigail, Jr.). Another student remarked,

There were a lot of the seniors that we were taking that class with that had addressed to me that these were the hardest classes that they had taken at UF the whole time that they had been here. And we're taking them as our first class. And a lot of them are transfers too. Some of them came in as freshmen, but myself and the transfer students, it was my first class at UF and I have the seniors saying it's the hardest class they have to take (Aaron, Jr.)

Students did not feel that the assessments used were the most accurate. For example, when referring to quizzes based on the online lecture, one student said, "... [The professor] was expecting us to come regurgitate in a memorization pattern which is not okay for a student to try and learn the material and synthesize it" (Mia, Jr.). Another student said,

That class [teaching methods] didn't offer really a proper assessment to how we were learning. ... I also felt that the quizzes [in curriculum design] that we were given were unfair because the quizzes didn't properly assess what we were talking about or learning. So for example, a lot of the quizzes were very short answer type questions, and they were multiple choice. We never really would kinda go back to those assessments and talk about what was the right answer, what should've been on that. So I just felt like there were challenges to both classes but they were both a little bit different (Tim, Sr.).

Some students commented on the lack of rapport they had with one of the professors.

I know some of us felt that it was kind of awkward going from a professor that we know so well and knows us so well to a professor that we've seen in passing. Getting to know professors better I think might have been a little bit easier, but going from one class and



then jumping into one where you don't really know the professor is kind of like, who are you and why are you telling me what to do? (Jen, Sr.)

Not once, I don't think and I'm going to be completely honest, that I think Dr. Smith offered to meet with any students or try to watch our presentations, see how we were doing in the class, ask if we were adequately understanding or even getting anything out of his videos. So that's why I think a lot of us felt that disconnect and had issues with the class (Mia, Jr.).

In response to the previous comment another student replied, "I mean it's hard to put in that many hours a week when you feel like your time isn't appreciated at all" (Maria, Jr.).

**Benefits.** The students did acknowledge benefits they recognized from the condensed course structure. Benefits included, learning good time management skills, realizing the amount of time it took to create lessons, the amount of information they learned, and the value of the laboratory experience. Jackie (Jr.) highlighted the first two benefits in one statement.

I think the class definitely helped us learn a little bit of time management tools, and the amount of time that it takes to make lesson plans and curriculum maps and all of that good stuff. So, in that sense I think it did a good job at preparing us for the time challenges we'll have to meet when we're actually in the field.

The students realized that they learned a lot through the semester.

The curriculum development part of the class, was really, really good. I feel like I learned a tremendous amount from where to find certain things, how to structure it, why things are structured the way they are, and how to incorporate different teaching methods in a lesson plan. Why you should leave the sub plans that are very easy to read, like that kind of stuff. I really learned a lot (Maria, Jr.).

I know for a lot of us, whenever we went into it, whenever we were talking about teaching and making lesson plans, and we had to make lesson plans for other classes, we thought about the activity and then matched it with something that you would teach in that class. And because we had the curriculum class and then the teaching methods class, they made us flip our brains around where you have to look at your standards and then plan from there. So I felt that was advantageous especially when you did the internship and getting classes that maybe you haven't taught before, you really have to look at those standards and then match something that the students would enjoy (Jen, Sr.).

I feel it was pretty well stressed to us like she said, start with your standards, then come up with your objectives, that's something that stuck in my mind, when throughout my internship when I was creating a lesson plan I would identify my objectives first and then I would worry about what am I going to do with these. So I thought that was something I took away from it (Casey, Sr.).

The laboratory periods associated with the courses were valued by the students. Although they acknowledged that they were "not like a real-life classroom" (Beth, Sr.), they acknowledged that "the labs were really helpful, especially since we got to provide feedback to one another, and hear from our classmates. ... it's still great that you get to go through the practice of going through your whole entire lesson" (Beth, Sr.). Tanya (M.S.) said, "I liked watching each other

teach and the way that we taught in front of our peers and were able to have that safe environment to help each other and learn different strategies and techniques from each other.”

Objective two sought to describe preservice teachers’ perceptions of content mastery and confidence while enrolled in two accelerated courses. Table 1 reports the means for each learning objective identified in the instructional design course. The learning objectives with the highest means, indicating the highest level of preservice teachers’ perceptions of content mastery and confidence, were *create a course syllabus for a class* ( $M = 4.52$ ;  $SD = 0.58$ ), and *successfully and independently develop a unit plan for a course* ( $M = 4.44$ ;  $SD = 0.58$ ).

Table 1  
*Preservice teacher confidence in instructional design after completing an accelerated course*

<i>Item</i>	<i>Mean<sup>a</sup></i> <i>(M)</i>	<i>SD</i>
Create a course syllabus for a class	4.52	0.58
Successfully and independently develop a unit plan for a course	4.44	0.58
Write daily instructional plans for a course	4.37	0.79
Create behavioral objectives according to Bloom’s Taxonomy	4.30	0.72
Select appropriate formative assessment strategies	4.30	0.72
Create a grading rubric for a course assignment that effectively measures student performance	4.26	0.81
Create a written assessment	4.23	0.91
Successfully create essential questions that guide course planning	4.19	0.88
Incorporating differentiated instructional strategies to meet a variety of learners	4.15	0.66
Use the Understanding by Design process to create course curriculum	4.11	0.64
Generate appropriate student feedback	4.11	0.80
Create a curriculum map for a course	3.96	0.71
Create a classroom management plan	3.89	0.85
Utilize student data appropriate to inform curriculum decisions	3.78	0.85
Explain Robert and Ball’s (2009) model for agricultural subject matter	3.11	1.01

Note: <sup>a</sup>Scale range was (1=strongly disagree to 5=strongly agree)

Table 2 reports the means for each learning objective identified in the teaching methodologies course. The learning objectives with the highest means were *use lecture as a teaching technique in my lessons* ( $M = 4.59$ ;  $SD = 0.50$ ) and *use an interest approach or activity design to stimulate student interest in my teaching* ( $M = 4.48$ ;  $SD = 0.64$ ).

Table 2

*Preservice teacher confidence in teaching after completing an accelerated course*

<i>Item</i>	<i>Mean<sup>a</sup> (M)</i>	<i>SD</i>
Use lecture as a teaching technique in my lessons	4.59	0.50
Use an interest approach or activity design to stimulate student interest in my teaching	4.48	0.64
Use demonstration teaching techniques in my lessons	4.44	0.70
Summarize a lesson while teaching in a classroom	4.37	0.57
Use questioning as a teaching technique in my lessons	4.37	0.69
Use student-centered learning activities appropriately while I teach in the classroom	4.30	0.54
Use cooperative learning activities when I teach in the classroom	4.30	0.54
Use teacher-centered learning activities when I teach in the classroom	4.30	0.47
Apply characteristics of good instruction and teaching when I teach in the classroom	4.26	0.71
Identify factors affecting individual learner differences	4.04	0.90
Effectively use case studies as a teaching technique in my lessons	4.00	0.69
Use inquiry teaching techniques while teaching in a classroom	4.00	0.83
Prepare lesson plans that address diversity in student populations	3.96	0.85
Use educational technology while I teach in the classroom	3.85	1.13
Effectively manage student behavior while teaching in a classroom	3.63	1.18

Note: <sup>a</sup>Scale range was 1=strongly disagree to 5=strongly agree)

### **Conclusions, Recommendations, and Implications**

Based on the results, several conclusions can be drawn. First, students were largely dissatisfied with the accelerated class format. They reported feeling stressed and noted many challenges to meeting course expectations in the accelerated format. However, they did note some benefits like time management and realistic expectations for teachers. Similar student challenges were identified by Hyun et al. (2006) and Lee and Horsfall (2010). Concerns raised by students regarding instructor characteristics, teaching methods, and evaluation methods align with the perceptions of students in Scott's (2003) description of attributes of high-quality intensive learning experiences. Based on student perceptions in this study, these courses did not meet Scott's criteria.

Secondly, students perceived they mastered the concepts from both courses. Although they did not prefer the accelerated course structure, it appears to have been successful in helping students gain confidence in necessary skills. From a UbD perspective (Wiggins & McTighe, 2005), the courses were successful. However, it is important to note this was self-perceived mastery and confidence, not actual demonstration of mastery or knowledge. Additionally, a pre-test of confidence in content was not collected to determine how the students' confidence changed after completion of the courses. Another influence on the students' perceptions of content mastery was that the data was collected a full semester after the courses were completed. The seniors may have gained confidence in their abilities through their supervised teaching experiences, and the juniors may have gathered confidence during their spring courses.

Overall, based on results of this research, it is recommended that the courses be reformatted back to the traditional semester delivery until additional data can be collected. The original motive was to sequence the delivery of the courses so students take the curriculum design course prior to the teaching methods course. It is recommended that the curriculum design course be moved to the semester prior to the teaching methods course. Other universities exploring the accelerated course structure should consider affective and cognitive outcomes. Additionally, universities should carefully review their entire teacher education curricula before adopting an accelerated course format. An experimental design could explore differences in students' learning, confidence, and satisfaction between the traditional and accelerated course format through a longitudinal study over two to three years. This may provide more accurate justification for using one course design over another.

The results from this study cannot be generalized; however, the findings should provide guidance to educators who offer accelerated courses. Ensuring open and transparent communication between students and instructors can help to decrease stress levels and perceptions of challenges. Also, if accelerated course are to be taught in tandem with different instructors, care should be taken to ensure the connection and coherence of course content and assignments (Darling-Hammond & Bransford, 2005). A final recommendation is to adjust the teaching methods, assignments, and evaluations to be appropriate for the accelerated pace (Scott, 2003). Although initial feedback from students was not positive, they did perceive to have mastered concepts from both courses. Additional research could follow-up with students after some time has passed to see if they still have similar perceptions of the format. Additionally, students' actual performance during their student teaching internships could be a better indicator of content mastery.

## References

- Anastasi, J. S. (2007). Full-semester and abbreviated summer courses: An evaluation of student performance. *Teaching of Psychology, 34*(1), 19-22. doi: 1080/00986280709336643
- Barrick, R. K., & Garton, B. L. (2010). Frameworks for agriculture teacher preparation. In R. M. Torres, T. Kitchel, & A. Ball (Eds.), *Preparing and advancing teachers in agricultural education* (pp. 30-41). Columbus, OH: The Ohio State University.
- Boyd, D. (2004). Effective teaching in accelerated learning programs. *Adult Learning, 15*(1-2), 40-43. doi:10.1177/104515950401500111
- Collins, A., Hay, I., & Heiner, I. (2013). Start with the end in mind: Experiences of accelerated course completion by pre-service teachers and educators. *Australian Journal of Teacher Education, 38*(10), 1-20. doi: 10.14221/ajte.2013v38n10.4
- Creswell, J. W., & Plano-Clark, V. L. (2011). *Designing and conducting mixed methods research* (2nd ed.). Thousand Oaks, CA: SAGE Publications.

- Daniel, E. L. (2000). A review of time-shortened courses across disciplines. *College Student Journal*, 34(2), 298-309. Retrieved from <https://www.questia.com/library/p1917/college-student-journal>
- Darling-Hammond, L., & Bransford, J. (Eds.) (2005). *Preparing Teachers for a Changing World: What Teachers Should Learn and Be Able to Do*. San Francisco, CA: John Wiley & Sons, Inc.
- Davies, W. M. (2006). Intensive teaching formats: A review. *Issues in Educational Research*, 16(1), 1-20. Retrieved from <http://www.iier.org.au/iier.html>
- Epler, C. M., Drape, T. A., Broyles, T. W., & Rudd, R. D. (2013). The influence of collaborative reflection and think-aloud protocols on pre-service teachers' reflection: A mixed methods approach. *Journal of Agricultural Education*, 54(1), 47-59. doi: 10.5032/jae.2013.01047
- Field, A. (2013). *Discovering statistics using IBM SPSS statistics* (4th ed.). Thousand Oaks, CA: SAGE.
- Glaser, B. G. (1965). The constant comparative method of qualitative analysis. *Social Problems*, 12(4), 436-445. Retrieved from <http://www.sssp1.org/index.cfm/m/325>
- Holloway, I. (1997). *Basic concepts for qualitative research*. Oxford, UK: Blackwell Publications.
- Ho, H., & Polonsky, M. (2009). Exploring marketing students' attitudes and performance: A comparison of traditional and intensive delivery. *Marketing Education Review*, 19(3), 41-47. doi: 10.1080/10528008.2009.11489086
- Hyun, E., Kretovics, M. & Crowe, A. (2006). Curriculum characteristics of time-compressed course in a U.S. higher education institution. *Educational Research and Review*, 1(2), 29-39. Retrieved from <http://www.academicjournals.org/journal/ERR>
- Johnson, M. L., Tassoobshirazi, G., Clark, L., Howell, L., & Breen, M. (2016). Motivations of traditional and nontraditional college students: From self-determination and attributions, to expectancy and values. *Journal of Continuing Higher Education*, 64(1), 3-15.
- Knipe, S. (2016). Innovation in course design. *Australian Journal of Teacher Education*, 41(3). doi: 10.14221/ajte.2016v41n3.4
- Kretovics, M. A., Crowe, A. R., & Hyun, E. (2005). A study of faculty perceptions of summer compressed course teaching. *Innovative Higher Education*, 30(1), 37-51. doi: 10.1007/s10755-005-3295-1
- Lee, N., & Horsfall, B. (2010). Accelerated learning: A study of faculty and student experiences. *Innovative Higher Education*, 35(3), p 191-202. doi: 10.1007/s10755-010-9141-0

- Lincoln, Y., & Guba, E. G. (1985). *Naturalistic inquiry*. Beverly Hills, CA: Sage.
- Lynch, R. L. (1996). In search of vocational and technical teacher education. *Journal of Career and Technical Education*, 13(1), 5-16. doi: 10.21061/jcte.v13i1.508
- McCubbins, O. P., Paulsen, T. H., & Anderson, R. G. (2016). Student perceptions concerning their experience in a flipped undergraduate capstone course. *Journal of Agricultural Education*, 57(3), 70-86. doi: 10.5032/jae.2016.03070
- McLean, R. C., & Camp, W. G. (2000). An examination of selected preservice agricultural teacher education programs in the United States. *Journal of Agricultural Education*, 41(2), 25-35. doi: 10.5032/jae.2000.02025
- Morgan, D. L. (1998). *The focus group guidebook*. Thousand Oaks, CA: Sage Publications, Inc. [http://www.careernetwork.org/career\\_journal.html](http://www.careernetwork.org/career_journal.html)
- Myers, B. E., & Dyer, J. E. (2004). Agriculture teacher education programs: A synthesis of the literature. *Journal of Agricultural Education*, 45(3), 44-52. doi: 10.5032/jae.2004.03044
- Perloff, R. M. (2013). *The dynamics of persuasion: Communication and attitudes in the 21st century* (4th ed.). New York, NY: Routledge.
- Phipps, L. J., Osborne, E. W., Dyer, J. E., & Ball, A. L. (2008). *Handbook on agricultural education in public schools*. Clifton Park, NY: Thompson Learning.
- Robert, T. G., & Ball, A. L. (2009). Secondary agricultural science as a content and context for teaching. *Journal of Agricultural Education*, 50(1), 81-91. doi: 10.5032/jae.2009.01081
- Scott, P. (2003). Attributes of high-quality accelerated courses. In R. J. Wlodkowski & C. E. Kasworm (Eds.), *Accelerated learning for adults: The promise and practice of intensive educational formats* [special issue]. *New Directions for Adult and Continuing Education*, 97, 29-38. doi: 10.1002/ace.86
- Walker, N. J. (2010). An examination of integration of academic and vocational subject matter in the aquaculture classroom. *Journal of Agricultural Education*, 41(2), 54-64. doi:10.5032/jae.2000.02054
- Wardlow, G. W., & Osborne, E. W. (2010). Philosophical underpinnings in agricultural education. In R. M. Torres, T. Kitchel, & A. Ball (Eds.), *Preparing and advancing teachers in agricultural education*, (pp.17-29). Columbus, OH: The Ohio State University.
- Wiggins, G. P., & McTighe, J. (2005). *Understanding by Design*. Association for Supervision and Curriculum Development. Alexandria, VA.

- Windschitl, M. (2005). The future of science teacher preparation in America: Where is the evidence to inform program design and guide responsible policy decisions? *Science Education*, 89(4), 525-534. doi: 10.1002/sce.20090
- Witt, C., Doerfert, D. L., Ulmer, J. D., Burris, S., & Lan, W. (2013). An investigation of school contentedness among agricultural education students. *Journal of Agricultural Education*, 54(2), 186-204. doi: 10.5032/jae.2013.02186
- Wlodkowski, R. (2003). Accelerated learning in colleges and universities. In R. J. Wlodkowski & C. E. Kasworm (Eds.), *Accelerated learning for adults: The promise and practice of intensive educational formats* [special issue]. *New Directions for Adult and Continuing Education*, 97, 5-16. doi: 10.1002/ace.84

## **Relationship Between Career and Technical Education Student Teachers' Self-Efficacy and edTPA Performance**

Victoria P. Whitley, North Carolina State University  
Travis D. Park, North Carolina State University  
Wendy J. Warner, North Carolina State University  
Erin T. Horne, North Carolina State University

### **Abstract**

Our national education system is in need of quality novice teachers possessing positive efficacy. The edTPA, a validated teacher performance assessment, is being used across the nation to assess the readiness of student teachers for a successful career in education. Since self-efficacy is most heavily correlated with early experiences, it is important to understand self-efficacy during student teaching when the edTPA is being completed. The purpose of this study was to gain a better understanding of the relationship between edTPA and student teacher's self-efficacy throughout their student teaching. This quasi-experimental study compared mean of self-efficacy as measured by the Teacher Self-Efficacy Scale (TSES) to edTPA scores from Agricultural Education and Technology Education student teachers at North Carolina State University. This study found a negative correlation between self-efficacy means at the end of the student teaching semester and overall edTPA score. Self-efficacy in some students was found to decrease after internal submission when given feedback on progress and performance. All participants were shown to increase in self-efficacy from the beginning to the end of the student teacher.

### **Introduction**

During student teaching, student teachers begin to form pedagogical habits and styles that persist throughout a teaching career. Self-efficacy plays a role in the molding of the pedagogical style a novice teacher adopts. Therefore, self-efficacy is researched to understand the affects it has on overall performance and success of teachers in these early years. Since student teaching is typically one of the first mastery experiences a teacher has, student teachers become the focus for self-efficacy research.

According to the United States Department of Labor (2015), the demand for high school teachers will increase by 6% or 55,900 jobs from the year 2014 to 2024. The need for student achievement has reached an all-time high and the need for more highly qualified, effective teachers has grown in proportion to growing school systems. To accumulate highly qualified teachers, education leaders can investigate many different teacher characteristics including self-efficacy. Teacher efficacy is a teacher's beliefs about their ability to perform tasks necessary to the process of teaching and educating students (Friedman & Kass, 2002).



## **Theoretical and Conceptual Framework**

### **Self-Efficacy Relevancy**

Bandura (1997) was one of the first to research efficacy and its relationship to human behavior. He defined self-efficacy as a person's belief of their ability and capacity to execute necessary tasks to accomplish a desired goal. In simpler terms, it is a person's perception of their ability to perform. A person bases his or her feelings of efficacy more heavily on their perceived level of motivation, affective states, and actions, rather than the objective reality (Bandura, 1997). Self-efficacy is considered, in research, as a valuable indicator of job performance, job satisfaction (Klassen & Chiu, 2010), recruitment and retention (Wheeler & Knobloch, 2006), and student achievement (Caprara, Barbaranelli, Steca, & Malon, 2006). Therefore, a person's effectiveness in their work can be linked to their efficacious beliefs.

### **Teacher Preparation Programs**

In his theory of self-efficacy, Bandura (1994) suggested efficacy is most pliable in the early years of learning. The early years of learning for teachers applies to the preservice years and the first years of teaching. Preservice years are termed as student teaching and the first years of teaching are also known as the induction phase. Therefore, the experiences of a preservice teacher are important influences on the long-term development of teacher efficacy and success in an educational career. Having a strong influence on teacher efficacy means teacher education programs have a responsibility to carefully construct learning environments (Gordon & Debus, 2002), which are conducive for efficacy building. Additionally, teacher education programs are responsible for the teaching of pedagogy and placing students in student teaching placement sites where early mastery experiences are most likely to occur.

In general, educational organizations strive to bring consistency to assessments and evaluation standards to ensure fairness and equality of students and teachers (Every Student Succeeds Act, 2015). Having standardized assessment tools creates consistency for school leaders when evaluating candidates for teaching positions. The same is applied to teaching licensure candidates in undergraduate programs. University-wide and discipline-wide adoption of specific program approaches is necessary because of the interdependent nature of the education profession (American Association of Colleges for Teacher Education, 2017). It is important for teachers to be transferable within and between school systems for stability amongst educational communities. Consistency among preparation programs is helpful in transforming the educational system to fit 21<sup>st</sup> century educational goals and visions (American Association of Colleges for Teacher Education, 2017).

In addition to the actual classroom experiences, teacher preparation programs and evaluation tools used to assess preservice teacher preparedness can be influential in the development of efficacy. The goal of teacher preparation programs is to produce teacher candidates that can effectively plan, teach, and assess student learning (Whittaker & Nelson, 2013), and the focus of the program should be on the process of teaching and learning (Myers & Dyer, 2004).

## **Educational Teacher Performance Assessment (edTPA)**

The demands of the education profession support the need for clear evidence of teacher preparedness and positive effect on students' learning (American Association of Colleges for Teacher Education, 2017). Universal standards ensure all teachers entering the classroom meet uniform and robust standards of competence (American Federation of Teachers, 2012). In an effort to provide a more standardized assessment of student teacher competence upon entering the profession, an assessment tool known as the Educational Teacher Preparation Assessment (edTPA) was created by the Stanford Center for Assessment, Learning, & Equity (SCALE). The edTPA was designed with similarities to the National Board for Professional Teaching Standards certification.

Currently, 746 programs across 40 states, including North Carolina State University have adopted the use of the edTPA program for teacher candidates (American Association of Colleges for Teacher Education, 2017) to produce highly qualified and prepared novice teachers. The founding premise of the edTPA program is that a teacher candidate will demonstrate their ability to perform in the classroom (Sato, 2014) by developing and evaluating student learning (SCALE, 2014). With the use of detailed plans, videoed instruction, and evidence of student work (Darling-Hammond, 2012), the edTPA portfolio addresses planning, instruction, assessment, reflection, and academic language to reveal the competence of the teacher candidate (SCALE, 2014).

Many university teacher preparation programs have faced the challenge of adequately preparing students for completing the edTPA requirements. Along with maintaining the core elements of a teacher preparation program, the rigorous implementation of the edTPA can prove to be ambitious for program leaders (Miller, Carroll, Jancic, & Markworth, 2015). Support and strategy recommendations will be useful to university teacher preparation programs facing this challenge. Therefore, edTPA research will provide program leaders with data to support program decision and construction. As a result, program leaders will be able to integrate better instructional methods and efficacy building experiences into preparation programs that will ultimately benefit edTPA scores.

### **Purpose/Objectives**

The purpose of this study is to examine the relationship between efficacy trends of Agricultural Education and Technology Education preservice teachers at North Carolina State University to proficiency on teacher candidate assessment. Efficacy trends are compared to edTPA performance data for determination of the effect edTPA has on teacher efficacy. This study was guided by the following research objectives:

1. Describe the changes that occur to a student teacher's self-efficacy throughout their student teaching semester.
2. Determine the relationship between student teacher self-efficacy at various points in the edTPA portfolio completion process and performance on edTPA.

## Methodology

Participants of this study included undergraduate students at North Carolina State University in the teacher preparation undergraduate degree programs in Agricultural Education ( $n=15$ ) and Technology Education ( $n=9$ ). It is important to note that the sample of participants is a small size based on research sample size recommendations (Krejcie & Morgan, 1970). Since the population of Agricultural Education and Technology Education pre-service teachers is relatively small at this university ( $n=24$ ), a census was conducted on the population selected. Prior to introducing the study to the participants, program leaders assigned each student with an individual participant code to protect the identity of the participant. One participant from each participant group was removed from the study due to unmet student teaching requirements. The resulting Agricultural Education participant group was 14, and the resulting Technology Education participant group was eight. Participants were completing their student teaching experience in the spring semester of 2017 in which edTPA was first being implemented as a non-pilot, high-stakes teacher candidate assessment.

### Instrumentation

Survey methods included a collection of quantitative data and utilized a previously developed questionnaire. The instrument used was the Tschannen-Moran and Hoy (2001) Teacher Sense Efficacy Scale (TSES). There are two forms of this instrument, a long form with 24 items and a short form with 12 items. This study used the 12-item short form because it is recommended for preservice teachers. The factor analysis performed on this instrument assigned a single factor structure because the observed variables are like each other and easily distinguishable from other items (Tschannen-Moran & Hoy, 2001). Another reason for using the 12-item form is because of the number of times participants were to be surveyed and the possibility of participant burnout. The scale consists of 12 questions measuring three teaching self-efficacy constructs: student engagement, instructional strategies, and classroom management. Responses were obtained through a Likert-type scale ranging from 1 (*Nothing*) to 9 (*A Great Deal*). Reliability of the 12-item scale is  $\alpha = 0.90$ . The results of the construct validity analysis of the 12-item scale proved to be like the results of the 24-item long form.

The scale was converted to an online form distributed by email to participants. In addition to the TSES scale, questions were added to the end of the questionnaire to provide indicating information about the progress status of the edTPA for the participant. These questions allowed the researcher to match the efficacy to the exact point in time during the participant's student teaching semester.

### Data Collection and Analysis

The study was introduced to each participant group one week prior to their student teaching placement began. Participants were given the TSES electronic questionnaire via email at nine benchmarks throughout their students teaching semester (see Table 1).

To statistically analyze the overall trends of self-efficacy, mean TSES scores and standard deviations were calculated. Means were calculated to represent total TSES and each

individual TSES construct. Line graphs were used to visually represent the change in self-efficacy. Pearson product-moment correlations, Pearson  $r$ , were calculated to determine whether any statistically significant relationships existed between the participants' self-efficacy and edTPA performance. This analysis was used to assess the correlation between self-efficacy  $s$  and edTPA  $s$  (individual task  $s$  and total overall score). Pearson  $r$  was also used to calculate change in self-efficacy ( $\Delta$ SE) from the initial (T1) data collection benchmark to the final (T7) benchmark.  $\Delta$ SE represents the percentage of increase from the initial TSES to the final TSES mean. An alpha level of ( $\alpha=.05$ ) was determined *a priori* for this analysis.

Table 1

*Data Collection Schedule*

Agricultural Education	Benchmark	Technology Education
1/9	T1 Pre-student teaching	1/11
1/25	T2 First week student teaching	1/27
2/15	T3 Midpoint, after edTPA taping	2/8
2/27	T4 Just before internal submission	--- <sup>a</sup>
3/24	T5 edTPA to Pearson	3/17
4/17	T6 Just before receiving $s$	--- <sup>a</sup>
4/27	T7 Post scores	4/26

<sup>a</sup> Participants did not participate in the data collection benchmark.

## Findings

### Objective 1: Describe the Change in Student Teacher Self-Efficacy

The purpose of determining the changes in participants' self-efficacy was to be able to describe the trends found among all participants and the individual participant groups. The total self-efficacy means, as measured by the TSES, increased for all participants in the study (see Table 2). The initial TSES mean for all participants ( $n=22$ ) was 6.00 and the final was 7.65 out of a maximum possible of 9.00. Mean change from the initial to the final gradually increased throughout the data collection benchmarks.

Table 2

*Self-Efficacy Means of the TSES from all Student Teachers*

Benchmark	Self-Efficacy $s$		
	$N$	Mean	$SD$
T1- Pre-Student Teaching	22	6.00	0.66
T2- First Week of Teaching	26	6.16	1.07
T3- After Taping edTPA Lesson	19	6.63	0.82
T4- Internal Submission	11	7.18	1.20
T5- Submit edTPA to Pearson	25	7.21	0.98
T6- Just Before Receiving $s$	12	7.36	1.16
T7- Post $s$	22	7.65	1.06

*Note.* The maximum Self-Efficacy is 9.00.

The self-efficacy means of each individual construct (classroom management, instructional strategies, and student engagement) and the cumulative self-efficacy increased over the study for all participants (see Table 3 and Figure 1). The highest initial mean self-efficacy for all participants was classroom management at 6.20 out of a total of 9.00 as the maximum possible. The lowest initial mean score was for student engagement at 5.80. Before student teaching, participants had an overall perception that they were most efficacious in classroom management and least efficacious in student engagement.

Table 3

*Comparison of Self-Efficacy Means for all Constructs of the TSES from all Student Teachers*

Benchmark	Means		
	<i>Classroom Management</i>	<i>Instructional Strategies</i>	<i>Student Engagement</i>
T1- Pre-Student Teaching	6.20	5.91	5.80
T2- First Week of Teaching	6.34	6.34	5.78
T3- After Taping edTPA Lesson	7.02	7.00	5.86
T4- Internal Submission	7.37	7.31	6.75
T5- Submit edTPA to Pearson	7.16	7.16	6.75
T6- Just Before Receiving s	7.50	7.50	7.04
T7- Post s	7.68	7.84	7.43

*Note.* The maximum Self-Efficacy is 9.00.

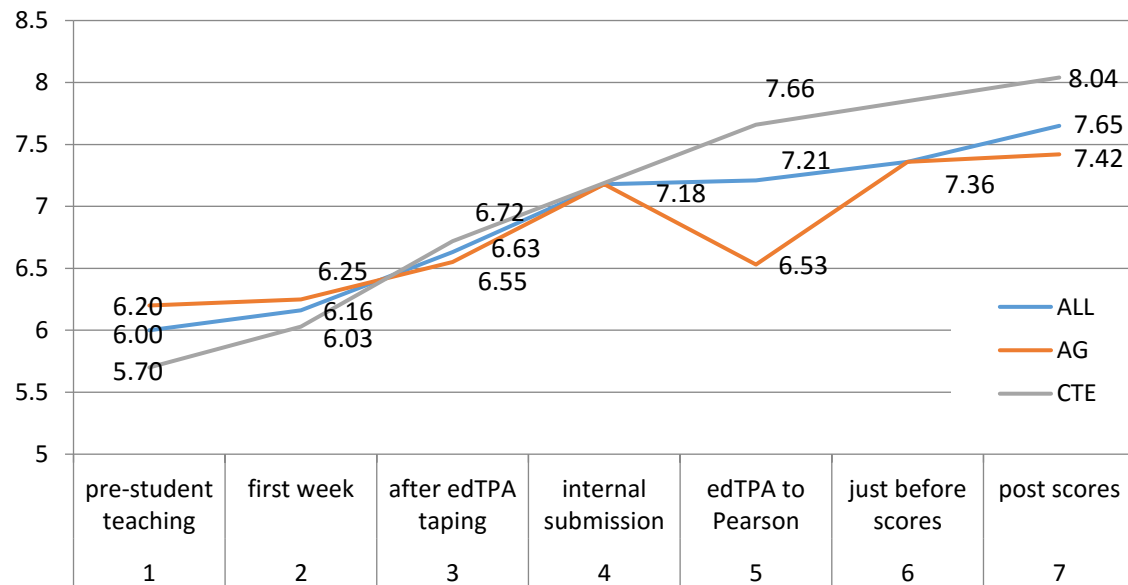

*Figure 1.* Change in overall self-efficacy for all student teachers

Technology education participants began in the “pre-student teaching” benchmark with a lower mean self-efficacy of 5.70 compared to the agricultural education participants who began with a mean of 6.20. At the “post scores” benchmark, technology education participants had a higher final mean of 8.04 compared to the agricultural education group’s mean final of 7.42.

Mean self-efficacy for all participants increased over the student teaching semester (see Figure 2, 3, and 4). Classroom management self-efficacy had the highest initial at 6.20 while student engagement was the lowest at 5.80 (see Figure 2). Final means resulted in participants feeling most efficacious in instructional strategies at 7.84 and lowest in student engagement at 7.43. Student engagement remained the lowest efficacy for all participants from the beginning to the end of the study.

Agricultural education participants (see Figure 3) experienced a decrease in mean efficacy in benchmark T5 (edTPA submitted to Pearson) unlike the technology education participants. Technology education participants (see Figure 4) did not experience a decrease in any area of self-efficacy. Technology education self-efficacy means gradually increased consistently from the beginning to the end of the study.

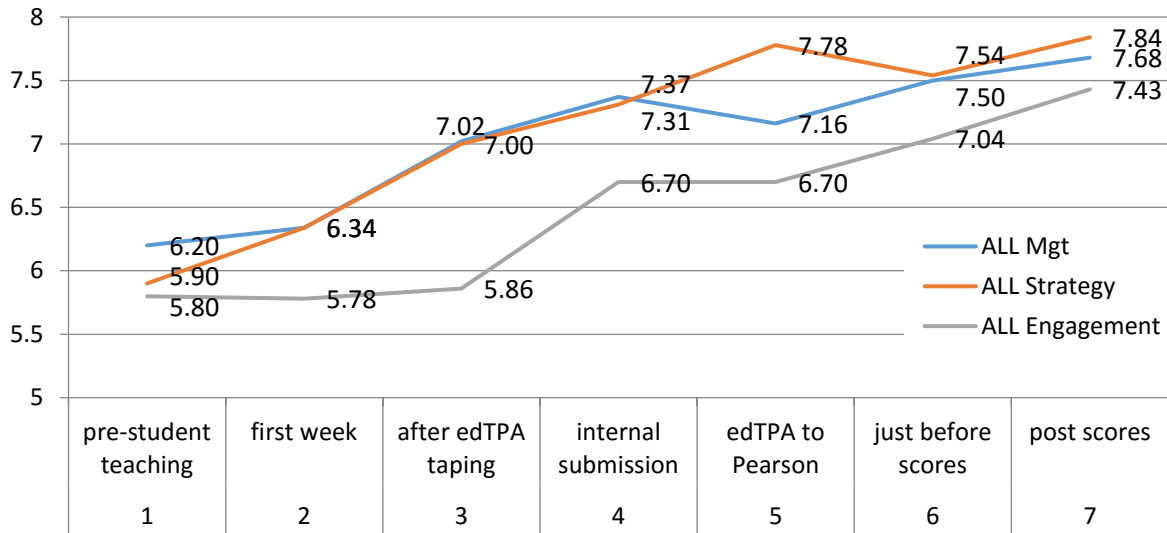

Figure 2. Change in Self-efficacy for all student teachers in TSES construct areas

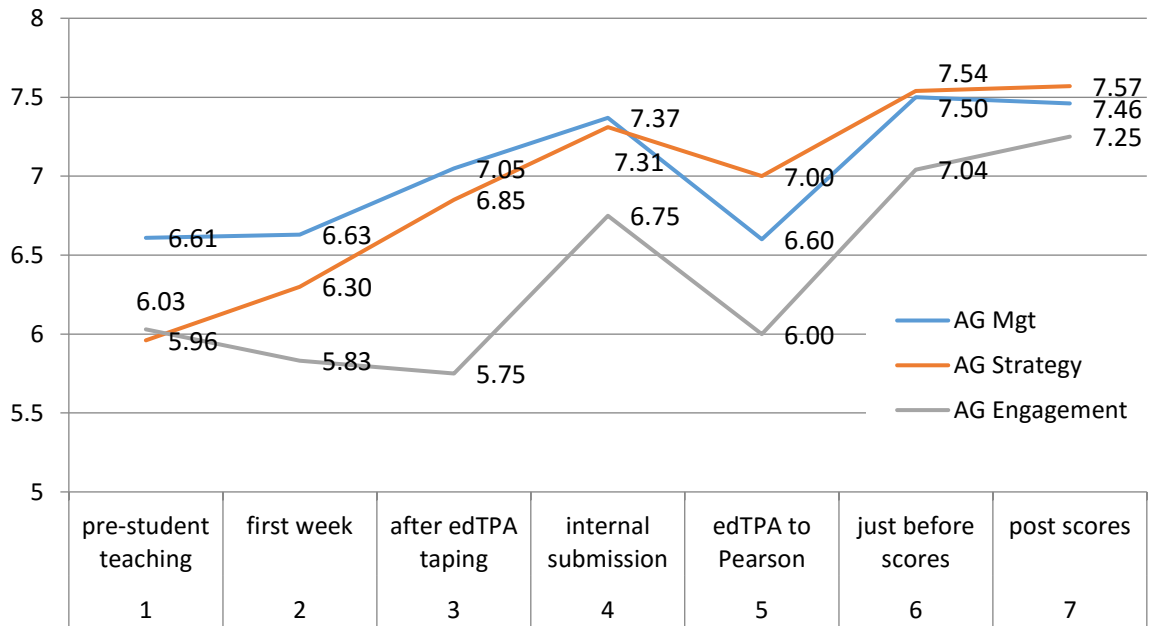

Figure 3. Change in self-efficacy for agriculture student teachers in TSES construct areas

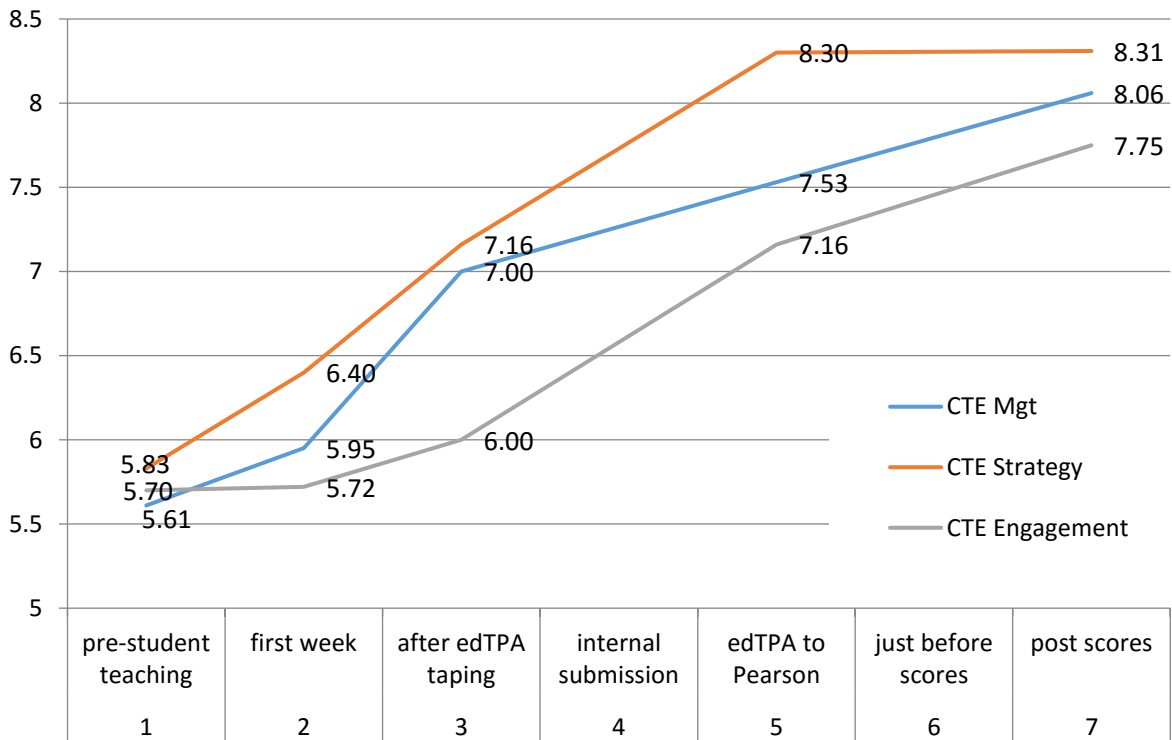

Figure 4. Change in self-efficacy for technology education student teachers in TSES construct areas.

## Objective 2: Correlation Between Self-Efficacy Trends and edTPA Performance

The purpose of determining the correlation between participant self-efficacy trends and edTPA performance is to identify specific steps in the process of completing the edTPA that may impact or be impacted by self-efficacy. Statistically significant correlations were found between self-efficacy and scores of Task 2, Task 3, and the edTPA in its entirety (see Table 4).

Table 4

*Correlations between Self-Efficacy and edTPA Scores for Task 2, 3, and Total for All Student Teachers*

Self-Efficacy at Time...	Task 1	Task 2	Task 3	edTPA Total
T1	.169	.184	.247	.247
T2	.129	.137	.063	.139
T3	-.024	-.200	-.275	-.215
T4	-.538	-.596*	-.201	-.596*
T5	-.369	-.577*	-.513*	-.618**
T6	-.115	-.369	-.312	-.350
T7	-.183	-.457*	-.496*	-.489*

\*( $\alpha = .05$ )

Negative correlations were found between perceived self-efficacy and edTPA performance at various time periods throughout the semester (see Table 4). The “internal submission” (T4), “edTPA to Pearson” (T5), and “post-scores” (T7) benchmarks were all shown to have negative correlations to one or more of the edTPA categories. For this data analysis, negative correlations indicate that the higher the participant’s mean for self-efficacy, the lower they scored on the edTPA. T5 and T7 benchmarks have negative correlations to Task 2, Task 3, and the total edTPA score. T4 benchmark has a negative correlation to Task 2 and the final edTPA score. The strongest correlation was found for the negative correlation between T5 (submission of edTPA to Pearson for official scoring) and the final edTPA score. Negative correlations between these two variables indicate that when self-efficacy means at benchmarks T4, T5, and T7 increase, edTPA scores decreased in Task 2, Task 3, and/or in total edTPA score.

Agricultural education participants were isolated for analysis because they completed all data collection benchmarks. Significant negative correlations were found in T4, T5, and T7 for Task 2 and the total edTPA scores (see Table 5). No significant correlations were found for any benchmark and edTPA Task 1 or 3. Negative correlations were found between variables at T4, T5, and T7. Self-efficacy was most strongly correlated to performance on Task 2 (videoing instruction) and overall edTPA performance at the time of internal submission (T4), submitting the edTPA to Pearson (T5), and after receiving edTPA scores (T7).



Table 5

*Correlations between Self-Efficacy and edTPA Scores on Tasks 2, 3, and Total edTPA for Agriculture Student Teachers.*

Self-Efficacy at Time...	Task 2	Task 3	edTPA Total
T1	-.138	.115	-.033
T2	-.093	.064	-.040
T3	-.396	-.217	-.404
T4	-.596*	-.201	-.596*
T5	-.643*	-.322	-.755*
T6	-.490	-.293	-.562
T7	-.605*	-.545	-.711*

\*( $\alpha = .05$ )

### Conclusions

Based upon research objective 1 of this study, the following conclusions have been made, applicable to the population of participants in this study. The decrease in self-efficacy means after internal submission for Agricultural Education students *may* have occurred because feedback was given to participants at the time of internal submission. Feedback could have caused participants to realize weaknesses in their performance that they were not aware of before. Another possibility is the feedback prompted student teachers to make many changes to their edTPA portfolio before submitting to Pearson. Therefore, burnout could have occurred around this time. This conclusion is supported by data from Technology Education participants' showing that self-efficacy continued to increase around this time. This is likely because these students did not receive feedback. It is not being suggested that internal feedback from university supervisors is a negative or harmful aspect of a program. Feedback can assist in building efficacy (Siwatu & Chesnut, 2014), but may also indicate areas of weakness where student teachers may not have been aware of previously. Therefore, self-efficacy may drop when a student teacher learns of weaknesses through the internal feedback provided by the program supervisor.

Secondly, agricultural education students started with higher perceptions of efficacy than technology students and ended lower than technology education students. Therefore, the conclusion is that student teacher self-efficacy at the beginning of student teaching is not always an accurate predictor of self-efficacy at the end of student teaching. Higher initial feelings of efficacy in these participants may have been influenced by previous mastery experiences during their undergraduate program or through their own teaching practices. This research did not measure previous mastery experiences that may have influenced current efficacy levels at the beginning of the study. Technology education students may have ended with a high self-efficacy mean because they did not experience a significant decrease at any point. Therefore, their self-efficacy continued to rise throughout the semester.

Based upon research objective 2, student teacher self-efficacy at the end of the student teaching semester is negatively correlated with student teacher performance on the edTPA. These results indicate the lower the self-efficacy at the end of the student teaching semester, the higher edTPA is overall. A possible reason for this negative correlation may be associated with the difficulty and rigorous nature of the edTPA. The more intense a student teacher focuses on

the edTPA, the less efficacious they feel after completing both the portfolio and the semester. Having trouble in perfecting the portfolio may cause decreases in feeling of efficacy in the real classroom setting. Student teachers focusing more on the actual classroom teaching experience and less on edTPA will likely experience a lower edTPA score, but a higher self-efficacy in classroom management, instructional strategies, and student engagement.

Self-efficacy is most significantly correlated to Task 2 and the overall total edTPA score. This is likely because Task 2 includes actual teaching demonstration and performance of actual teaching skills. Self-efficacy during Task 2 is most likely to affect the overall edTPA since student teachers are focused on this task's requirements. It takes more mental focus to stand and perform in front of a classroom of students that it does to plan or assess on paper which is required of Task 1 and 3.

Secondly, student teacher performance on the edTPA is negatively correlated with the change in self-efficacy from the beginning to the end of student teaching. These results indicate that the greater the change in self-efficacy from the beginning of the semester to the end, the lower a student performs on the edTPA. This also indicates that when the change in self-efficacy is less, edTPA performance is greater. It is possible the reason for this negative correlation is when students experience a greater change in self-efficacy they were more focused on their actual classroom experience and less focused on the edTPA, resulting in lower edTPA scores. When student teachers focus more on the edTPA portfolio, their efficacy does not increase as much, because it is less influenced by actual hands-on mastery experiences.

Thirdly, internal submission feedback causes student teachers to gain more realistic perceptions of self-efficacy and therefore is most influential of edTPA scores. For agricultural education students, self-efficacy measurements during the second half of a student teaching semester (after internal submission of edTPA to the end of the student teacher semester) can be used to most accurately correlate performance on the overall edTPA. This cannot be concluded for technology students because of missing data in the second part of the semester. Though some statistical analysis used in this study indicated some ability to correlate self-efficacy to Task 2 and Task 3 specifically, it is more applicable to generalize a correlation to the overall total edTPA score.

## **Implications and Recommendations**

The overall conclusions of this study pertain to the effect of feedback on self-efficacy for student teachers throughout the teacher preparation process. The results of this study found giving feedback may result in a lower self-efficacy means. However, overall edTPA scores are higher for participants that receive feedback during the edTPA process.

Conclusion 1 for objective 1 of this study states that feedback given to Agricultural Education after internal submission caused participants to realize weaknesses in performance. Therefore, efficacy dropped after feedback was given. The implication for program leaders is the importance of considering the feedback process during edTPA. The results of this study show timing of the feedback is especially important as it may cause self-efficacy to decrease at a given time. The recommendation is for program leaders to make expectations for the edTPA portfolio

content as clear and concise as possible. Student teachers should be trained to accept and utilize feedback on performance assessments properly in the methods courses. Previous researchers who also recommend providing preservice teachers with specific (Tschannen-Moran, Hoy, & Hoy, 1998), ongoing, and informative feedback (Siwatu & Chesnut, 2014), support this recommendation.

Conclusion 2 of objective 1 for this study states that student teacher self-efficacy at the beginning of student teaching is not always an accurate predictor of self-efficacy at the end of student teaching. Since the participant group ending with high self-efficacy was different than the group that started with the highest self-efficacy, it is concluded that self-efficacy changes during student teaching may be strongly affected by mastery experiences in the preparation program prior to student teaching. It cannot be assumed the group with the highest self-efficacy scores at the beginning of a self-efficacy study will be the higher scoring group at the end. Experiences prior to the study should be considered before comparing the groups out of context. Researchers need to consider prior experiences that may influence current and future self-efficacy scores. Program leaders should consider the impact that mastery experiences have on self-efficacy trends during student teaching.

Negative correlations were a common trend in the data for objective 2. Conclusion 1 of objective 2 states that student teacher self-efficacy at the end of the student teaching semester was negatively correlated with the student teacher performance on the edTPA. The edTPA is a rigorous assessment that may cause some student teachers to feel less efficacious completing both the edTPA portfolio and the semester if they focus heavily on perfecting the edTPA portfolio. Student teachers who put most of their effort into perfecting the edTPA portfolio find it harder to focus on mastering instructional strategies. Student teachers who focus more on classroom instruction will likely feel more capable of managing a classroom and engaging students. However, these students will likely have lower edTPA scores. Program leaders should train student teachers to strive for balance between efficacy-building experiences in their classrooms and edTPA proficiency. Student teachers need to be trained to build efficacy in the actual classroom, while applying their growth and performance in the edTPA style and format. This training is most needed prior to student teaching in methods courses so student teachers are prepared to model this training in student teaching.

Conclusion 2 of objective 2 in this study states that student teacher performance on the edTPA is negatively correlated with the change in self-efficacy from the beginning of student teaching to the end. The greater the change in self-efficacy during student teaching, the lower the edTPA score. Student teachers who focus less on edTPA proficiency are spending more time mastering teaching in the actual classroom. Therefore, mastery experiences are just as impactful to the overall efficacy as the pressure of the edTPA on student teachers. In addition to previously recommended training, student teachers should be trained to balance classroom instructional involvement and completing the edTPA. Professional development or methods lessons on time management or balancing student teaching requirements may provide specific training for student teachers to address this imbalance. As a result, student teachers should be better able to manage mastery experiences in their classroom and proficiency on the edTPA.

Conclusion 3 of objective 2 in this study states that feedback after internal submission causes student teachers to gain a more realistic perception of self-efficacy. Therefore, self-efficacy measurements at time when feedback is given can be a good predictor of edTPA performance. These measurements of self-efficacy most accurately correlate to the overall edTPA score. To gain most accurate self-efficacy measurements, student teachers should be provided constant feedback throughout the learning process. They should also be trained to properly apply feedback to their future performance. Practice with utilizing feedback prior to student teaching is emphasized again as the main recommendation for program leaders in preparing student teachers for edTPA proficiency and efficacy growth.

### **Recommendations for Future Research**

As the edTPA becomes the preferred teacher preparation assessment for teacher preparation programs, the need to build upon this study exists. Other researchers for continuation of improved edTPA implementation (Lunsford, 2016) have recommended continuation of research on the agricultural education teacher preparation program at North Carolina State University. The methods of this study can be replicated or modified for further investigation of the relationship between student teacher self-efficacy and edTPA performance. It is recommended for replication of this study in many other teacher preparation programs implementing the edTPA as their teacher candidate performance assessment. Comparisons should be made between programs' implementation strategies and effects on student teacher efficacy. Specific research questions for beneficial future research include:

- (1) How does feedback from program leaders affect student teacher self-efficacy and performance on the edTPA?
- (2) What is the relationship between self-efficacy during methods courses (prior to student teaching) and performance on the edTPA?
- (3) What is the difference between student teachers who receive feedback on edTPA during student teaching and student teachers who do not?

Many teacher preparation programs that implement edTPA carry out focus group interviews after the program to obtain feedback on student teacher perception of the edTPA and the student teaching experience in general. It is highly recommended that focus group interviews continue to be utilized to obtain qualitative data that can be used in comparison to the quantitative data such as in this study. Qualitative and quantitative data such as this will provide valuable information leading to conclusions for further improvement of edTPA implementation. By replicating this study in programs across the country, more generalized conclusions can be presented for application in more programs.

## References

- American Association of Colleges for Teacher Education. (2017). *About edTPA*. Retrieved from <http://edtpa.aacte.org/about-edtpa>
- American Federation of Teachers. (2012). *Raising the bar: Aligning and elevating teacher preparation and the teaching profession*. Retrieved from <http://uupinfo.org/committees/pdf/teached/AFTReports/RaisingTheBar2012.pdf>
- Bandura, A. (1994). Self-efficacy. In V.S. Ramachaudran, *Encyclopedia of Human Behavior*, 4, 71-81.
- Bandura, A. (1997). *Self-efficacy: The exercise of control*. New York: Macmillan.
- Caprara, G. V., & Malone, P. S. (2006). Teachers' self-efficacy beliefs as determinants of job satisfaction and students' academic achievement: A study at the school level. *Journal of School Psychology*, 44(6), 473-490. doi:10.1016/j.jsp.2006.09.001
- Darling-Hammond, L. (2012). *Powerful teacher education: Lessons from exemplary programs*. San Francisco, CA: John Wiley & Sons.
- Every Student Succeeds Act (ESSA). (2015). Retrieved from U.S Department of Education: <https://www.ed.gov/essa?src=rn>
- Friedman, I. A., & Kass, E. (2002). Teacher self-efficacy: A classroom-organization conceptualization. *Teaching and Teacher Education*, 18(6), 675-686.
- Gordon, C., & Debus, R. (2002). Developing deep learning approaches and personal teaching efficacy within a preservice teacher education context. *British Journal of Educational Psychology*, 72(4), 483-511. Doi: 10.1348/00070990260377488
- Klassen, R. M., & Chiu, M. M. (2010). Effects on teachers' self-efficacy and job satisfaction: Teacher gender, years of experience, and job stress. *Journal of Educational Psychology*, 102(3), 741. doi: 10.1037/a0019237
- Krejcie, R. V., & Morgan, D. W. (1970). Determining sample size for research activities. *Educational and Psychological Measurement*, 30(3), 607-610.
- Lunsford, A. R. (2015). *Examining the benefits and barriers of edTPA on agricultural education students at North Carolina State University* (Unpublished master's thesis). North Carolina State University, Raleigh, NC
- Siwatu, K. O., & Chesnut, S. R. (2014). The career development of preservice and inservice teachers: Why teachers' self-efficacy beliefs matter. In H. Fives & M. Gill (Eds.), *International handbook of research on teachers' beliefs* (pp. 212-229). New York, NY: Routledge.

- Miller, M., Carroll, D., Jancic, M., & Markworth, K. (2015). Developing a culture of learning around the edTPA: One university's journey. *The New Educator, 11*(1), 37-59.
- Myers, B. E., & Dyer, J. E. (2004). Agriculture teacher education programs: A synthesis of the literature. *Journal of Agricultural Education, 45*(3), 44-52. doi: 10.5032/jae.2004.03044
- Sato, M. (2014). What is the underlying conception of teaching of the edTPA? *Journal of Teacher Education, 65*(5), 421-434.
- Stanford Center for Assessment, Learning, and Equity. (2014). *edTPA Support and Assessment: State Policies and Educator Preparation Program Implementation Support Dashboard*. Palo Alto: Author.
- Tschannen-Moran, M., & Woolfolk Hoy, A. (2001). Teacher efficacy: Capturing an elusive construct. *Teaching and Teacher Education, 17*, 783-805. doi10.1016/S0742-051X(01)00036-1
- Tschannen-Moran, M., Hoy, A. W., & Hoy, W. K. (1998). Teacher efficacy: Its meaning and measure. *Review of Educational Research, 68*(2), 202-248.
- United States Department of Labor, Bureau of Labor Statistics (2015). Occupational outlook handbook: High school teachers. Retrieved from <https://www.bls.gov/ooh/education-training-and-library/high-school-teachers.htm>
- Wheeler, J. & Knobloch, N. A. (2006). *Relationship of teacher and program variables to beginning agriculture teachers' sense of efficacy*. Paper presented at the 33<sup>rd</sup> National Agricultural Education Research Conference, Charlotte, NC.
- Whittaker, A., & Nelson, C. (2013). Assessment with an "End in View." *The New Educator, 9*(1), 77-93. doi: 10.1080/1547688X.2013.751315

# Demographic Characteristics of Students in Secondary Agricultural Education Programs

Sarah A. Bush, Virginia Tech  
Stephen W. Edwards, University of Mount Olive  
Curtis R. Friedel, Virginia Tech

## Abstract

Agricultural education must attract diverse students to respond to an influx of agricultural jobs and solve complex global challenges. From the year 2000 to date, only eight national studies and 25 regional studies have reported demographics of students within agricultural classrooms. These previous studies provide a glimpse into the demographics and backgrounds of students, but do not provide a full picture. Therefore, this study aims to provide a demographic snapshot of students enrolled in agriculture education, and examine relationships between student demographic information and their FFA enrollment, and SAE activities. Data were collected in a nationwide study and included 2,106 participants from 152 agricultural education programs in 11 states, representing geographical regions of the United States. The results yielded a homogeneous group of participants and significant relationships between select demographics and FFA involvement and SAE participation. Scholars and educators should consider the role of inclusion and strategies for recruiting diverse students in agricultural education programs.

## Introduction

Who are the students enrolled in secondary agricultural education programs across the country? In 2016, the White House released the following statement indicating a need to increase diversity of people in the agriculture industry: “agricultural education needs to attract a diversity of students and keep pace with the increasingly complex nature of agricultural innovation needed to address global challenges” (para. 2; The White House, 2016). As it turns out, little scientific evidence exists regarding the demographic information of students enrolled in secondary agricultural education programs. Some generalizable information exists regarding demographics of agricultural education students who also joined the FFA youth organization (e.g. Balschweid & Talbert, 2000; Lawrence, Rayfield, Moore, & Outley, 2013; Talbert & Balschweid, 2006). However, it was estimated that nearly 40% of students enrolled in agricultural education choose not to join FFA (Lawrence et al., 2013; Talbert & Balschweid, 2004). Simply asked, how do we increase the diversity of people in the agriculture industry if we don’t know baseline demographic information of students enrolled in secondary agricultural education?

Determining the demographic information of students enrolled in agricultural education programs across the country was deemed crucial for at least three reasons. Firstly, curriculum planners at the state and national levels require knowledge of current and potential student demographic information for projecting enrollments in educational programs (Finch & Crunkilton, 1999). Secondly, the agricultural industry now depends on employees from diverse cultural, economic, and ethnic backgrounds; but many individuals in these groups have misconceptions of agriculture as a potential career (National Research Council, 2009). Despite efforts and multimillion dollar investments from the government, these populations remain underrepresented within the agricultural industry (The White House, 2016). Thirdly,

demographic information of secondary agricultural education students is required to develop baseline models for higher-level statistical analysis, such as propensity score matching (Rojewski, Lee, & Gemici, 2010) for future studies. Several researchers have examined the motivations and interests of students considering careers in agriculture as well as individuals with influence on these students' decisions (e.g. Esters, 2007). Agodini, Uhl, and Novak (2004) found evidence of a relationship between demographic factors and the decision to participate in vocational education. If there is a relationship between demographic characteristics and entry into an agricultural career, more research is needed to identify the associated salient variables.

### **Purpose and Objectives**

Do the demographic characteristics associated with students enrolled in agricultural education programs across the U.S. explain their involvement in the FFA organization and supervised agricultural experience (SAE) activities? The purpose of this study was to examine the demographic characteristics of students enrolled in agricultural education programs in the U.S., and determine if student demographic variables explain involvement in FFA and SAE activities.

The specific objectives of the study are:

1. Determine selected demographic information of students enrolled in secondary agricultural education programs.
2. Examine relationships between demographics of secondary agricultural education students and involvement in the FFA organization.
3. Examine relationships between demographics of secondary agricultural education students and involvement in SAE activities.

### **Literature Review**

Krumboltz, Mitchell, and Jones (1976) proposed the social learning theory of career selection to explain how individuals choose educational programs and career preferences throughout life. According to their theory, career placement is a result of four interacting forces: genetic components of the individual, which not only includes individual characteristics (such as appearance), but also physical and intellectual abilities; environmental conditions which includes variables associated with social, cultural, and economic factors, as well as geographic location; learning experiences which includes active and observational learning; and task approach skills which includes the mental approaches and emotional responses to making decisions (Krumboltz et al., 1976). These influencers result in a lifelong process of career-decision making with social events and individual decisions coalescing to form an infinite number of career selection possibilities (Krumboltz et al., 1976). Indeed, the process of career selection may be complex and difficult to predict; but in theory, demographic characteristics of an individual may play a vital role in deciding to enroll in educational programs and pursuing particular occupations.

Esters and Bowen (2005) found partial support for the social learning theory of career selection in a study that examined the career pursuits of urban agricultural education students. Participants who chose a career in agriculture reported career opportunities, high school educational experiences, and work experiences as the reasons for their choice (Esters & Bowen, 2005). However, those who did not choose a career in agriculture placed other career interests, a



lack of interest in the industry, a lack of opportunities, and personal factors as their reasons. The responses provide a glimpse into how interactions of genetic factors, environmental conditions, learning experiences, and performance skills impact one's career selection.

Agricultural education is based around contextual learning, work-based learning, and student leadership opportunities (National FFA Organization, 2015). These components are achieved through participation in the classroom, FFA, and SAE projects. The absence of one of these elements can result in reduced leadership, personal growth, and career success (National FFA Organization, 2015). With high school educational and work experiences being primary reasons for students choosing to pursue a career within agriculture, involvement within FFA and SAE activities act as influencers for career aspirations and success within agricultural industries.

To establish current knowledge on the demographics of secondary agricultural education students, a review of published research involving the demographics of secondary students in agricultural education was conducted between the years 2000 and 2017 in the following journals: *Career & Technical Education Research (CTER)*, *Journal of Agricultural Education (JAE)*, *Journal of Leadership Education (JOLE)*, and the *Journal of Southern Agricultural Education Research (JSAER)*. While the subsequently identified studies may not have been interested in identifying demographic information of students enrolled in agricultural education per se, these studies do provide this information for the purpose of offering a backdrop to this study.

Eight studies with national approaches were retrieved within the search and are represented in Table 1. Of the articles, the largest national approaches were conducted by Balschweid and Talbert (2000), Talbert and Balschweid (2004/2006) and Lawrence et al. (2013). Two of the studies (Balschweid & Talbert, 2000; Talbert & Balschweid, 2006) involved FFA members enrolled in secondary agricultural education courses. Both studies reported FFA members' ethnicity, gender, age, FFA involvement of parents and siblings, 4-H membership, living area, household size, family income, self-reported GPA, and future educational aspirations. Talbert and Balschweid (2004) differed from the other two studies as it was a national comparison study between FFA members and non-members. The demographics reported in this study included FFA/4-H/agricultural education involvement of parents and siblings, living area, 4-H involvement, and SAE participation.

Lawrence et al. (2013) aimed to describe the demographics of FFA members according to population density. This study recruited a total of 128 FFA chapters utilizing a stratified random sample. This sampling method allowed the researchers to achieve equal representation of population density (rural, suburban, and urban) within each of the four regional areas (central, eastern, southern, and western). According to population density, Lawrence et al. (2013) were able to describe gender and ethnicity of FFA chapter members in comparison with their respective schools and communities, at large. Additionally, this study provided insight into FFA membership according to population density. The study reported 71.25% of rural agricultural education students, 68.27% of suburban agricultural education students, and 52.27% of urban agricultural education students are FFA members (Lawrence et al., 2013). The national total was reported as 62.25% of agricultural education students involved in FFA (Lawrence et al., 2013). These percentages demonstrate a decline in membership according to population density.

Five national studies reported demographic variables of agricultural education students. Horstmeier and Nall (2007) focused on FFA members who lived in rural areas. Demographics reported for the rural FFA members included gender, ethnicity, grade level, years of FFA membership, and chapter officer participation. Because all students in the study were from rural areas, area of residence was not reported. Croom et al. (2009) focused on career development event (CDE) participants at the 2003 National FFA Convention. The reported demographics included gender, ethnicity, grade level, and years of FFA membership. Rayfield et al. (2007) focused on one particular FFA CDE, Livestock Evaluation. The reported demographics from this study included gender, judging experience, chapter size, number of high school agriculture teachers and residency. Thoron and Myers (2011; 2012) conducted a study with agriscience students, which described the ethnicity, grade, socioeconomic status, and gender of participants.

Table 1

*National Studies that Report Secondary Student Demographics in Agricultural Education*

<i>Study</i>	<i>National Focus</i>	<i>Demographics Reported</i>
Balschweid & Talbert (2000)	FFA Members	Ethnicity, Gender, Age, Parents/Siblings in Ag Ed, 4-H Membership, Residency, Household Size, Family Income, GPA, Educational Aspirations
Croom, Moore, & Armbruster (2009)	FFA CDE Participants	Gender, Ethnicity, Grade, Years of FFA Membership
Horstmeier & Nall (2007)	Rural FFA Members	Gender, Ethnicity, Grade, Years of FFA Membership, Chapter Office Participation
Lawrence, Rayfield, Moore, & Outley (2013)	FFA Chapter Demographics	Living Area, Gender, Ethnicity, FFA Membership, School Demographics, Community Demographics, and Teacher Demographics
Rayfield, Frazee, Brashears, & Lawver (2007)	FFA Livestock Evaluation CDE Participants	Gender, Judging Experiences, Chapter Size, Number of Agriculture Teachers, Residency
Talbert & Balschweid (2004)	FFA Members vs. Non-Members Comparison	FFA/4-H/Ag Ed involvement of parents and siblings, living area, 4-H involvement, and SAE participation
Talbert & Balschweid (2006)	FFA Members	Ethnicity, Gender, Age, Parents/Siblings in Ag Ed, 4-H Membership, Residency, Household Size, Family Income, GPA, Educational Aspirations
Thoron & Myers (2011; 2012)	Agriscience Students	Ethnicity, Grade, Socio-economic Status, Gender

*Note.* Articles date back to 2000 and were retrieved from: *CTER*, *JAE*, *JOLE*, and *JSAER*.

The results from these National studies provides some insight into the demographics of students within agricultural education courses, FFA, and agriscience students. Based upon these studies, it appears the number of males and females within agricultural education are fairly even. However, all of the studies reported samples, which are predominately white/Caucasian. The reported demographics from the National studies are represented in Table 2.

Table 2  
*Reported Demographics in Age, Grade Level, Ethnicity, and Gender in Agricultural Education National Studies from 2000 to current*

<i>Study</i>	<i>Age/Grade</i>	<i>%</i>	<i>Ethnicity</i>	<i>%</i>	<i>Gender</i>	<i>%</i>
Balschweid & Talbert (2000)	≤ 14	4.5	White	94.0	Male	56.4
	15	18.2	Hispanic	1.8	Female	43.6
	16	23.2	Multiracial/Other	1.4		
	17	20.5	Black	1.8		
	18	20.4	Native American	0.5		
	> 18	13.2	Asian	0.5		
Croom et al. (2009)	Junior/Senior	61.8	Caucasian	92.2	Male	48.4
	Other	38.2	Native American	1.6	Female	48.5
			Other	6.2	Unreported	3.1
Horstmeier & Nall (2007)	Middle Sch.	7.90	White, Non-Hispanic	83.63	Male	54.86
	Freshmen	30.93	Black, Non-Hispanic	5.07	Female	45.14
	Sophomore	25.53	Hispanic	5.07		
	Junior	19.59	Asian	2.40		
	Senior	16.16	Other	2.94		
Lawrence et al. (2013)			White	80.41	Male	54.95
			Asian/Pac Islander	0.63	Female	45.05
			Black	4.13		
			Hispanic	12.51		
			Native American	2.19		
Rayfield et al. (2007)	N/A		Other	0.14		
			N/A		Male	50.3
Talbert & Balschweid (2004)					Female	49.7
					N/A	
Talbert & Balschweid (2006)	≤ 14	6.7	White	92.0	Male	46.2
	15	20.2	Hispanic	2.4	Female	53.8
	16	24.4	Multiracial	2.2		
	17	22.0	Black	1.5		
	18	14.5	Native American	1.4		
	> 18	12.2	Asian	0.5		
Thoron & Myers	Freshman	48.5	White, Non-Hispanic	81.6	Male	58.5
	Sophomore	44.0	Black	4.3	Female	41.5

(2011; 2012)	Junior Senior	7.5 0	Hispanic Other	10.2 3.9
-----------------	------------------	----------	-------------------	-------------

*Note.* Demographics displayed were the most commonly reported demographic variables.

Besides national studies, several regional studies reported the demographics of secondary agricultural students. All of the regional studies with one exception are confined to a single state. Demographics reported in multiple studies include Gender ( $n = 22$ ), Ethnicity ( $n = 17$ ), Grade Level ( $n = 17$ ), Age ( $n = 9$ ), Free/Reduced Lunch/Socio-economic Status ( $n = 6$ ), Residence ( $n = 5$ ), and GPA/Grade Average ( $n = 4$ ). Some other demographic variables were reported, but did not appear in more than two studies. Table 3 shares the demographics reported in each of the regional studies. Although several studies display demographics of secondary agricultural education students, this national study focused on all agricultural students is needed to develop an accurate picture of the students enrolled in agricultural education classrooms.

Table 3  
*Regional Studies that Report Secondary Student Demographics in Agricultural Education*

Study	Location	Demographics Reported
Ahrens, Cox, Burris, & Dykes (2015)	Arkansas	Gender, Ethnicity, Years in FFA, Age, Grade
Brown, Terry, & Kelsey (2013)	Oklahoma	Gender, Race, Age, Grade, Socio-economic Status, Chapter FFA Officer, GPA
Bunch, Robinson, Edwards, & Antonenko (2014)	Oklahoma	Gender, Age, Race/Ethnicity, Grade, Number of Ag Ed Courses, SAE
Burris & Garton (2006)	Missouri	Gender, Grade
Croom & Flowers (2001a)	North Carolina	Gender, Ethnicity
Croom & Flowers (2001b)	North Carolina	Gender, Ethnicity, Grade, FFA Membership, Club Participation
De Lay & Swan (2014)	California	Gender, Ethnicity, Grade
Haynes, Robinson, Edwards, & Key (2012)	Oklahoma	Socio-economic Status
Horstmeier (2006)	Southern Region	Gender, Ethnicity, Grade, Year of FFA Membership, Chapter Office Participation
Israel, Myers, Lamm, & Galindo-Gonzalez (2012)	Florida	Age, Gender, Race-ethnicity, Primary Language Spoken at Home
Martin & Kitchel (2014)	Midwestern Metropolitan	Race, Gender, Grade
Park & Osborne (2007)	Florida	Gender, Grade, Ethnicity, Free/Reduced Lunch, GPA
Peake, Briers, & Murphy (2005)	Texas	Gender, Ethnicity, Free/Reduced Lunch, English Proficiency, Special Education, Gifted & Talented
Phelps, Henry, & Bird (2012)	Illinois	Gender, Ethnicity, Grade, Residence
Reidel, Wilson, Flowers, & Moore (2007)	Unspecified	Gender, Ethnicity, Residence, Grade, Prior Agriculture Experience
Ricketts, Priest, & Lastly (2007)	Georgia	Age, Gender, Living Area
Rohs, Anderson, & Iverson (2002)	Georgia	Gender, Grade, Residence, Ethnicity
Scott & Lavergne (2004)	Arkansas	Ethnicity, Age, Residence, Parent Education Level, Future Employment
Swortzel, Jackson, Taylor, & Deeds (2003)	Mississippi	Gender, Grade, Ethnicity
Thoron & Myers (2011)	Florida	Gender, Ethnicity, Free/Reduced Lunch, Grade

Ulrich, Pavelock, Muller, & Harrell (2005)	Texas	Gender, Age, Ethnicity
Witt, Doerfert, Ulmer, Burris, & Lan (2013)	Texas	Gender
Wyatt, Shoulders, & Myers (2015)	Unspecified State	Grade, Free/Reduced Lunch, FFA Membership, Number of Ag Classes
Young, Edwards, & Leising (2008)	Oklahoma	Gender, Grade, Age, Ethnicity, Grade Average
Young, Hodge, Edwards, & Leising (2012)	Oklahoma	Gender, Ethnicity, Age, Grade, Grade Average

*Note.* Articles date back to 2000 and were retrieved from: *CTER*, *JAE*, *JOLE*, and *JSAER*.

## Methods

To accomplish the objectives of this study, the researchers secured data from a national study (Friedel, Ricketts, Rhoades, Irani, & Stedman, 2009), which included 2,106 student responses (76% response rate) enrolled at 152 secondary agricultural education programs randomly selected within eleven states identified regionally throughout the United States.

### Participants and Data Collection

The participants in this study were secondary agricultural students from 11 states, including: California, Florida, Georgia, Idaho, Iowa, Louisiana, New York, North Carolina, Ohio, Texas, and Virginia. From each state 20 agricultural education programs were randomly selected. However, due to lack of response, one state was only able to recruit 12 agricultural education programs. Of the 212 programs selected, 152 programs participated. The study sample consisted of 2,770 students with a total of 2,112 (76%) respondents, with six students being removed from the sample due to lack of consistent response. Sample size for statistical tests was adjusted by omitting non-item response variables to incorporate a total of 1,059 students to continue with data analysis for this study (Altman & Bland, 2007). This sample size coincides with Dillman, Smyth, and Christian's (2009) recommendations for sampling coverage.

To begin data collection, a university professor was contacted from each state to randomly select 20 high school agricultural education programs within their respective state. Programs were randomly selected utilizing a random number generator. Agricultural educators for the randomly selected programs were asked to participate in the survey via phone or email. In the case of programs with multiple instructors, the most senior educator was asked to participate. Programs with agricultural educators with less than one year of experience were not included within the sample. If a school declined, another school was randomly selected until 20 programs agreed to participate (Friedel et al., 2009). The university professor in each state was then asked to randomly assign each agricultural education program a class based on the number of freshmen, sophomores, juniors, and seniors found in the class. For example, the first educator to respond may have been asked to utilize a class with mostly freshmen and the second educator was assigned a class with mostly sophomores, etc. This technique aided in collecting a data sample with a variety of class standings. Additionally, it hindered agricultural educators from choosing their "best" class to participate in the study. The cross-sectional data were collected during one class period of the selected class.

### Instrumentation

Demographic data were collected via two instruments administered to the students: the Agricultural Student Engagement Survey (ASES) and the High School Survey of Student Engagement (HSSSE). The ASES was utilized by Friedel et al. (2009) to measure student engagement, involvement in specific FFA and SAE activities, as well as demographic information pertaining to: gender, self-reported GPA, years enrolled in agricultural education, and whether or not they were living on a farm. The HSSSE is a biannual survey measuring student engagement among more than 40,000 secondary students (Yazzie-Mintz, 2010). It was administered concurrently with the ASES and includes the following demographic information: age, ethnicity, grade level, eligibility for free or reduced-price lunch, if English was a primary language at home, and education level of parents/guardians.

### **Data Analysis Procedures**

To meet the first objective, descriptive statistics used to analyze FFA involvement, SAE activities, self-reported GPA, years enrolled in agricultural program, whether the student is living on a farm or not, age, gender, race, grade level, eligibility for free or reduced lunch, if English is the primary language at home and the educational level of parents/guardians. To determine the relationships between demographics of secondary agricultural education students and their involvement in the FFA organization, a binomial logit generalized linear mixed model (GLMM) was utilized. An alpha level of 0.05 was set a priori.

A GLMM model was utilized to avoid falsely increasing statistical significance and avoid biased standard errors (Gbur et al., 2012). GLMMs include both fixed and random effects to account for clusters within states and classrooms (Agresti & Natarajan, 2001; Hedeker, 2005). GLMM are commonly utilized with dichotomous and categorical variables (de Leeuw, Meijer, & Goldstein, 2008). To determine the relationships between demographics of secondary agricultural education students and their involvement in SAE activities a multinomial logit GLMM model was utilized. Within a multinomial model, a baseline category is utilized as a reference category (Bayaga, 2010). Within this analysis, a collection of dummy variables were created to represent different categories (Hosmer & Lemeshow, 2000). The baseline variable utilized was the indication of no SAE activity.

## **Results**

### **Objective 1: Demographic Information of Secondary Agricultural Education Students**

Respondents consisted of 81.9% FFA members ( $n = 867$ ). The mean age was 16.34 ( $SD = 1.24$ ). The average overall GPA was 3.29 ( $SD = 2.82$ ). The participants consisted of more juniors than other grade levels (31.7%,  $n = 336$ ). However, members were relatively evenly distributed between freshmen (24.6%,  $n = 261$ ), sophomore (20.1%,  $n = 213$ ), junior, and seniors (23.5%,  $n = 249$ ). English was the primary language spoken at home (95.2%,  $n = 1008$ ). Only 30.1% of participants lived on a farm ( $n = 319$ ). The majority of respondents did not receive a free or reduced lunch (55.8%,  $n = 591$ ). The highest frequency of education parents was attainment of a high school diploma or GED equivalent (30.8%,  $n = 326$ ). Over 70% of participants were White (73.7%,  $n = 780$ ) with multiracial (6.1%,  $n = 65$ ) and Latino (6.1%,  $n = 65$ ) being the second largest reported races. On average participants had been enrolled for 2.04 years ( $SD = 1.123$ ).

Table 4

*Means, Standard Deviations, Frequencies, and Percentages for demographics of Agricultural Education Students (n=1,059)*

Characteristic	Min	Max	M	SD
GPA	.09	4.0	3.29	2.82
Age	14	20	16.34	1.24
Years Enrolled	0	4	2.04	1.12

Characteristic	f	%	Characteristic	f	%
FFA Membership			Live on a farm		
Yes	867	81.9	Yes	319	30.1
No	192	18.1	No	740	69.9
Gender			Parent/Guardian		
Male	607	57.3	Don't know/Not	97	9.2
Female	452	42.7	Did not finish HS	59	5.6
Grade Level			High School	326	30.8
Freshman	261	24.6	Two-year college	197	18.6
Sophomore	213	20.1	Four-year college	213	20.1
Junior	336	31.7	Master's degree	129	12.2
Senior	249	23.5	Doctorate/Advance	38	3.6
English Primary			Race/Ethnicity		
Yes	1008	95.2	White	780	73.7
No	51	4.8	Latino/Hispanic	65	6.1
Free/Reduced Lunch			Black	36	3.4
No	591	55.8	Native American	43	4.1
Yes	297	28.0	Asian/Middle	14	1.3
Don't know/prefer	171	16.1	Multiracial	65	6.1
			Prefer not share	56	5.3

*Note.* Information self-reported through the ASES and HSSSE surveys.

### Objective 2: Predicting FFA Participation

A binomial logit GLMM was performed to ascertain the effects of gender age, GPA, grade level, years enrolled in agricultural education, living on a farm, English as a primary language, free/reduced lunch, parent/guardian education, and race/ethnicity on the likelihood of FFA membership for secondary agricultural education students. The binomial logit GLMM was statistically significant,  $F(24) = 3.678, p < .05$ . Increasing in GPA was associated with a decrease in the likelihood of FFA participation. However, for a one-unit increase in the years enrolled in agricultural education students were .699 times ( $se = .107$ ) more likely to participant in FFA. Students who lived on a farm were 1.159 times ( $se = .265$ ) more likely to be FFA members.

Table 5

*Summary of Binary Logistic Regression for Variables Predicting FFA Membership and Non-FFA Membership (n = 1,059)*

Predictor	F (df)	$\beta$	se
Corrected Model	3.678* (24)		

Gender	0.273 (1)	-.096	.185
Age	0.080 (1)	.041	.146
GPA	6.836* (1)	-.011*	.004
Grade Level (Freshman)	1.288 (3)		
Sophomore		-.537	.298
Junior		-.679	.395
Senior		-.695	.530
Years Enrolled	42.572* (1)	.699*	.107
Live on a farm	19.176* (1)	1.159*	.265
English Primary	.017 (1)	.059	.456
Free/Reduced Lunch (No)	.047 (2)		
Yes		.059	.211
Don't know/prefer not to answer		.051	.255
Parent/Guardian Education (Not Applicable)	0.719 (6)		
Did not complete high school		-.113	.433
High School Diploma/GED		.353	.311
Two-year college degree		.303	.336
Four-year college degree		.476	.333
Master's degree		.518	.369
Doctorate/Advanced Professional		.267	.519
Race/Ethnicity (White)	0.712 (7)		
Latino/Hispanic		-.020	.472
Black		-.916	.784
Native American		-.123	.445
Asian/Middle Eastern		.404	.455
Multiracial		-.393	.361
Prefer not to respond		.362	.368

*Note.* Female, freshman, not living on a farm, no response to English as the primary language, not receiving free/reduced lunch, unknown parental education, and white served as the reference groups, respectively. \* $p < .05$ .

### **Objective 3: Predicting SAE Projects**

A multinomial logit GLMM was conducted to examine the impacts of gender, age, GPA, grade level, years enrolled in agricultural education, living on a farm, English as a primary language, free/reduced lunch, parent/guardian education, and race/ethnicity on the likelihood of participation in Entrepreneurship, Placement, Research, Exploratory, Other, and Multiple SAE projects. The logit GLMM was statistically significant,  $F(144) = 2.120^*$ ,  $p < .05$ . For entrepreneurship, years enrolled ( $\beta = .442$ ,  $se = .096$ ), living on a farm ( $\beta = .832$ ,  $se = .191$ ), and being multiracial ( $\beta = .923$ ,  $se = .438$ ) were associated with an increase in likelihood of participation. The likelihood of participating in a placement SAE was increased based on years enrolled ( $\beta = .781$ ,  $se = .193$ ), living on a farm ( $\beta = .678$ ,  $se = .193$ ), and parental education. Additionally, seniors were 1.201 ( $se = .546$ ) less likely to participate in placement SAEs. Females were .541 ( $se = .192$ ) times more likely to participate in an exploratory SAE. Those without English as their primary language ( $\beta = -1.399$ ,  $se = .503$ ) and Asian/Middle Eastern ( $\beta = -1.716$ ,  $se = .660$ ) were less likely to report their SAE in an “other” category. With a GPA



increase of one-unit, participants were .022 ( $se = .010$ ) times less likely to participate in multiple SAE projects. However, years enrolled ( $\beta = .694, se = .152$ ), living on a farm ( $\beta = 1.041, se = .266$ ), not reporting free or reduced lunch ( $\beta = .759, se = .323$ ), and parents having a four-year degree ( $\beta = 1.158, se = .548$ ) or an advanced degree ( $\beta = 1.976, se = .707$ ) increased the likelihood for participants to have multiple SAE projects. All results can be viewed in Table 6.

## Conclusions and Discussion

Examining demographics and backgrounds of secondary agricultural education students, at the national level, allows state and national curriculum planners to project enrollment (Finch & Crunkilton, 1999), provides insight into diversification of the agricultural industry (National Research Council, 2009), and establishes baseline models for higher-level statistical analysis (Rojewski et al., 2010). A thorough literature review of publications examining demographic information of secondary agricultural education students within the past 17 years yielded eight national studies and 25 regional studies. While past studies provide a starting point for understanding demographics, it is the hope of the authors that this study provides a baseline of demographic reporting for which future studies may use for comparison, as well as provide a model for which higher-level statistical analysis may be used for predictive purposes.

One of the interesting findings within this study was the impact living on a farm has on a student's likelihood to participate in FFA and specific SAE projects. Of all agricultural education students within this study, only 30.1% of students reported living on a farm. However, those students were 1.159 times more likely to be FFA members than participants who did not live on a farm. These students are more likely to partake in entrepreneurship, placement, and multiple SAE projects. This could be based on a wider understanding of the agricultural industry and parental influence. These students understand what a career within agriculture looks like and are able to vision themselves within those positions; and thus see value in FFA and specific SAEs allowing them to practice skills in the industry (Krumboltz et al., 1976).

Students participating in this study self-reported relatively homogeneous demographics, which is consistent with the previous national studies, indicating a low level of diversity within agricultural education programs (i.e. Balschweid & Talbert, 2000; Lawrence et al., 2013; Talbert & Balschweid, 2004/2006). Conversely, to address complex global issues agricultural education needs to recruit a diverse group of students (The White House, 2016). The diversification of agricultural education classrooms could lead to a more diverse workforce in the agriculture industry. Parental and guardian influence on the choice of a career within agriculture should be considered as a starting point (Esters & Bowen, 2005). Media may also have an impact on perceptions of agriculture for both influencers and the students themselves (Lundy et al., 2007). Therefore, providing marketing campaigns for education on the agricultural industry may decrease falsified stereotypes and encourage youth to see their futures within a variety of agricultural positions of employment. Additionally, agricultural instructors should examine possible obstacles impeding students' participation in FFA and specific SAE projects to ensure all agricultural education students are provided opportunity to explore various career paths so that they may become successful contributors to the progress of feeding, clothing, and providing sustainable energy to the world.

Table 6

*Summary of Multinomial Logistic Regression for Variables Predicting SAE Participation for Entrepreneurship, Placement, Research, Exploratory, Other, and Multiple Projects (n = 1,059)*

Predictor	F (df)	Entre		Placement		Research		Exploratory		Other		Multiple	
		$\beta$	se	$\beta$	se	$\beta$	se	$\beta$	se	$\beta$	Se	$\beta$	se
Corrected Model	2.120* (144)												
Gender	2.832* (6)	.025	.164	-.105	.177	-.338	.300	-.541*	.192	0.388	.235	-.316	.246
Age	0.632 (6)	.018	.133	.071	.145	-.090	.236	-.198	.159	-.126	.182	.142	.206
GPA	1.521 (6)	-.008	.005	-.004	.005	.000	.006	-.007	.005	.001	.005	-.022*	.010
Grade Level	1.647* (18)												
Sophomore		-.250	.279	-.471	.309	.786	.505	-.028	.321	.084	.359	-.595	.462
Junior		.165	.373	-.459	.411	.910	.660	.215	.438	-.150	.516	-.050	.602
Senior		-.541	.498	-1.201*	.546	-.478	.930	.390	.568	-.421	.670	-.595	.781
Years Enrolled	11.258* (6)	.442*	.096	.781*	.193	.176	.297	.108	.109	.178	.136	.694*	.152
Live on a farm	5.383* (6)	.832*	.191	.678*	-.193	.423	.420	.189	.244	.177	.270	1.041*	.266
English Primary	2.266 (6)	-.288	.375	-.846	.376	-.577	.553	.321	.470	-1.399*	.503	-.463	.629
Free/Reduced Lunch	1.077 (12)												
Yes		-.316	.194	-.226	.209	-.266	.343	-.165	.223	-.023	.263	.278	.292
Don't know/prefer not		.216	.224	.205	.245	-.318	.462	.167	.265	-.022	.318	.759*	.323
Parent/Guardian Education	1.239 (36)												
Did not complete high		.101	.391	.249	.448	.267	.654	-.108	.460	-.327	.617	-1.406	1.145
High School		.140	.293	.721*	.339	.385	.508	.114	.341	.028	.405	.531	.535
Two-year college degree		.352	.313	.543	.371	.438	.552	-.018	.381	.244	.436	.611	.568
Four-year college degree		.421	.311	.670	.368	-.667	.688	.411	.363	.659	.414	1.158*	.548
Master's degree		.507	.356	.950*	.392	.184	.613	.292	.402	.572	.449	1.099	.593
Doctorate/Advanced Pro		.725	.507	.262	.684	-.088	1.147	.564	.591	1.196	.622	1.976*	.707
Race/Ethnicity	1.264 (42)												
Latino/Hispanic		.361	.469	.915	.459	.661	.819	-.448	.681	.760	.535	.705	.594
Black		1.084	.667	.000	.925	.960	1.181	-.408	1.141	-.152	.953	.807	.990
Native American		-.126	.447	.244	.452	.866	.622	-.981	.591	-1.194	.782	-.645	.796
Asian/Middle Eastern		-.181	.317	.238	.341	.350	.505	.324	.359	-1.716*	.660	-.852	.564
Multiracial		-.923*	.438	-.114	.389	.982	.522	.428	.365	.193	.420	-1.089	.780
Prefer not to respond		.215	.296	-.159	.375	.480	.511	-.367	.409	-.262	.427	.109	.447

*Note.* No SAE project served as the reference group for the independent variable. Female, freshman, not living on a farm, no response to English as the primary language, not receiving free/reduced lunch, unknown parental education, and white served as the reference groups, respectively. \*p < .05.

## References

- Agodini, R., Uhl, S., & Novak, T. (2004). Factors that influence participation in secondary vocational education. (Report No. 8879-400). Princeton, NJ: Mathematica Policy Research, Inc.
- Agresti, A., & Natarajan, R. (2001). Modeling clustered ordered categorical data: A survey. *International Statistical Review*, 69(3), 345-371. doi:10.1111/j.1751-5823.2001.tb00463.x
- Ahrens, C. A., Cox, C. K., Burris, S., & Dykes, M. (2015). Perceived leadership life skills developed through participation at the Arkansas FFA leadership conference: A program evaluation. *Journal of Leadership Education*, 14(1). doi: 1012806/V14/I1/R8
- Ary, D., Jacobs, L. C., & Sorensen, C. (2010). *Introduction to research in education* (8th ed.). Belmont, CA: Wadsworth Cengage Learning.
- Balschweid, M. A., & Talbert, B. A. (2000). *A comparison of agricultural education students to the "typical high school student" as quantified in the state of our nation's youth by the Horatio Alger Association: Final report*. Indianapolis, IN: National FFA Organization.
- Bayaga, A. (2010). Multinomial logistic regression: Usage and application in risk analysis. *Journal of Applied Quantitative Methods*, 5(2), 288-297.
- Brown, N. R., Terry, R., & Kelsey, K. D. (2013). The impact of learning styles on learning outcomes at FFA camp: What campers retain over time. *Journal of Agricultural Education*, 54(4), 206-220. doi: 10.5032/jae.2013.04206
- Bunch, J. C., Robinson, J. S., Edwards, M. C., & Antonenko, P. D. (2014). How a serious digital game affected students' animal science and mathematical competence in agricultural education. *Journal of Agricultural Education*, 55(3), 57-71. doi: 10.5032/jae.2014.03057
- Burris, S. & Garton, B.L. (2006). An investigation of the critical thinking ability of secondary agriculture students. *Journal of Southern Agricultural Education Research*. (56)1. 18 – 29. Retrieved from <http://www.jsaer.org/pdf/Vol56/56-01-018.pdf>
- Croom, D. B. & Flowers, J.L. (2001). Factors influencing an agricultural education student's perception of the FFA organization. *Journal of Agricultural Education*. 42(2). 28 – 37. doi: 10.5032/jae.2001.02028
- Croom, B. & Flowers, J.L. (2001). A question of relevance: FFA programs and services as perceived by FFA members and non-members. *Journal of Southern Agricultural Education Research*. (51)1. 6 – 19. Retrieved from <http://www.jsaer.org/pdf/Vol51/51-00-006.pdf>

- Croom, B., Moore, G. & Armbruster, J. (2009). An examination of student participation in National FFA Career Development Events. *Journal of Southern Agricultural Education Research*. (59)1, 109 – 121. Retrieved from <http://www.jsaer.org/vol59Whole.pdf>
- De Lay, A. M., & Swan, B. G. (2014). Student Apathy As Defined By Secondary Agricultural Education Students. *Journal of Agricultural Education*, 55(1), 106-119.
- de Leeuw, J., Meijer, E., & Goldstein, H. (2008). *Handbook of multilevel analysis*. New York, NY: Springer.
- Dillman, D. A., Smyth, J. D., & Christian, L. M. (2009). *Internet, mail, and mixed-mode surveys: The tailored design method* (3rd ed.). Hoboken, NJ: John Wiley & Sons.
- Esters, L. T. (2007). Factors influencing postsecondary education enrollment behaviors of urban agricultural education students. *Career and Technical Education Research*, 32(2), 79-98.
- Esters, L. T., & Bowen, B. E. (2005). Factors influencing career choices of urban agricultural education students. *Journal of Agricultural Education*, 46(2), 24-35.
- Finch, C. R., & Crunkilton, J. R., (1999). *Curriculum development in vocational and technical education: Planning, content, and implementation* (5<sup>th</sup> ed.). Boston: Allyn and Bacon.
- Friedel, C., Ricketts, J., Rhoades, E., Irani, T., Stedman, N. (2009). Student engagement in secondary agricultural education programs. (Research Report No. 32921). Baton Rouge: Louisiana State University, School of Human Resource Education and Workforce Development.
- Gbur, E. E., Stroup, W. W., McCarter, K. S., Durham, S., Young, L. J., Christman, M., ... & Kramer, M. (2012). Generalized linear mixed models. In *Analysis of Generalized Linear Mixed Models in the Agricultural and Natural Resources Sciences* (pp. 109-184). Madison, WI: American Society of Agronomy.
- Haynes, J. C., Robinson, J. S., Edwards, M. C., & Key, J. P. (2012). Assessing the Effect of Using a Science-Enhanced Curriculum to Improve Agriculture Students' Science Scores: A Causal Comparative Study. *Journal of Agricultural Education*, 53(2), 15-27.
- Hedeker, D. (2005). Generalized linear mixed models. *Encyclopedia of Statistics in Behavioral Science*. doi:10.1002/0470013192.bsa251
- Horstmeier, R. (2006). Leadership context and role of rural FFA members in the Southern Region. *Journal of Southern Agricultural Education Research*. (58)1. 150 – 162. Retrieved from <http://www.jsaer.org/pdf/Vol56/56-01-150.pdf>
- Horstmeier, R.P. & Nall, M. A. (2007). Youth leadership development: A national analysis of FFA member role and activity context. *Journal of Leadership Education*. 6(1). 143 – 157. Retrieved from [http://bigcat.fhsu.edu/jole/issues/Jole\\_6\\_1.pdf](http://bigcat.fhsu.edu/jole/issues/Jole_6_1.pdf)

- Hosmer, D. W., & Lemeshow, S. (2000). Interpretation of the fitted logistic regression model. *Applied Logistic Regression, Second Edition*, 47-90. doi: 10.1002/0471722146.ch3
- Israel, G., Myers, B., Lamm, A., & Galindo-Gonzalez, S. (2012). CTE Students and Science Achievement: Does Type of Coursework and Occupational Cluster Matter?. *Career and Technical Education Research*, 37(1), 3-20. doi: 10.5328/cter37.1.3
- Krumboltz, J. D., Mitchell, A. M., & Jones, G. B. (1976). A social learning theory of career selection. *The Counseling Psychologist*, 6(1), 71-81.
- Lawrence, S., Rayfield, J., Moore, L. L., & Outley, C. (2013). An analysis of FFA chapter demographics as compared to schools and communities. *Journal of Agricultural Education*, 54(1), 207-219. doi: 10.5032/jae.2013.01207
- Lundy, L. K., Ruth, A. M., & Park, T. D. (2007). Entertainment and agriculture: An examination of the impact of entertainment media on perceptions of agriculture. *Journal of Applied Communications*, 91(1&2), 65-79. doi: 10.4148/1051-0834.1257
- Martin, M. J., & Kitchel, T. (2014). Barriers to participation in the national FFA organization according to urban agriculture students. *Journal of Agricultural Education*, 55(1), 120-133. doi: 10.5032/jae.2014.01120
- National FFA Organization. (2015). *Agricultural education*. Retrieved from <https://www.ffa.org/about/agricultural-education>
- National Research Council. (2009). *Transforming agricultural education for a changing world*. Washington, D.C.: The National Academies Press.
- Park, T. D. & Osborne, E. (2007). Reading strategy instruction in secondary agriscience courses: An initial perspective. *Career and Technical Education Research* 32(1). 45 – 75.
- Peake, J.B., Briers, G., & Murphy, T. (2005). Relationships between student achievement and levels of technology integration by Texas agriscience teachers. *Journal of Southern Agricultural Education Research*. (58)1. 19 – 32. Retrieved from <http://www.jsaer.org/pdf/Vol55/55-01-019.pdf>
- Phelps, K., Henry, A. L., & Bird, W. A. (2012). Factors Influencing or Discouraging Secondary School Students' FFA Participation. *Journal of Agricultural Education*, 53(2), 70-86.
- Rayfield, J., Frazee, S., Brashears, T. & Lawver, D. (2007). The relationship between student demographic variables and performance in a National FFA Career Development Event. *Journal of Southern Agricultural Education Research*. 57(1). 4 – 15. Retrieved from <http://www.jsaer.org/pdf/Vol57/57-01-004.pdf>

- Reidel, J., Wilson, E., Flowers, J., & Moore G. (2007). Effects of an introductory agricultural education course on agricultural literacy and perceptions of agriculture in urban students. *Journal of Southern Agricultural Education Research*. 57(1). 82 – 94. Retrieved from <http://www.jsaer.org/pdf/Vol57/57-01-082.pdf>
- Ricketts, J. C., Priest, K., & Lastly, B. (2007). Student leadership practices of Georgia FFA Success conference participants. *Journal of Leadership Education*. (6)1. 158 – 173. Retrieved from [http://bigcat.fhsu.edu/jole/issues/Jole\\_6\\_1.pdf](http://bigcat.fhsu.edu/jole/issues/Jole_6_1.pdf)
- Rohs, F.R., Anderson, K., & Iverson, M.J. (2002). Achievement, affiliation and power needs of Georgia's middle grade agricultural education students. *Journal of Southern Agricultural Education Research*. 52(1). 24 – 39. Retrieved from <http://www.jsaer.org/pdf/Vol52/52-02-024.pdf>
- Rojewski, J. W., Lee, I. H., & Gemici, S. (2010). Using propensity score matching to determine the efficacy of secondary career academies in raising educational aspirations. *Career and Technical Education Research*, 35(1), 3-27.
- Scott, F.L. & Lavergne, D. (2004). Perceptions of high school students regarding the image of agriculture and barriers to enrolling in an agricultural education class. *Journal of Southern Agricultural Education Research*. 54(1). 48 – 59. Retrieved from <http://www.jsaer.org/pdf/Vol54/54-01-048.pdf>
- Swortzel, K.A., Jackson, G.B., Taylor, W.N. & Deeds, J.P. (2003). Attitudes of Mississippi secondary agricultural science and biology/business students towards information technology. *Journal of Southern Agricultural Education Research*. 53(1). 275 – 288. Retrieved from <http://www.jsaer.org/pdf/Vol53/53-03-275.pdf>
- Talbert, B.A. & Balschweid, M.A. (2004). Engaging students in the agricultural education model: Factors affecting student participation in the National FFA Organization. *Journal of Agricultural Education*. 45(1). 29 – 41. doi: 10.5032/jae.2004.01029
- Talbert, B.A. & Balschweid, M.A. (2006). Career aspirations of selected FFA members. *Journal of Agricultural Education*. 47(2). 67 – 80. doi: 10.5032/jae.2006.02067
- The White House. (2016). *Fact sheet: America the bountiful initiative to strengthen U.S. agricultural workforce* [Fact sheet]. Retrieved from <https://community.pepperdine.edu/gsep/dissertation/content/writing/apa-reference-and-citation-guide-6th-edition.pdf>
- Thoron, A.C. & Myers B.E. (2011). Impact of gender, ethnicity, year in school, social economic status, and state standardized assessment scores on student content knowledge achievement when using Vee Maps as a formative assessment tool. *Journal of Agricultural Education*. 52(1). 85-95. doi: 10.5032/jae.2011.01085

- Thoron, A. C., & Myers, B. E. (2011). Effects of Inquiry-Based Agriscience Instruction on Student Achievement. *Journal of Agricultural Education*, 52(4), 175-187.
- Thoron, A. C., & Myers, B. E. (2012). Effects of inquiry-based agriscience instruction on student scientific reasoning. *Journal of Agricultural Education*, 53(4), 156-170. doi: 10.5032/jae.2012.04156
- Ulrich, D., Pavelock, D., Muller, J. & Harrell, B. (2005). Student demographics, extracurricular participation and safety education of students participating in the 2003 Houston Livestock Show and rodeo agricultural mechanics project show. *Journal of Southern Agricultural Education Research*. 55(1). 129 – 140. Retrieved from <http://www.jsaer.org/pdf/Vol55/55-01-129.pdf>
- Witt, C., Doerfert, D. L., Ulmer, J. D., Burris, S., & Lan, W. (2013). An investigation of school connectedness among agricultural education students. *Journal of Agricultural Education*, 54(2), 186-204. doi: 10.5032/jae.2013.02186
- Wyatt, J. D., Shoulders, C. W., & Meyers, B. E. (2015). Socioscientific issues-based instruction: An investigation of agriscience students' argumentation skills based on student variables. *Journal of Southern Agricultural Education Research*. (65)1. Retrieved from <http://www.jsaer.org/pdf/Vol65/65-01-002.pdf>
- Yazzie-Mintz, E. (2010). *Charting the path from engagement to achievement: A report on the 2009 High School Survey of Student Engagement*. Bloomington, IN: Center for Evaluation & Education Policy.
- Young, R.B., Edwards, M.C., & Leising, J.G. (2008). Effects of a math-enhanced curriculum and instructional approach on students' achievement in mathematics: A year-long experimental study in agricultural power and technology. *Journal of Southern Agricultural Education Research*. (58)1. 4 – 17. Retrieved from <http://www.jsaer.org/pdf/vol58Whole.pdf>

# **Teacher Perception of the Georgia Middle School Agricultural Education Curriculum**

David L. Chapman, Auburn University

James R. Lindner, Auburn University

## **Abstract**

The purpose of this study was to describe teacher perceptions of the Georgia middle school agricultural education curriculum. This descriptive and correlational study utilized a quantitative non-experimental survey research design. The findings, conclusions, and resulting recommendations had four primary themes including agricultural educator professional development, the Georgia middle school agricultural education curriculum, curriculum development, and professional diversity. It was concluded that the middle school agricultural education curriculum has some specific areas for improvement to best meet the educational needs of the modern student. Every curriculum standard, across all grade levels, demonstrated a discrepancy between the level of importance placed on the curriculum standard and the student level of competency upon completion. These discrepancies were analyzed and reported in the form of mean weighted discrepancy scores (MWDS). These scores provided a list of curriculum standards ranked by MWDS and should be evaluated and addressed in order from highest to lowest. It was recommended that professional development opportunities, for both pre-service and in-service teachers, be provided to address curriculum concerns to ensure they meet each student's educational needs. It was also recommended that additional studies be conducted to determine if the middle school agricultural education curriculum is meeting the needs of the modern learner and its relationship to the recruitment and retention of students.

## **Introduction & Theoretical Framework**

Agricultural literacy is a growing issue across the United States as more and more individuals continue to become further removed from production agriculture. A more efficient agricultural industry combined with urban expansion has and will continue to greatly contribute to this phenomenon. The need for agricultural literacy is higher than it has ever been as fewer individuals are involved in production agriculture. Currently the number of individuals who are actively involved in production agriculture has fallen to under one percent (USEPA, 2012). Almost ninety percent of the United States population is two or three generations removed from direct involvement with the agriculture industry (Leising & Zilbert, 1994). The consistent decline in the number of individuals entering production agriculture in recent years has led to a society that does not possess the level of agricultural literacy required to make informed choices regarding consumer decisions and the ability to decipher between misleading and accurate literature about the agriculture industry.

Most individuals are completely unaware of the social and economic value of the agriculture industry and how their choices as consumers affect farming practices and food security (Richardson, 1999). This is partially caused by the fact that Americans have long reaped the benefits of a successful agricultural system that can meet the needs of the country. Americans spend less than ten percent of their disposable income on food, which has contributed to a successful society (USDA, 2014). However, easy access to food in the United States has further



increased the problems associated with agricultural literacy. The lack of knowledge about the agriculture industry has resulted in a greater number of policy makers and consumers not fully understanding how agriculture affects the economy and society than any other time in the history of the United States (Fritz & Moody, 1997). “Increasingly, society will be faced with issues at the social, economic and political interface of agriculture, which will require some basic literacy of the human designed agri-food system” (Hess & Trexler, 2011, p. 1). It is critical that individuals have a basic understanding of agriculture and realize the role that it plays in their life. Agricultural literacy is the process of being able to make informed decisions about the agriculture industry and the role that it plays within the economy and environment, while also being able to accurately defend your position when challenged with misleading information and counter arguments from other individuals who do not share the same understanding (Powell, Agnew, & Trexler, 2008).

The majority of citizens in the United States still have a simplistic view of agriculture and are only able to relate agriculture with farming and ranching (Blackburn, 1999). Most of these individuals do not even realize the important role that agriculture plays in their day-to-day life (Richardson, 1990). This lack of agricultural literacy must be overcome in order to protect the integrity of the agriculture industry as well as establish a population of well-informed consumers. As the world’s population steadily increases, it is critical to attract young people into the industry to meet growing demands. The future success of the agriculture industry lies in the hands of younger generations and they must be properly educated so that they understand the need for their role as an active participant in the food and fiber industry (Helsel & Huges, 1984). This focus on agricultural education will initiate a process of widespread agricultural literacy that will begin in the school systems across the country.

Agricultural education programs and students involved in agricultural activities through the FFA (National FFA Organization) continue to grow across the United States. This educational outlet is the perfect opportunity to educate young people about agriculture and prepare them to enter the economy as informed consumers. This educational experience in agriculture helps to address the issue of agricultural literacy that currently faces today’s agriculture industry. However, in order for this educational outlet to be effective, students must first be drawn to the idea of learning about agriculture and how it plays a critical role in their lives and the economy. The methods that are utilized to teach students about agriculture have a significant influence upon their attitude toward learning the material (Okiror, Matsiko, & Oonyu, 2011). It is critically important to gain a better understanding of how to attract students to this type of educational experience and how to effectively design the curriculum to facilitate enthusiasm and learning. This understanding will assist in the development of an agricultural education curriculum and FFA programs that will meet the needs of both the modern student and the overall goal of widespread agricultural literacy.

Middle school agricultural education programs are some of the earliest forms of formal education in agriculture that a student can receive in the United States. Agricultural education in middle school provides students with exposure to the agriculture industry and helps them to understand the requirements of careers within the field (Frick, 1993). The National FFA Organization formally introduced middle school agricultural education during the National Convention of 1988 (Rossetti, Padilla, & McCaslin, 1994). Middle school courses in agriculture

and natural resources provide students with the opportunity to learn about the agriculture industry at a young age, while also serving as a recruitment tool for secondary agricultural education courses and FFA programs. Middle school agricultural education offers a unique opportunity to provide students with a hands-on learning opportunity in agriculture that will contribute to the solution of agricultural literacy and promote continued involvement in the agriculture industry from a diverse population.

There is an evident lack of research on middle school agricultural education. This is a critical area for research in agricultural education specifically as it pertains to future program growth and development. Middle school agricultural education research is critical in the advancement of agricultural education and the research initiatives established by American Association for Agricultural Education (AAAE). This study assists in the solution to research priority number four which is meaningful, engaged learning in all environments (Roberts, Harder, & Brashears, 2016). More specifically, this study focuses on the solution to the research priority question, which states, “How can delivery of educational programs in agriculture continually evolve to meet the needs and interests of students?” (Roberts, Harder, & Brashears, 2016, p. 39).

Kolb’s (1984) experiential learning theory (Figure 1) served as the foundational epistemology of this study. “The term experiential learning is a broad term, generally used by educators to describe a series of pragmatic activities sequenced in such a way that it is thought to enhance the educational experience for the student learner” (Clark, Threton, & Ewing, 2010). Experiential learning has always been a cornerstone of agricultural education and a guiding theory for curriculum design (Roberts, 2006; Knobloch, 2003). “Agricultural education has always had a strong orientation toward learning by doing, or experiential learning” (Zilbert & Leske, 1989, p. 1). However, experiential learning is more than just learning by doing and educational experiences must be structured so as to strengthen the connection between cognitive learning and life skills (Wulff-Risner & Stewart, 1997). Kolb maintained the idea that learning “is not the special province of a single specialized realm of human functioning such as cognition or perception” (Kolb, 1984, p. 31).

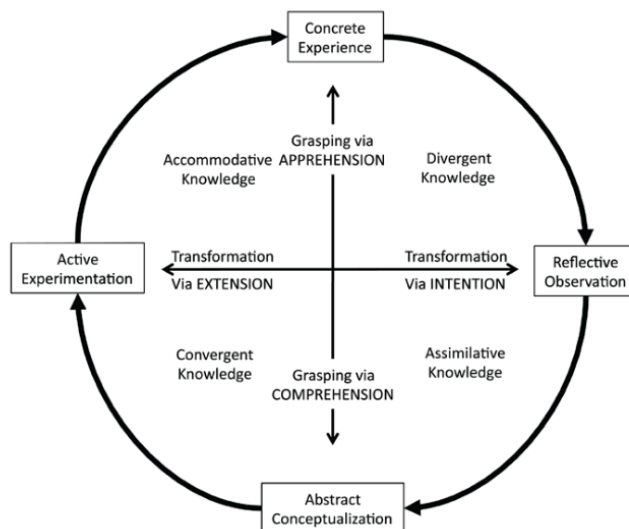

Figure 1. Model of Experiential Learning Process (Kolb, 1984).

Experiential learning theory views learning as an integrated approach, which includes learner characteristics and the relationship with the individual experience (Kolb, 1984). Experiential learning is closely related to constructivism, which posits that learning is a function of developing meaning from experiences (Doolittle & Camp, 1999). Agricultural educators provide students with hands-on learning opportunities in order to facilitate a better understanding of content and to develop concrete critical thinking and problem solving behaviors (Mabie & Baker, 1996). This is evident through the variety of experiential learning opportunities provided to students in the agricultural education curriculum including travel opportunities, supervised agricultural experience programs, problem solving methods, and service-based learning (Roberts, 2006). Experiential learning is a critical component of successful agricultural education programs because it engages students in the learning process and promotes critical thinking and problem based learning (Wozencroft, Pate, Griffiths, 2014).

Experiential learning is a critical component of agricultural education and is the foundational theory for all three components of the agricultural education model. Agricultural education provides a natural environment for experiential learning and provides students with the opportunity to move beyond the classroom and into relevant agricultural contexts. The cyclical learning process of ELT provides an excellent framework to the existing agricultural education program model (Figure 2). The three components of agricultural education align with the learning modes presented in the ELT model. Agricultural education naturally provides students with experiential learning opportunities in all learning modes through participation in the three components of agricultural education (Baker, Robinson, & Kolb, 2012).

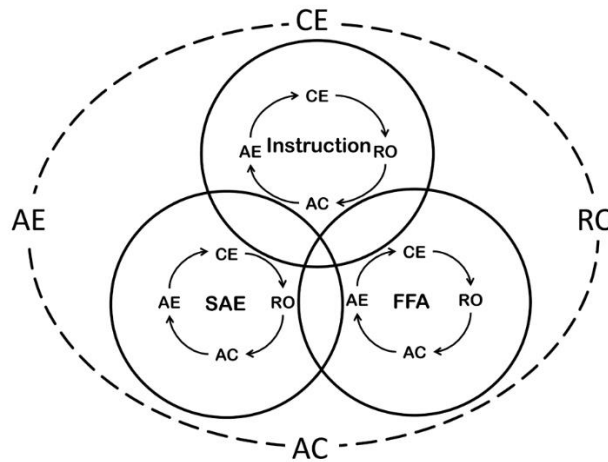

Figure 2. Comprehensive Model for Secondary Agricultural Education (Baker, Robinson, & Kolb, 2012).

Experiential learning in agricultural education requires consistent support from the instructor. Teachers are responsible for guiding and facilitating the experiential learning process. The agricultural educator must help students to connect the experience to a student's prior knowledge and personal interests. Many teachers fail to realize the importance of the connection between the teacher and the experience. Often times, too much focus is placed on structuring the experience and not enough on properly facilitating it. Agricultural educators play an important role in each phase of the learning process from concrete experience to active experimentation and ultimately to another concrete experience. Teachers must support students throughout this

learning process in order for it to be effective. This also means that teachers must purposefully design the curriculum in order to provide students with the experiences necessary to initiate the learning process (Baker, Robinson, & Kolb, 2012). Experiential learning plays a critical role in providing the educational opportunities necessary to increase student competence among curriculum standards, while subsequently increasing overall agricultural literacy. This student-centered experiential learning approach to curriculum/instructional design provides the greatest opportunity for student understanding, knowledge retention, and application. This assists in student competence upon specific curriculum standards in agricultural education and the spread of agricultural literacy as these students enter a global workforce and economy.

### **Purpose & Objectives**

The purpose of this study was to describe teacher perception of the middle school agricultural education curriculum. This study provided teachers with the opportunity to share their perception of the middle school agricultural education curriculum regarding the level of importance among each curriculum standard and the resulting level of competence among students at the conclusion of the course/program. Three research objectives were identified to guide the study:

1. Describe the perceived importance of the Georgia Department of Education State Standards for middle school agricultural education curriculum by teachers.
2. Describe the perceived level of student competence on the Georgia Department of Education State Standards for middle school agricultural education by teachers.
3. Determine the mean weighted discrepancy score by the teacher's perception of importance of the curriculum standard and the teacher's perception of student competence on the standard.

### **Methods**

This descriptive and correlational study used a quantitative non-experimental survey research design. Participants completed a two-part online questionnaire. The first part of the questionnaire was designed to collect data on teacher's perceived level of importance on the Georgia State Standards for middle school agricultural education and their perception of student competence on those standards upon completion. The second part of the questionnaire was designed to collect data on the personal characteristics of the participants.

The population for the study was all middle school agricultural education teachers in Georgia ( $N=97$ ). A simple random sample ( $n=71$ ) of the population was calculated using Cochran's (1977) sample size formula for continuous data and minimum return sample size. Middle school agricultural education teachers were contacted via the Qualtrics platform. Teachers received an email with information regarding the rationale for the study, which included a link to the questionnaire and a link to the information letter for the study. Follow-up emails were generated through the Qualtrics platform weekly until the needed sample was met. These emails went only to those individuals who had not started or completed all the items on the questionnaire. Follow-up emails were discontinued and the links remained active until responses ended naturally ( $n=72$ ).

Borich's needs assessment model was used in the development of the questionnaire. This model was beneficial because it provided direct and unambiguous recommendations that could be used for program growth and development. The questionnaire was designed so that participants could provide data, which could then be weighted and ranked in order of priority regarding curriculum discrepancies in middle school agricultural education. The discrepancies provided a ranked order of standards that need attention, modification, or development. The use of this model within the study had five main steps including, developing the list of student experiences in middle school agricultural education for the questionnaire, administering the questionnaire to participants within the sample, ranking discrepancies according to the rating obtained on the questionnaire, comparing the discrepancies that ranked highest with the standards to determine areas where students feel they are not receiving the appropriate level of involvement, and revising the curriculum or middle school agricultural education program model as necessary to meet student learning needs and desires (Borich, 1980). The Borich Needs Assessment model and the use of mean weighted discrepancy scores are also an effective method of identifying professional development needs of educators (Duncan, Ricketts, Peake, & Uessler, 2006; Layfield & Dobbins, 2002).

Agricultural education programs are designed to meet the needs of the local communities. Agricultural education teachers, along with the guidance of an advisory committee, design the curriculum to meet the local agricultural and community needs. Students receive different types of instruction in agricultural education depending on the type of agriculture found within the region that they live. Therefore, it was important to have the opportunity for individuals within each area of the state to be represented within the sample in order to get an accurate reflection of the entire population. The Georgia Agricultural Education leadership divides the state into three regions and further divides these regions into six areas that represent these differences. Each teacher that meets the study's criteria had an equal opportunity to be selected for inclusion within the study.

This study utilized a combination of analysis procedures via SPSS to appropriately analyze the data collected from each section of the questionnaire. Each objective of the study was analyzed and reported according to the type of data collected and the most appropriate method. Objective one was analyzed and reported using frequencies, percentages, means, and standard deviations as appropriate. Objective two was analyzed and reported using frequencies, percentages, means, and standard deviations as appropriate. Objective three was analyzed and reported by calculating mean weighted discrepancy scores.

There are two primary types of validity that were addressed within this study including content validity and face validity. Content validity was addressed by ensuring that items on the questionnaire were a reflection of the Georgia Standards for middle school agricultural education and the experiences that appropriately align with the curriculum. Faculty and graduate students at Auburn University served as a panel of experts to ensure content and face validity of the instrument. Measures of internal consistency were used to assess reliability. Cronbach's Alpha Coefficient was used as the measure of internal consistency within this study. Reliability for the three grades standards 6<sup>th</sup> grade, 7<sup>th</sup> grade, and 8<sup>th</sup> grade were also estimated by calculating and reporting Cronbach's Alpha. Cronbach's alpha was calculated to determine the reliability of

importance of curriculum standards ( $\alpha=0.72, 0.71, \& 0.94$ ) and student competence ( $\alpha=0.83, 0.78, \& 0.95$ ) scales for 6<sup>th</sup> grade, 7<sup>th</sup> grade, and 8<sup>th</sup> grade respectively.

## Findings

Seventy-two Georgia middle school agricultural education teachers responded to the questionnaire. This was one more than the calculated sample size according to Cochran's (1977) sample size formula for continuous data and minimum return sample size. Female teachers comprised the largest gender group of participants ( $f=41, \%=56.94$ ), while male respondents represented 43.06% ( $f=31$ ). All participants reported Caucasian/White for ethnicity ( $f=72, \%=100$ ). The teaching experience group with the highest number of participants were those with less than five years of teaching ( $f=31, \%=43.06$ ). The remaining participants represented the groups of teaching experience in the following breakdown 5-10 years ( $f=14, \%=19.44$ ), 11-15 years ( $f=15, \%=20.83$ ), 16-20 years ( $f=8, \%=11.11$ ), 21-25 years ( $f=3, \%=4.17$ ), and 26+ years ( $f=1, \%=1.39$ ). Participants represented all agricultural education regions of the Georgia with 41.67% ( $f=30$ ) reporting from the north region, 30.56% ( $f=22$ ) from the central region, and 27.78% ( $f=20$ ) from the south region.

The first objective sought to describe the perceived importance of the Georgia Department of Education State Standards for middle school agricultural education curriculum by teachers (Table 1). Teachers were asked to rate 32 curriculum standards using the Likert-type scales described in the methods section based upon Borich's Needs Assessment Model. The 32 standards were further separated according to the grade level (6-8) in which they are taught. As reported in Table 1, the top five curriculum standards with the highest means in regards to perceived importance were 6<sup>th</sup> Grade "Students will demonstrate the importance of agriculture in daily life" ( $M=4.74, SD=0.53$ ), 7<sup>th</sup> Grade "Express the importance of agriculture in daily life" ( $M=4.67, SD=0.61$ ), 8<sup>th</sup> Grade "Develop leadership skills, characteristics, and responsibilities" ( $M=4.67, SD=0.75$ ), 6<sup>th</sup> Grade "Students will state the importance of Georgia agriculture" ( $M=4.64, SD=0.56$ ), and 8<sup>th</sup> Grade "Develop an understanding of the FFA organization" ( $M=4.60, SD=0.71$ ).

The second objective sought to describe the perceived level of student competence on the Georgia Department of Education State Standards for middle school agricultural education by teachers (Table 1). Teachers were asked to rate 32 curriculum standards using the Likert-type scales described in the methods section based upon Borich's Needs Assessment Model. The 32 standards were further separated according to the grade level (6-8) in which they are taught. As reported in Table 1, the top five curriculum standards with the highest means in regards to perceived competency were 7<sup>th</sup> Grade "Express the importance of agriculture in daily life" ( $M=4.29, SD=0.68$ ), 8<sup>th</sup> Grade "Develop an understanding of the FFA organization" ( $M=4.25, SD=0.85$ ), 8<sup>th</sup> Grade "Identify the 3 main parts of the agricultural education program" ( $M=4.25, SD=0.68$ ), 6<sup>th</sup> Grade "Students will state the importance of Georgia agriculture" ( $M=4.15, SD=0.74$ ), and 6<sup>th</sup> Grade "Students will demonstrate the importance of agriculture in daily life" ( $M=4.15, SD=0.83$ ).

Table 1

*Importance and Competency Ratings of Middle School Ag Ed Curriculum Standards as Perceived by Georgia Middle School Agricultural Education Teachers.*

Curriculum Standard	Importance		Competency	
	<i>M</i>	<i>SD</i>	<i>M</i>	<i>SD</i>
6 <sup>th</sup> Grade Standards				
Students will demonstrate the importance of agriculture in daily life.	4.74	0.53	4.15	0.83
Students will express an understanding of the history of American Ag.	3.75	1.02	3.49	0.92
Students will state the importance of Georgia agriculture.	4.64	0.56	4.15	0.74
Establish an understanding of Ag Ed Programs.	4.39	0.81	3.94	0.96
Express knowledge of the area of horticulture.	4.24	0.85	3.88	0.85
Demonstrate an understanding of the area of animal science.	4.22	0.81	3.90	0.73
Describe examples of career clusters in agriculture.	3.99	1.00	3.54	1.01
7 <sup>th</sup> Grade Standards				
Express the importance of agriculture in daily life.	4.67	0.61	4.29	0.68
Compare/contrast the importance of Georgia agriculture.	4.39	0.70	4.11	0.74
Demonstrate an understanding of the FFA Organization.	4.44	0.73	4.08	0.83
Express an understanding of the area of agriscience.	3.93	0.97	3.69	0.96
Build an understanding of the area of forestry & natural resources.	4.29	0.76	4.04	0.83
Critique the area of agricultural mechanics.	4.11	0.99	3.74	1.02
8 <sup>th</sup> Grade Standards				
Identify the 3 main parts of the ag ed program.	4.40	0.90	4.25	0.85
Develop an understanding of the FFA organization.	4.60	0.71	4.25	0.80
Develop leadership skills, characteristics, and responsibilities.	4.67	0.75	4.04	0.90
Develop and use verbal and nonverbal communication skills.	4.43	0.85	3.96	0.88
Develop work ethic & employable skills through ag ed & leadership.	4.49	0.86	3.90	0.94
Students will define and explain the horticulture industry.	4.31	0.70	4.04	0.81
Students will identify plant parts and their functions.	4.39	0.72	4.13	0.75
Students will define methods of plant propagation (sexual or asexual).	4.29	0.76	3.85	0.91
Students will identify plant growth requirements.	4.40	0.74	4.10	0.81
Students will define the forestry & natural resource industry.	4.29	0.76	3.99	0.78
Students will identify the importance of the forest.	4.22	0.86	3.88	0.79
Students will be able to classify/list examples of trees by region.	4.07	0.98	3.64	0.94
Students will explain conservation/preservation of natural resources.	4.31	0.72	3.83	0.87
Student will be able to describe wildlife and their habitat.	4.28	0.83	3.94	0.95
The students will identify the role of agriscience in human needs.	4.14	0.86	3.65	0.97
The student will identify current trends/issues relating to agriscience.	3.99	0.97	3.54	0.90
The student will apply agriscience in animal research and production.	3.99	0.96	3.51	1.06
The student will apply agriscience in plant research and production.	3.97	0.92	3.43	0.99
The student will identify career clusters in the field of agriscience.	4.15	0.83	3.64	1.01

<sup>1</sup>Scale of 1= *Low Importance*; 5= *High Importance*

<sup>2</sup>Scale of 1= *Low Student Competence*; 5= *High Student Competence*

The third objective sought to determine the mean weighted discrepancy score by the teacher's perception of importance of the curriculum standard and the teacher's perception of student competence on the standard (Table 2). The discrepancy between teacher perceived importance of each curriculum standard (by grade level) and student competency upon completion of that standard is represented by the mean weighted discrepancy score (MWDS).

Table 2

*Mean Weighted Discrepancy Scores by Grade Level and Curriculum Standard.*

Curriculum Standards	MWDS <sup>1</sup>
6 <sup>th</sup> Grade Standards	
Students will demonstrate the importance of agriculture in daily life.	2.76
Students will state the importance of Georgia agriculture.	2.26
Establish an understanding of Agricultural Education Programs.	1.95
Describe examples of career clusters in agriculture.	1.77
Express knowledge of the area of horticulture.	1.53
Demonstrate an understanding of the area of animal science.	1.35
Students will express an understanding of the history of American agriculture.	0.99
7 <sup>th</sup> Grade Standards	
Express the importance of agriculture in daily life.	1.75
Demonstrate an understanding of the National FFA Organization.	1.60
Critique the area of agricultural mechanics.	1.54
Compare/contrast the importance of Georgia agriculture.	1.22
Build an understanding of the area of forestry & natural resources.	1.07
Express an understanding of the area of agriscience.	0.93
8 <sup>th</sup> Grade Standards	
Develop leadership skills, characteristics, and responsibilities.	2.92
Develop work ethic and employable skills through ag ed/leadership programs.	2.62
The student will apply agriscience in agricultural plant research and production.	2.15
The student will identify various career clusters in the field of agriscience.	2.13
Develop and use verbal and nonverbal communication skills.	2.09
Students will explain the conservation/preservation of natural resources.	2.03
The students will identify the role of agriscience in meeting human needs.	2.01
Students will define methods of plant propagation (sexual or asexual).	1.91
The student will apply agriscience in animal research and production.	1.88
The student will identify current trends and issues relating to agriscience.	1.77
Students will be able to classify and list examples of trees specific to our region.	1.75
Develop an understanding of the FFA organization.	1.60
Students will identify the importance of the forest.	1.47
Student will be able to describe wildlife and their habitat.	1.43
Students will identify plant growth requirements.	1.35
Students will define the forestry & natural resource industry.	1.31
Students will identify plant parts and their functions.	1.16
Students will define and explain the horticulture industry.	1.14
Identify the 3 main parts of the agricultural education program.	0.67

<sup>1</sup>Mean Weighted Discrepancy Score



The middle school agricultural education curriculum standards are ranked by priority in Table 3. This table reports the top ten curriculum standards with the highest mean weighted discrepancy scores. Among the top ten curriculum standards with the highest MWDS, eighth grade was represented seven times, sixth grade was represented three times, and seventh grade was not represented in the top ten.

Table 3

*Top Ten Mean Weighted Discrepancy Scores From All Curriculum Standards (Grade 6-8).*

Grade	Curriculum Standards	Rank	MWDS <sup>1</sup>
8th	Develop leadership skills, characteristics, and responsibilities.	1	2.92
6th	Students will demonstrate the importance of agriculture in daily life.	2	2.76
8th	Develop work ethic and employable skills through agricultural education and leadership programs.	3	2.62
6th	Students will state the importance of Georgia agriculture.	4	2.26
8th	The student will demonstrate the application of agriscience in agricultural plant research and production.	5	2.15
8th	The student will identify various career clusters in the field of agriscience.	6	2.13
8th	Develop and use verbal and nonverbal communication skills.	7	2.09
8th	Students will explain the importance of conservation and preservation of natural resources.	8	2.03
8th	The students will identify the role of agriscience in meeting human needs.	9	2.01
6th	Establish an understanding of Agricultural Education Programs.	10	1.95

<sup>1</sup>Mean Weighted Discrepancy Score

### **Conclusions, Implications, & Recommendations**

Agricultural educators should understand their unique role in the teaching and learning process and ensure that each standard and the middle school agricultural education curriculum as a whole is presented according to the educational needs of the students. The instructional design of the course should be designed to meet the needs of the local community and the educational needs and desires of the students being served. The instructional methods/strategies used will have a resulting impact upon overall student experience in agricultural education and competency upon completion. Agricultural educators should keep this in mind during the instructional design process.

The educational needs and desires of students are constantly changing and it is important for the agricultural education curriculum and instructional strategies to be consistently reviewed and altered as needed to meet these needs. Agricultural educators should adjust teaching methods and strategies to meet the educational needs of the modern learner. Teachers must understand that curriculum and methods should be based upon a fluid system that can be changed or altered to meet the needs of a diverse student population. This is essential to ensure that students have the best educational experience possible. Meeting these diverse educational needs are also

important in regards to student competency of curriculum standards upon completion. If the curriculum is not designed and presented according to the educational needs of the modern learner, then retention of information will be affected. This process also affects a student's perception of agricultural education, as the greatest portion of their time will be spent in the classroom. This perception will not only impact competency, but will also influence a student's secondary enrollment decision. Agricultural educators should learn the educational needs and desires of their students and ensure that the curriculum and instructional strategies are designed to appropriately address those needs.

Professional development opportunities will provide teachers a means of learning how to close the gap between importance and competency among identified standards. Agricultural educators should seek out assistance and professional development opportunities in agricultural education program areas or curriculum standards when a specific weakness or area of potential growth is identified. While it is important to develop these opportunities for teachers, it is also necessary for teachers to perform a self-evaluation and attend the professional development opportunities in areas of need. Additionally, state staff and teacher educators in agricultural education should continually evaluate these professional development opportunities. This will help to determine overall program effectiveness as it pertains to the specific needs of the teachers and assist in identifying the necessary changes to the design/implementation of the professional development opportunity. However, the result of this professional growth will have a direct impact on student competency and teacher confidence in the curriculum and instructional design process.

Agricultural education state staff and teacher educators should review the middle school agricultural education curriculum standards with the highest MWDS to determine possible solutions to close the gap between standard importance and student competence. The standards with the highest MWDS represent the greatest discrepancy between what teachers feel is important and how competent students are upon completion. The standards with the highest discrepancy scores should be carefully reviewed to determine the cause. Appropriate action should be taken to reduce this discrepancy and ensure that teachers understand the value of each standard and how to utilize the most appropriate teaching methods/strategies to increase student competency.

The impact of years of teaching experience on MWDS should be further investigated. As teachers began to exceed ten years of teaching experience, MWDS began to drop. The effect of years of teaching experience on the discrepancy between standard importance and student level of competence is evident, but warrants further investigation. Teachers, separated by years of experience, with higher and lower MWDS should be studied to determine the cause of these discrepancies. Specifically, further research should examine the relationship between MWDS and years of teaching experience based upon individual curriculum standards. A specific study should further examine the relationship between MWDS and teachers with 11-15 years of teaching experience based upon individual curriculum standards, as this group had the overall lowest MWDS. The results of these studies could provide insight into the reasons and potential solutions necessary to lower discrepancies among all groups of agricultural educators.

Further research regarding the middle school agricultural education curriculum standards is warranted. There is a need to further investigate each curriculum standard to determine if the standards are an accurate reflection of what is needed for the education of the modern learner. There may be curriculum standards that need to be added to the middle school agricultural education curriculum or removed to better address these needs. The results of these studies will provide information needed for the creation of a curriculum appropriately designed to meet the needs of the modern learner. Research should also be conducted to determine if middle school agricultural education teachers can accurately ascertain curriculum standard importance and student competence upon completion. The ability of a teacher to have a sound understanding of this process is critical in the design of effective instructional methods and could have an impact on the data collected in this study. This would also assist in understanding if teachers can effectively break down curriculum standards to teach based upon the needs of desires of each learner.

The educational needs and desires are constantly changing with each new generation of students. It is critical to understand these students and their unique needs in order to provide them with an appropriate educational experience. Agricultural education must continually change and adapt to meet the changes of society and learner needs in order to remain relevant and provide rigor to a student's educational experience. The ability to effectively recruit and retain students in agricultural education programs is dependent upon the design of an educational experience that will meet their educational needs and desires. This will provide students with an educational program that they will enjoy and find appealing, while also challenging them academically and providing rigor to their education. Research should be conducted to determine the best instructional strategies and methods to meet the educational needs of the modern learner in regards to the middle school agricultural education standards/curriculum. Agricultural education must remain flexible in design in order to address the changing needs of each new generation of learners.

This study was focused upon the Georgia middle school agricultural education curriculum, however it would be beneficial to conduct the study in other states to identify national trends in middle school agricultural education curriculum and its relationship to secondary enrollment. It is recommended that studies utilizing similar methods be conducted in other states to determine curriculum needs and the design of effective professional development opportunities to address those needs. These studies can be used to strengthen middle school agricultural education programs across the country and assist in the areas of recruitment and retention of students in agricultural education. Through specific research initiatives, each state can design a curriculum best suited to the unique educational needs and desires of their students, which will ultimately assist in providing each student with the best possible experience in agricultural education. This will lead to the growth and development of programs in agricultural education that will prepare students for post-secondary success, a lifetime of informed consumer decisions, and entry into a global and diverse workforce.

## References

- Baker, M. A., Robinson, J. S., & Kolb, D. A. (2012). Aligning Kolb's experiential learning theory with a comprehensive agricultural education model. *Journal of Agricultural Education, 53*(4), 1-16. doi: 10.5032/jae.2012.0400
- Blackburn, D. A. (1999). Ag science fairs: The next wave in agricultural literacy. *Journal of Extension, 37*(4), 1-3.
- Borich, G. D. (1980). A needs assessment model for conducting follow-up studies. *The Journal of Teacher Education, 31*(3), 39-42.
- Clark, R. W., Threton, M. D., & Ewing, J. C. (2010). The potential of experiential learning models and practices in career and technical education & career and technical teacher education. *Journal of Career and Technical Education, 25*(2), 46-62.
- Cochran, W. G. (1977). *Sampling techniques* (3rd ed.). New York: John Wiley & Sons.
- Doolittle, P. E., & Camp, W. G. (1999). Constructivism: The career and technical education perspective. *Journal of Vocational and Technical Education, 16*(1), 1-17.
- Duncan, D. W., Ricketts, J. C., Peake, J. B., & Uessler, J. (2006). Teacher preparation and in-service needs of Georgia agriculture teachers. *Journal of Agricultural Education, 47*(2), 24-35. doi: 10.5032/jae.2006.02024
- Frick, M. (1993). Developing a national framework for middle school agriculture education curriculum. *Journal of Agricultural Education, 34*(2), 77-84. doi: 10.5032/jae.1993.02077
- Fritz, S. & Moody, L. (1997). Assessment of junior high/middle school agriculture education programs in Nebraska. *Journal of Agriculture Education, 38*(1), 61-65. doi: 10.5032/jae.1997.01061
- Helsel, D. G., & Hughes, L. B. (1984). Urban students in agriculture: The challenge. *Journal of Agronomic Education, Vol. 13*, 31-33.
- Hess, A. J. & Trexler, C. J. (2011). A qualitative study of agricultural literacy in urban youth: What do elementary students understand about the agri-food system? *Journal of Agricultural Education, 52*(4), 1-12. doi: 10.5032/jae.2011.02151
- Knobloch, N. A. (2003). Is experiential learning authentic? *Journal of Agricultural Education, 44*(4), 22-34. doi: 10.5032/jae.2003.04022
- Kolb, D. A. (1984). *Experiential learning*. Englewood Cliffs, NJ: PrenticeHall.

- Layfield, K. D., & Dobbins, T. R. (2002). In-service needs and perceived competencies of South Carolina agricultural educators. *Journal of Agricultural Education*, 43(4), 45-65. doi: 10.5032/jae.2002.04046
- Leising, J. G. & Zilbert, E. E. (1994). Validation of the California agricultural literacy framework. *Proceedings of the National Agricultural Education Research Meeting, USA*, 21, 112-119.
- Mabie, R., & Baker, M. (1996). A comparison of experiential learning strategies upon the science process skills of urban elementary students. *Journal of Agricultural Education*, 37(2), 1-7. doi: 10.5032/jae.1996.02001
- Okiror, J. J., Matsiko, B. F., & Oonyu, J. (2011). Just how much can school pupils learn from school gardening? A study of two supervised agricultural experience approaches in Uganda. *Journal of Agricultural Education*, 52(2), 24-35. doi: 10.5032/jae.2011.02024
- Powell, D., Agnew, D., & Trexler, C. (2008). Agricultural literacy: clarifying vision for practical application. *Journal of Agricultural Education*, 49(1), 85-98. doi: 10.5032/jae.2008.01085
- Ravid, R. (2011). *Practical Statistics for Educators*. 4<sup>th</sup> Ed. University Press of Americas, Inc.: Lanham, MD.
- Richardson, L. (1990). Reinforcing the common bond between urban and agricultural interests. *The Agricultural Education Magazine*, 62(9), 7-18.
- Richardson, R. H. (1999). Ag education as urban survival school. *The Agricultural Education Magazine*, 71(4), 18-19.
- Roberts, T. G. (2006). A philosophical examination of experiential learning theory for agricultural educators. *Journal of Agricultural Education*, 47(1), 17–29. doi: 10.5032/jae.2006.01017
- Roberts, T. G., Harder, A., & Brashears, M. T. (2016). *American Association for Agricultural Education national research agenda: 2016-2020*. Gainesville, FL: Department of Agricultural Education and Communication.
- Rossetti, R., Padilla, D., & McCaslin, N.L. (1994). *An examination of middle school enrollment in agricultural education and membership in the National FFA Organization in the United States*. Columbus: Ohio State University, Department of Agricultural Education, Research 73.
- United States Department of Agriculture, Economic Research Service (2014). *Food prices and spending*. Retrieved from: <http://www.ers.usda.gov/data-products/ag-and-food-statistics-charting-the-essentials/food-prices-and-spending.aspx>

U.S. E.P.A. (2012). *Crop production*. Retrieved from U.S. Environmental Protection Agency.  
<http://www.epa.gov/agriculture/ag101/printcrop.html>

Wozencrofte, A. J., Pate, J. R., & Griffiths, H. K. (2014). Experiential learning an its impact on students' attitude toward youth with disabilities. *Journal of Experiential Education*, 38(2), 129-143. doi: 10.1177/1053825914524363

Wulff-Risner, L., & Stewart, B. (1997). Using experiential learning to teach evaluation skills. *Journal of Agricultural Education*, 38(3), 43-50. doi: 10.5032/jae.1997.03043

Zilbert, E., & Leske, G. (1989). Agricultural education and experiential learning. *The Visistor*, 76(1), 1-4.

# **Impact of Teacher Attire on Students' Views of Teacher Credibility, Attitude Homophily, and Background Homophily within School-based Agricultural Education Programs**

Lesley Smith, University of Arkansas  
Dr. Catherine Shoulders, University of Arkansas

## **Abstract**

School-based agricultural education teachers can face conflicting role obligations and role conflict when contradictory expectations accompany their positions, making the daily selection of what to wear difficult for these educators. The decision is crucial, however; dress sends strong messages of the profession to others, including students. We used a multiple case study design to examine the impact of teacher attire on students' perceptions of attitude homophily, background homophily, and teacher credibility. Findings indicated differing perceptions of business professionally, business casually, and casually dressed agriculture teachers between cases. Further, data suggested students' expectations for teacher attire varied by content matter, with agricultural mechanics content requiring more casual clothing. We recommend teachers wear business casual clothing most frequently in order to moderate between students' teacher-related and agriculturalist-related expectations, while shaping students' views regarding the professionalism of the agricultural, food, and natural resources industry.

## **Introduction/Conceptual Framework**

The global agricultural, food, and natural resources (AFNR) industries are facing the challenge of supplying a growing population with safe, affordable food from limited resources (STEM Food and Ag. Council, 2014). As technology and social systems evolve, the business of agricultural production is requiring more expertise in an increasingly diverse array of disciplines. A robust human capital pipeline has been identified as the vehicle capable of building an AFNR workforce prepared to conquer this challenge. However, the industry has struggled to fill that pipeline with scientists prepared to work in agricultural positions. Universities have been producing one-twelfth of the graduates needed to fill the nation's AFNR positions, suggesting a need to increase the number of students interested in entering that human capital pipeline.

One of the barriers to recruiting students to AFNR degree programs is the lack of awareness students have regarding the scope of careers within AFNR industries (Coalition for a Sustainable Agricultural Workforce, n.d.; National Academy of Sciences, 2009). "The diverse and broader student body is generally unaware of the multi-dimensional and challenging nature of the agricultural disciplines and the exciting career opportunities open to them" (National Academy of Sciences, 2009, p. 4). The STEM Food and Ag. Council (2014) recognized "the growing need for young, talented people in a variety of fields and disciplines to consider embarking on a career in the food and agriculture industry" (p. 14) as a key issue compounding the global hunger problem, and recommended that institutions "raise awareness among young people about the abundance of professional opportunities in food and agriculture" (p. 52). The Coalition for a Sustainable Agricultural Workforce (n.d.) stated that "misconceptions steer students in the basic sciences away from careers in the agricultural sciences" (overview, para. 5).

School-based agricultural education programs can assist in filling the human capital pipeline, as agricultural education courses maintain a dedicated focus on career exploration and college and career readiness across the AFNR disciplines (DeLuca, Plank, & Estacion, 2006; Roberts, Harder, & Brashears, 2016). Smith (2010) found enrollment in school-based agricultural education classes to be associated with positive perceptions about agriculture. Dyer, Breja, and Wittler (2002) reported previous enrollment in a school-based agricultural education program to be one of the most important factors in students' completion of a postsecondary degree in a college of agriculture.

As the leader of the school-based agricultural education program, the agriculture teacher is an influential mentor in guiding students toward the various science-based careers within the AFNR industries (Terry & Briers, 2010). As representatives of the larger AFNR industry, agriculture teachers offer many students their first impressions of the skills needed for, knowledge required by, and culture found within AFNR careers. Included in the formation of these first impressions are the teachers' physical attributes and behaviors (Carney, Colvin, & Hall, 2007; Simons, 1995). Attributes can include aspects out of the teacher's control, such as age and gender, and those within the teacher's control, such as attire (Barrick, Shaffer, & DeGrassi, 2009). These first impressions can shape students' perspectives regarding the similarity between their own concepts of self and perceptions of occupations within AFNR, a powerful factor in occupational choice (Gottfredson, 1981).

There are different standards for dress that are often dependent on work environment and culture; sartorial choices display one's roles, authority, and status within a profession (Morris, Gorham, Cohen, & Huffman, 1996). While district policies differ, employee handbooks have been found to maintain expectations of professional dress for teachers (Workman & Freeburg, 2010). Simmons (1996) posited that teachers can garner respect for themselves and their profession through their clothing, stating, "without question, dress sends a strong message about who teachers are as individuals and as professionals" (p. 298). Workman and Freeburg (2010) echoed the importance of attire within the teaching profession, stating the high influence teachers' clothing had on the general public's perceptions of the teaching profession. Previous research has displayed the impact of attire on students' perceptions of teachers. The literature is replete with findings indicating teachers dressed in casual attire are preferred by students, who view them as approachable and flexible, but not well-respected (Butler & Roesel, 1989; Carr, Lavin, & Davies, 2009; Lukavsky, Butler, & Harden, 1995). Additionally, these casually dressed teachers are more likely to experience student misbehavior (Roach, 1997). Similarly, teachers dressed more professionally have been found to be less preferable and perceived as less connected to students, but overwhelmingly more competent (Butler & Roesel, 1989; Morris et al., 1996; Shoulders et al., 2017). Morris et al. (1996) stated, "the same formal clothing that serves to increase perceptions of credibility, intelligence, and competence, and to increase compliance, has been reported to have the effect of decreasing perceptions of likability or approachability" (p. 137).

Teachers can face conflicting role obligations and role conflict when contradictory expectations accompany their positions (Workman & Freeburg, 2010). Agriculture teachers not only represent the teaching profession, but also represent the AFNR industry. Careers within AFNR have historically been carried out in outdoor settings requiring manual labor, but currently encompass a vast array of scientific careers carried out within professional settings (National Research



Council, 2009). Gordon (2010) stated that within educational subject areas in which sartorial expectations may conflict, the teacher must dress in a manner that displays the teacher's ability and willingness to engage in practices within the occupation. Shoulders et al. (2017) found that students' perceptions of agriculture teachers dressed in varying degrees of professional attire were dependent upon the students' previous experience within agriculture classes; students who had been enrolled in at least one high school agriculture course perceived agriculture teachers dressed less professionally as more competent to teach agricultural content. Further, they perceived those dressed more professionally to be less competent to teach agricultural content. These findings led Shoulders et al. (2017) to recommend that agriculture teachers actively select attire according to the messages they want to send to their students about the agriculture profession. They also recommended that further research be conducted "to determine how teacher attire impacts students' perceptions and expectations of the agriculture teachers" (p. 125). This study addresses their recommendation by examining the impact of teacher attire within the context of school based agricultural education programs on students' perceptions of agriculture teachers' credibility and perceptions of the similarity between their senses of self and their beliefs about the teacher as a representative of the AFNR industry.

### **Theoretical Framework**

This study was guided by Gottfredson's (1981) theory of occupational aspirations and expectancy violations theory (EVT) (Burgoon & Hale, 1988). According to the theory of occupational aspirations, an individual's self-concept, including items such as appearance, gender, social class background, intelligence, and vocational interests, competencies and values, is shaped over time and guides the individual toward and away from occupations that align with or are misaligned with this self-concept. As a child ages into adolescence, "each of the developing self-concepts is used as an additional criterion by which to make more critical assessments of job-self compatibility" (Gottfredson, 1981, p. 549). The elimination of jobs that are viewed as misaligned with one's self-concept occur in stages:

Occupations that are perceived to be inappropriate for one's sex are first eliminated from further consideration. Next, youngsters begin to rule out occupations of unacceptably low prestige because they are inconsistent with their social class self-concept. At the same time they rule out occupations requiring extreme effort to obtain in view of their image of their general ability level. Only in adolescence to youngsters turn to their more personal interests, capacities, and values as criteria for further narrowing their choices. Thus, the exploration of vocational alternatives in adolescence is largely within the set of occupations that were deemed compatible at earlier ages according to one's more visible social attributes...and one's sense of what is available with reasonable effort (Gottfredson, 1981, p. 549).

As occupations are further pursued, barriers related to accessibility cause individuals to choose between "sacrificing compatibility according to vocational interests, job level, or femininity/masculinity of the job" (Gottfredson, 1981, p. 549). Aspects further from the core of one's self-concept, such as vocational interests, are more readily given up than those that are more central to one self-concept, such as gender appropriateness of a job.

The process by which individuals pursue and eliminate potential occupations relies on occupational images (also termed occupational stereotype within the literature) (Gottfredson, 1981). Generalizations made about an occupation, including “the personalities of people in those jobs, the type of work they do, the type of lives they lead, the rewards and conditions of the work, and the appropriateness of the job for different types of people” form the image by which individuals determine compatibility between the occupation and their concept of self (Gottfredson, 1981, p. 547). Studies examining occupational images have found that occupations are perceived similarly by the general population,

no matter what their sex, social class, educational level, ethnic group, area of residence, occupational preferences or employment, age, type of school attended, political persuasion, and traditional of beliefs, and regardless of the decade of the study or the specific way in which questions were asked (Gottfredson, 1981, p. 550).

However, ratings of occupations is dependent on homophily; individuals rate jobs perceived to be held by people similar to themselves as more favorable than those held by people less like them (Himmelweit, Halsey, & Oppenheim, 1952; Reiss, 1961).

As representatives of the AFNR industry, agriculture teachers offer students an opportunity to further define their occupational images of AFNR careers, as well as evaluate the homophily between themselves and AFNR occupations. According to EVT, the interaction between agriculture teachers and their students shape students’ expectations of what agriculture teachers should know and do, which can influence their perceptions of other agriculture teachers (Burgoon & Hale, 1988), and whether their concepts of self are compatible with the occupation of agricultural education (Gottfredson, 1981). Interaction with other agriculture teachers who behave in a way that is different from the students’ expectations can be viewed as positively or negatively:

Clothing behavior is an area for obvious application of EVT given that we hold expectations for what appropriate attire is and what certain types of dress mean when they violate these social norms. There is little doubt that style of dress influences the attributions made about the wearer” (Dunbar & Segrin, 2012, p. 2)

The theory of occupational aspirations was utilized to guide this study’s independent and dependent variables. The AFNR industry has been experiencing a shift in occupational image as its reliance on science-based and professional disciplines increases; a corresponding shift in how AFNR careers are viewed by those making occupational choices can reduce misconceptions about the industry and combat the shortage of qualified people interested in filling these positions. The value of attire on the general public’s views about a profession (Dunbar & Segrin, 2012), the role of attire in shaping perceptions of homophily and expectations of teacher competence (Morris et al., 1996), the influence of homophily on occupational image (Gottfredson, 1981), and the conflicting sartorial expectations of traditional agriculturalists, teachers, and scientific professionals (Dunbar & Segrin, 2012; Shoulders et al., 2017) warranted the examination of teachers’ sartorial choices as an independent variable possible of influencing the dependent variables of student-teacher homophily and student perceptions of teacher credibility.

Expectancy violations theory was utilized to guide the design of the study. Because students' previous interactions with teachers in their home school based agricultural education programs shapes their expectations regarding the sartorial choices of agriculture teachers, we utilized a multiple case study design. Case studies are useful in instances when the phenomenon to be investigated is not sharply distinguishable from the context in which it is observed (Yin, 2014). Therefore, case studies are appropriate "when you want to understand a real-world case and assume that such an understanding is likely to involve important contextual conditions pertinent to your case" (Yin, 2014, p. 16). Because expectations of teacher attire are formed in part from previous interactions with agriculture teachers, and sartorial violations of those expectations can be viewed positively or negatively, we analyzed the impact of teacher attire on students' perceptions of homophily with the teacher and teacher credibility by school, seeking to generalize to the theoretical propositions within the theories of occupational aspirations and expectancy violations rather than to populations (Yin, 2014).

## **Methods**

This study utilized a series of quasi-experiments within a multiple case study design. Four school based agricultural education programs, purposively selected to include only programs wherein multiple sections of the same agriculture class were taught, were recruited to participate. A thorough description of each case's context and treatment implementation follows the explanation of the purpose, objectives, treatments, instrumentation, data collection, and data analysis, which were uniform across all cases.

### **Purpose and Objectives**

The purpose of this study was to determine the impact of teacher attire on students' perceptions of teachers' credibility and homophily between themselves and the teacher.

To meet this purpose, the following objectives were carried out for each of four cases:

1. Describe students' attitude homophily, background homophily, and perceptions of teacher credibility after experiencing a lesson delivered by a teacher dressed in business professional attire, business casual attire, or casual attire.
2. Determine differences between students' perceptions by treatment group.

### **Treatments**

Two graduate assistants who were certified to teach high school agriculture but who did not have any previous interaction with students in the four sites served as guest instructors. The guest instructors were similar in age and in teaching experience, but were different genders. Once sites were selected, the guest instructors were randomly assigned to teach prepared lessons within each site. The same guest instructor taught the same lesson in multiple sections of the same class within a site, so attire was the only manipulated variable. In sites with two sections of the same class, guest instructors wore casual attire while teaching one section and business professional attire while teaching the other section. In sites with three sections of the same class, the guest instructor wore business casual attire to the third class. Form of attire was randomly assigned to

each class within a site. Operational definitions for each form of attire was established through a review of literature (Morris et al., 1996) and was validated by an expert in apparel studies. See Table 1 for operational definitions of each form of attire.

Table 1

*Operational Definitions of each Form of Attire for Male and Female Guest Instructors*

Form of Attire	Operation for Male Guest Instructor	Operation for Female Guest Instructor
Business professional	Dress shirt with tie, dress slacks, jacket, brown or black shoes	Blouse and knee-length skirt and blazer, low-heeled brown or black shoes
Business casual	Dress shirt and khakis, brown shoes or boots	Dress shirt or blouse and khakis, flat shoes or boots
Casual	Polo or plain t-shirt, jeans, boots or flat casual shoes	Polo or plain t-shirt, jeans, boots flat casual shoes

Two 50-minute lesson plans were developed to meet the objectives within SBAE courses. One lesson was titled “How does ice cream get to our table?” and was aligned with The National Council for Agricultural Education’s (2015) Career Pathway Content Standards AS.01 (Analyze historic and current trends impacting the animal systems industry), FPP. 03 (Select and process food products for storage, distribution and consumption), and FPP.04 (Explain the scope of the food industry and the historical and current developments of food products and processing). This lesson was designed to be taught in introductory agriculture courses and food science courses. For SBAE programs with multiple agricultural mechanics courses, a lesson plan titled “Repairing an Extension Cord” was created, and aligned with The National Council for Agricultural Education’s (2015) Career Pathway Content Standards PST.01 (Apply physical science principles and engineering applications to solve problems and improve performance in AFNR power, structural and technical systems), PST.02 (Operate and maintain AFNR mechanical equipment and power systems), and PST.03 (Service and repair AFNR mechanical equipment and power systems). Lessons each included a full materials and resources list, intended student outcomes and learning objectives, an interest approach with guiding questions, a lecture with PowerPoints and student worksheets, a scripted demonstration with guiding questions, a student activity with guiding questions, and a summary activity. Lesson plans were evaluated for face and content validity by a panel of experts in teaching and learning and curriculum development within agricultural education. One researcher observed each instance of guest instruction to confirm fidelity of treatment, both within attire and the lesson delivery.

### **Instrumentation**

Following Morris et al.’s (1996) procedure for evaluating teacher attire, we used a combined instrument to measure students’ perceptions of teacher credibility and homophily between themselves and the teacher. Teacher credibility was evaluated via 15 items with five-point bipolar descriptors. Five constructs are related to teacher credibility, and each were evaluated with the following descriptors: *competence* (expert/inexpert, reliable/unreliable, qualified/unqualified), *character* (selfish/unselfish, kind/cruel, sympathetic/unsympathetic),

*sociability* (friendly/unfriendly, cheerful/gloomy, good-natured/irritable), *composure* (poised/nervous, relaxed/tense, calm/anxious), and *extroversion* (shy/outgoing, timid/bold, friendly/unfriendly) (Morris et al., 1996). Previous analysis of internal consistency within constructs yielded .85 for competence, .86 for character, .76 for sociability, .91 for composure, and .80 for extroversion.

The Measure of Perceived Homophily, which was developed by McCroskey, Richmond and Daly (1975) and updated in 1996 (McCroskey, McCroskey, & Richmond, 2007), was designed to measure perceived similarities between the source of information and the receiver (Rocca & McCroskey, 1999). The updated instrument measures three factors: attitude homophily, background homophily, and interpersonal attraction (McCroskey et al., 2007). Because of the necessity to maintain professional relationships between high school students and their teachers, we omitted questions related to interpersonal attraction from this study. Attitude homophily examines the perceived similarity between the attitudes of a source (in this case, the teacher) and a recipient (in this case, the student), and includes items such as, “This person shares my values.” Background homophily refers to the perceived similarity between the backgrounds between a source and a recipient, and includes items such as, “This person and I grew up in similar settings.” McCroskey et al.’s (2007) instrument included 17 items relating to attitude homophily and 10 items relating to background homophily. Their student-based tests of the instrument yielded internal consistency scores of .90 for attitude homophily and .84 for background homophily.

A panel of experts in agricultural education evaluated the combined instrument for face and content validity. Based on their recommendations, slight modifications were made to the attitude and background homophily scales to reduce respondent fatigue and eliminate items thought to be ambiguous or not applicable. The modified instrument yielded 10 items measuring attitude homophily and 7 items measuring background homophily.

A pilot test with 12 university freshmen was conducted to evaluate the validity and reliability of the combined instrument. Students were asked to view provided images of two individuals when completing the instrument. One image displayed a young, Caucasian male wearing jeans, a flannel shirt, boots, and a baseball hat while standing in a field, with his hands in his pockets. The other image displayed a young, Caucasian male wearing a large black jacket with a hood and sweatpants, gesturing aggressively to the camera, in a street with similarly dressed and mannered males behind him. The pilot test yielded internal consistency scores of .87 for attitude homophily and .88 for background homophily. Internal consistency scores for constructs within source credibility were as follows: .68 for competency, .95 for character, .77 for composure, .91 for extroversion, and .97 for sociability. Overall reliability for source credibility was .94. Divergent validity was calculated using dependent samples *t*-tests to assess perceived credibility and homophily between pilot test respondents and the individuals in the two provided images. Significant differences were found in all three areas; for attitude homophily,  $t(11) = 8.07, p < .005$ ; for background homophily,  $t(11) = 2.65, p = .023$ ; and for credibility,  $t(11) = 3.26, p = .008$ , indicating high construct validity within the instrument.

## **Data Collection and Analysis**

The instrument was administered to students via paper and pencil at the conclusion of each lesson. All sites yielded a 100% response rate. Data was analyzed via descriptive statistics, between treatment groups within each site. The magnitude of differences between groups were calculated and interpreted via effect sizes (Cohen, 1988).

### **Case A**

Case A included three Survey of Agriculture classes at a high school in a town of 35,000 residents. The high school teaches approximately 4,000 students in grades nine through 12. Within the two-teacher agriculture program, consisting of one male agriculture teacher in the final ten years of his teaching career and one female agriculture teacher in the middle of her teaching career, the Survey of Agriculture courses are taught by the female agriculture teacher. After random assignment of treatments to classes, the male guest instructor taught the “How does ice cream get to our table?” lesson in business professional attire to a class of 13 students, in business casual attire to a class of nine students, and in casual attire to a class of 15 students.

### **Case B**

Case B included two Survey of Agriculture classes and two Agricultural Mechanics classes at a high school in a town of approximately 3,200 residents. Approximately 600 students in grades nine through 12 are enrolled. The single-teacher SBAE program is led by a male agriculture teacher in the final five years of his teaching career. After random assignment of treatments to classes, the male guest instructor taught the “How does ice cream get to our table?” lesson in business professional attire to a Survey of Agriculture class of 11 students and in casual attire to a Survey of Agriculture class of 11 students. Additionally, the male guest instructor taught the “Repairing an extension cord” lesson in business professional attire to an Agricultural Mechanics class of 16 students and in casual attire to an Agricultural Mechanics class of 10 students.

### **Case C**

Case C included three Survey of Agriculture courses at a high school at the outskirts of a larger city of approximately 500,000 residents. The high school enrolls 533 students in grades 10 through 12. The two-teacher SBAE program is led by two male teachers, one in the middle of his teaching career and the other in the final 10 years of his career. After random assignment of treatments to classes, the female guest instructor taught the “How does ice cream get to our table?” lesson in business professional attire to a class of 13 students, in business casual attire to a class of 14 students, and in casual attire to a class of 13 students.

### **Case D**

Case D included two Food Science courses and two Survey of Agriculture courses at a high school serving a town of close to 2,500 residents. The high school enrolls approximately 400 students. The two-teacher SBAE program includes one female agriculture teacher entering the middle of her teaching career and one male agriculture teachers entering the final 10 years of his

teaching career. After random assignment of treatments to classes, the female guest instructor taught the “How does ice cream get to our table?” lesson in business professional attire to a Food Science class of six students and a Survey of Agriculture class of 10 students. She also taught the same lesson in casual attire to a Food Science class of 14 students and a Survey of Agriculture class of 25 students.

## Results

### Case A

Students experiencing the lesson wherein the guest instructor wore business professional attire reported the most favorable perceptions of the instructor’s credibility (Table 2). The guest instructor received the highest scores in attitude and background homophily from the group who saw him wear business casual attire. The instructor received the lowest scores in each area when dressed casually, but the difference between scores was as low as .01. Effect sizes were calculated via partial eta squared; the effect size for attitude homophily was .06, for background homophily was .02, and for credibility was .04. According to Cohen (1988), each of these effect sizes is negligible.

Table 2

*Mean Scores on Students’ Perceptions of Guest Instructors’ Attitude Homophily, Background Homophily, and Source Credibility for Each Treatment within Case A*

	Attitude Homophily	Background Homophily	Source Credibility
Business Professional	3.39	3.05	4.31
Business Casual	3.40	3.14	4.07
Casual	3.21	3.01	4.06

### Case B

#### *Agricultural Mechanics Classes*

Students experiencing the lesson when the guest instructor wore casual attire indicated higher attitude and background homophily with the instructor than those that engaged with the guest instructor while he wore business professional attire (Table 3). Additionally, the guest instructor was perceived as more credible when wearing casual attire than when wearing business professional attire. Effect sizes were calculated using Cohen’s *d*, attitude homophily and credibility yielded high effect sizes (Cohen, 1988), with scores being .79 and .93, respectively. Background homophily yielded a small effect size of .21.

Table 3

*Mean Scores on Students' Perceptions of Guest Instructors' Attitude Homophily, Background Homophily, and Source Credibility for Each Treatment within the Agricultural Mechanics Courses in Case B*

Attire	Attitude Homophily	Background Homophily	Source Credibility
Business Professional	2.73	3.01	3.71
Casual	3.45	3.10	4.38

### ***Survey of Agriculture Class***

Students experiencing the lesson when the guest instructor wore business professional attire indicated higher perceptions regarding attitude homophily, background homophily, and credibility of the instructor than did students experiencing the lesson with the casually dressed guest instructor (Table 4). Effect sizes were calculated using Cohen's *d*, and were negligible, with attitude homophily scoring .08, background homophily scoring .18, and credibility scoring .05.

Table 4

*Mean Scores on Students' Perceptions of Guest Instructors' Attitude Homophily, Background Homophily, and Source Credibility for Each Treatment within the Survey of Agriculture Courses in Case B*

Attire	Attitude Homophily	Background Homophily	Source Credibility
Business Professional	2.90	3.03	4.10
Casual	2.85	2.90	4.05

### **Case C**

Students experiencing the lesson when the instructor dressed in business casual attire noted highest perceptions on all three constructs (Table 5). The instructor received the lowest scores in both homophily constructs when dressed casually, but received the lowest source credibility scores when dressed in business professional attire. Effect sizes were calculated using partial eta squared; attitude homophily revealed a negligible effect size of .04, background homophily revealed a similarly negligible effect size of .09, and credibility revealed a slightly higher, yet still negligible effect size of .17.

Table 5

*Mean Scores on Students' Perceptions of Guest Instructors' Attitude Homophily, Background Homophily, and Source Credibility for Each Treatment in Case C*

Attire	Attitude Homophily	Background Homophily	Source Credibility
Business Professional	3.08	3.05	3.80
Business Casual	3.29	3.07	4.41
Casual	2.85	2.90	4.05



## Case D

Students experiencing the lesson when the guest instructor wore business professional attire reported highest perceptions of attitude homophily and source credibility (Table 6). However, students perceived the greatest background homophily with the guest instructor when she wore casual attire. Effect sizes were calculated using Cohen's *d*, and yielded small effect sizes for attitude homophily (.25) and credibility (.38), and a medium effect size for background homophily (.56).

Table 6

*Mean Scores on Students' Perceptions of Guest Instructors' Attitude Homophily, Background Homophily, and Source Credibility for Each Treatment in Case D*

Attire	Attitude Homophily	Background Homophily	Source Credibility
Business Professional	3.22	2.68	4.07
Casual	3.09	2.91	3.75

## Conclusions and Recommendations

Within Case A and C, the guest instructor received highest scores in both forms of homophily when dressed in business casual attire. Within Case C, he was also viewed as most credible when wearing business casual attire. However, within Case A, he was viewed as most credible when wearing business professional attire, which supports previous studies that concluded more professional attire led to increased student perceptions of teacher credibility (Butler & Roesel, 1989; Carr et al., 2009; Lukavsky et al., 1995; Morris et al., 1996).

Case B included two separate groups; one taught students about ice cream production in Survey of Agriculture Classes, while the other taught students how to repair extension cords in Agricultural Mechanics classes. While these students had the same background elements influencing their expectations of agriculture teachers, their perceptions of the same guest instructor were opposite one another. Agricultural Mechanics students perceived the guest instructor as most like them in both background and attitude and most credible when he was dressed in casual attire. Alternately, the Survey of Agriculture students perceived the guest instructor as most like them in both areas of homophily and most credible when he was dressed in business professional attire. These findings suggest that as occupational roles shift, so do students' expectations of agriculture teachers' attire (Workman & Freeburg, 2010). Gordon (2010) recommended that teachers dress in a manner that displays the teacher's ability and willingness to participate in occupational practices; the findings herein support this recommendation.

Case D was the only one wherein students' perceptions of the guest instructor's attitude and background homophily differed. Business professional attire yielded the highest attitude homophily scores, while casual dress yielded the highest background homophily scores. Perceptions of credibility were found to be highest among students engaging with the instructor when he was dressed in business professional attire. While these findings, in part, support those of previous studies associating high credibility with professional attire (Burler & Roesel, 1989;

Morris et al., 1996; Shoulders et al., 2017; Workman & Freeburg, 2010), students' differing perceptions of attitude and background homophily may imply that students feel they share similar values as the professionally-dressed agriculture teacher, but may not feel as though their backgrounds are like those of the credible agriculturalist. The theory of occupational aspirations posits that misalignment between one's self-concept and occupational image can cause elimination of the occupation as a career option (Gottfredson, 1981), suggesting these students may struggle to see themselves as capable of following in the occupational footsteps of their agriculture teacher.

Students perceptions in all three areas differed between cases, as did the effect sizes of each of the scores. These findings support the tenets of EVT; previous experiences with teachers in school based agricultural education programs shape students' perceptions of what a credible agriculture teacher looks like (Burgoon & Hale, 1988). Therefore, teachers should carefully consider their attire, as they play a role in shaping students' perceptions of those within AFNR careers. Further, their attire can influence whether students perceive AFNR occupations as compatible with their own concepts of self (Gottfredson, 1981).

When offered as an option, business casual attire produced highest scores most frequently. Additionally, business casual attire allows teachers to reach a "middle ground" between professional and casual attire, both of which have been shown to elicit negative perceptions among students in differing areas, and allows teachers to participate in the classroom responsibilities of the teacher as well as the occupational tasks of the agriculturalist. Lastly, business professional attire aligns with societal expectations of professional or scientific agricultural careers. These conclusions lead to our most definitive recommendation: SBAE teachers should dress in business casual attire when the educational situation allows. While specific lessons within agricultural contexts will require sartorial exceptions, business casual attire provides an avenue through which students can see themselves as professional agriculturalists and teachers can be perceived as credible, without one sacrificing the other. Finally, consistency among agriculture teacher dress can lead to higher, more consistent expectations regarding agriculture teachers as professional educators.

## References

- Barrick, M. R., Shaffer, J. A., & DeGrassi, S. W. (2009). What you see may not be what you get: Relationships among self-presentation tactics and ratings of interview and job performance. *The Journal of Applied Psychology, 94*(6), 1394–1411.
- Burgoon, J. K., & Hale, J. L. (1988). Nonverbal Expectancy Violations: Model Elaboration and Application to Immediacy Behaviors. *Communication Monographs, 55*, 58-79.
- Butler, S., & Roesel, K. (1989). The influence of dress on students' perceptions of teacher characteristics. *Clothing and Textiles Research Journal, 7*(3), 57-59.
- Carney, D., Colvin, C., & Hall, J. (2007). A thin slice perspective in the accuracy of first impressions. *Journal of Research in Personality, 41*(5), 1054-1072.
- Carr, D., Lavin, A., & Davies, T. (2009). The impact of business faculty attire on student perceptions and engagement. *Journal of College Teaching & Learning, 6*(1), 41-50.
- Coalition for a Sustainable Agricultural Workforce (CSAW) Executive Summary. (n.d.). Retrieved from: <https://www.crops.org/files/science-policy/testimony/csaw-executive-summary.pdf>
- Cohen, J. (1988). *Statistical power analysis for the behavioral sciences* (2<sup>nd</sup> ed.). Hillsdale, NJ: Lawrence Erlbaum Associates.
- DeLuca, S., Plank, S., & Estacion, A. (2006). Does career and technical education affect college enrollment? Columbus, OH: National Dissemination Center for Career and Technical Education.
- Dunbar, N. E., & Segrin, C. (2012). Clothing and Teacher Credibility: An Application of Expectancy Violations Theory. *ISRN Education, 2012*, 1-12. doi:10.5402/2012/140517
- Dyer, J. E., Breja, L. M., & Wittler, P. S. (2002). Predictors of student retention in colleges of agriculture. Proceedings of the 27th Annual National Agricultural Education Research Conference, 490-501.
- Gordon, H. (2010). Career and technical education administrators' perceptions of secondary teachers' attire as indicated by selected professional attributes. *Journal of Career and Technical Education, 25*(1), 47-61.
- Gottfredson, L. W. (1981). Circumscription and compromise: A developmental theory of occupational aspirations. *Journal of Counseling Psychology, 28*(6), 545-579. doi: 10.1037/0022-0167.28.6.545
- Himmelweit, H. T., Halsey, A. H., & Oppenheim, A. N. (1952). The views of adolescents on some aspects of the social class structure. *The British Journal of Sociology, 3*, 148-172.

- Lukavsky, J., Butler, S, & Harden, A. J. (1995). Perceptions of an instructor: Dress and students' characteristics. *Perceptual and Motor Skills*, 81, 231-240.
- McCroskey, L. L., McCroskey, J. C., & Richmond, V. P. (2007). Analysis and Improvement of the Measurement of Interpersonal Attraction and Homophily. *Communication Quarterly*, 54(1). 1-31.
- McCroskey, J. C., Richmond, V. P., & Daly, J. A. (1975). The development of a measure of perceived homophily in interpersonal communication. *Human Communication Research*, 1, 323-332.
- Morris, T. L., Gorham, J., Cohen, S. H., & Huffman, D. (1996). Fashion in the Classroom: Effects of Attire on Student Perceptions of Instructors in College Classes. *Communication Education*, 45(2). 135-148.
- National Academy of Sciences. (2009). *Transforming Agricultural Education for a Changing World*. Washington, DC: National Academies Press.
- Reiss, A. J. (1961). *Occupations and social status*. New York: Free Press.
- Roach, K. (1997). Effects of graduate teaching assistant attire on student learning, misbehaviors and ratings of instruction. *Communication Quarterly*, 45(3), 125-141.
- Roberts, T. G., Harder, A., & Brashears, M. T. (Eds). (2016). American Association for Agricultural Education national research agenda: 2016-2020. Gainesville, FL: Department of Agricultural Education and Communication. 29-48. Retrieved from: [http://aaaeonline.org/resources/Documents/AAAE\\_National\\_Research\\_Agenda\\_2016-2020.pdf](http://aaaeonline.org/resources/Documents/AAAE_National_Research_Agenda_2016-2020.pdf)
- Rocca, K. A., & McCroskey, J. C. (1999). The interrelationship of student ratings of instructors' immediacy, verbal aggressiveness, homophily, and interpersonal attraction. *Communication Education*, 48(4), 308-316. doi: 10.1080/03634529909379181.
- Shoulders, C. W., Sellick, S. A., Southward, L., & Blythe, J. M. (2017). An Exploration of How Attire Shapes High School Students' Perceptions of Agriculture Teachers. *Journal of Agricultural Education*. 58(2), 111-127. Doi: 10.5032/jae.2017.02111.
- Simmons, G. J. (1996). Teachers should dress for success. *Clearing House*, 69(5), 297-298.
- Simons, T. (1995). Interviewing job applicants: How to get beyond first impressions. *Cornell Hotel and Restaurant Administration Quarterly*, 36(6), 21-27.
- Smith, E. (2010). High school students' perceptions of agriculture and agricultural careers as delineated by presence of an agriculture program and rural/urban categorization. Unpublished undergraduate honors thesis, Cornell University.

STEM Food and Ag. Council (2014). *STEM Annual Report* (No. 1).

Terry, R., & Briers, G. (2010). Roles of the secondary agriculture teacher. In R. Torres, T. Kitchel, & A. Ball (Eds.), *Preparing and Advancing Teachers in Agricultural Education* (pp. 86-98). Columbus, Ohio: Curriculum Materials Service, The Ohio State University.

The National Council for Agricultural Education. (2015). Agriculture, food, and natural resources career cluster content standards. Retrieved from [https://www.ffa.org/sitecollectiondocuments/council\\_afnr\\_career\\_cluster\\_content\\_standards.pdf](https://www.ffa.org/sitecollectiondocuments/council_afnr_career_cluster_content_standards.pdf).

Workman, J. E. & Freeburg, B. W. (2010). Teacher Dress Codes in Employee Handbooks: An Analysis. *Journal of Family and Consumer Sciences*, 102(3), 9-15.

Yin, R. K. (2014). *Case Study Research: Design and Methods* (5<sup>th</sup> ed.). Thousand Oaks, CA: SAGE Publications.

## **Job Satisfaction of Agricultural Education Teachers in North Carolina**

R. Jason Davis, North Carolina State University  
James L. Flowers, North Carolina State University  
Wendy J. Warner, North Carolina State University  
David. W. Jones, North Carolina State University  
Gary E. Moore, North Carolina State University

### **Abstract**

Expansion of schools spawned by population growth and changes in the agricultural education curriculum have helped to increase the number of agricultural education programs and the need for agricultural education teachers in North Carolina. Lack of compensation and salary increases, along with public criticism of teachers have created a unique situation that warrants the investigation of the current levels of job satisfaction of North Carolina agricultural education teachers. Job satisfaction levels have been used as a predictor of an individual's decision to leave or end employment. The purpose of this study was to determine the overall levels of job satisfaction of teachers, to compare intrinsic and extrinsic job satisfaction levels, and to investigate relationships or differences between factors related to job satisfaction. This study used a descriptive research design. The instrument was developed by combining the Minnesota Satisfaction Questionnaire-MSQ short form with demographic variables to help determine the relationship between these variables and the level of job satisfaction of the respondents.

### **Introduction**

Job satisfaction is a complex phenomenon attributed to every vocation on earth (Aziri, 2011). Studies on job satisfaction are valued for both their humanistic and financial benefits (Worrell, 2004). Studies have examined the levels, determinants, and factors associated with levels of job satisfaction from every vocation ranging from nursing to sales, but more commonly in careers where high rates of attrition are common. These studies have all attempted to identify the factors associated with job satisfaction. When employees are satisfied, generally they care more about their work, are more committed, have higher retention rates, and are more productive (Bravendam Research Incorporated, 2002). Within the field of agricultural education, demands both in and out of the classroom have led many to question the level of job satisfaction among agricultural education teachers as a way to address issues facing the profession (Chenevey, Ewing, & Whittington, 2008).

Job satisfaction has been described in a variety of ways. Hoppock (1935) offered one of the earliest descriptions of the concept of job satisfaction. He described job satisfaction as any number of combinations of psychological, physiological, and environmental circumstances that produce an employee's positive feeling of his or her work. Smith, Kendall, and Hulin (1969) defined job satisfaction as simply a feeling an individual has about his or her job. Locke (1976) depicted job satisfaction as "the pleasurable emotional state resulting from the appraisal of one's job as achieving or facilitating the achievement of one's job values" (p. 1342). Vroom (1982) defined job satisfaction as a worker's emotional orientation toward current job roles in the

workplace. Spector (1997) viewed job satisfaction as “the extent to which people like (satisfaction) or dislike (dissatisfaction) their jobs” (p. 2).

The definition of job satisfaction has evolved, however one common thread has remained: all of these various definitions allude to the belief that job satisfaction is a work-related positive affective reaction (Worrell, 2004). Much like the definition of job satisfaction, varying opinions exist regarding the causes and factors associated with job satisfaction. Wexley and Yukl (1984) reported job satisfaction is the combination of many factors, including personal traits and job characteristics. The presence or absence of these factors could determine one’s job satisfaction level. These factors can be grouped into two categories: internal to the person (intrinsic) or external to the job (extrinsic). These levels have been strongly linked to job satisfaction and therefore warrant investigation (O’Driscoll & Randall, 1999). Examples of intrinsic factors may include recognition, advancement, and responsibility. Extrinsic factors, however, are external to the job such as salary and increased paperwork.

Previous research has concluded that agriculture teachers were fairly or moderately satisfied with their job (Flowers & Pepple, 1988; Grady, 1985; Jewell, Beavers, Malpeidi, & Flowers, 1990). Contrary to this finding, agriculture teachers commonly leave the profession within the first five years of teaching (Kantrovich, 2007). Teachers who leave the profession often attribute some degree of job dissatisfaction as their reason for leaving the profession (Flowers & Pepple, 1988). Teacher attrition is a common concern among the leadership in the profession, and many states work to fill agricultural teaching positions produced by growth and expansion in agricultural education programs, loss of current teachers, and shortages of agricultural education graduates (Camp, 2000). Furthermore, demands on teachers have changed. In the past ten years, educational reform, mandated testing programs, and budget cuts have all contributed to changes in the educational profession (Brown, 2016). In addition to changes in the profession, students, teaching practices, and societal influences are different than they were even a decade ago, therefore warranting a reinvestigation of the job satisfaction levels of agricultural teachers in North Carolina (Brown, 2016).

The supply of agricultural teachers compared to the demand is not only a North Carolina concern, but a national concern. The National Agricultural Education Supply and Demand Study of 2014 reported that there is an increased demand for new programs and additional teachers (Foster, Lawver, & Smith, 2015). The same study reported 7,424 school-based agricultural education programs, which employed 10,874 teachers. When the report was compiled in September of 2014, there were 1,366 new hires (Foster, et al, 2015). Despite this growth, 27 states reported a teacher deficit and not enough teachers available to fill positions, which resulted in the loss of 67 teaching positions and 45 programs.

While the teaching profession nationwide faces challenges, the teaching profession in North Carolina faces its own unique set of challenges. The media have shared that many teachers and the public have a negative perception of North Carolina public education, which has resulted in many teachers leaving the profession to pursue other opportunities (Scott & Smith, 2013). Over the past ten years, the state of North Carolina and its education system have experienced a tremendous amount of change. This change has come in the form of more technology, increased security, and increased standards and testing (Brown, 2016). The effects

of a growing population and a recession have decreased revenues for education. In many instances, this has resulted in less funding for textbooks, teacher assistants, extracurricular activities, and school supplies and more far reaching effects, such as increased class size.

In 1997, North Carolina worked to raise teacher salaries to the national average as part of a movement to increase the state's educational rankings (Hinchcliffe & Johnson, 2016). By 1999, North Carolina had increased teacher pay and was ranked 19th nationally. Within a few years, North Carolina's economy was slowed by an economic recession, cuts in federal funding, and lower state tax revenues. These factors resulted in a fall in the state's teachers' pay ranking to 47th nationally in 2013-2014 (Hinchcliffe & Johnson, 2016). In 2016, when salaries were adjusted for inflation, the average North Carolina teacher salary had decreased by more than 13% since 1999. The study found the average teacher salary in North Carolina is \$47,985, nearly \$10,000 below the national average of \$58,064 (Hinchcliffe & Johnson, 2016).

Many blame the state government of North Carolina's actions and its lack of investment in teaching (Brennan, 2015). In 2015, North Carolina initiated a proposal for a 7% pay increase for teachers; however, this raise did not impact the salaries of all teachers employed throughout the state. Instead, beginning teachers received the bulk of the raise, and more experienced teachers with more than 20 years of experience received little more than 1%. The North Carolina legislature, meanwhile, failed to raise teacher salaries for a number of years prior to 2015, removed incentives for master degree pay in 2013, attempted to end teacher tenure, and did not reinstate the teacher yearly increase in salary based on years of experience. These actions by North Carolina have all contributed to the perception of dissatisfaction among teachers within the state's education system (Brennan, 2015). One Texas school system has even attempted to capitalize on the dissatisfaction of North Carolina teachers by publicly recruiting North Carolina teachers by offering substantially higher salaries (Cassella, 2014).

Teachers have also borne the intense scrutiny and criticism of the public, reformers, and civic leaders. The negative attention has created a perception among the public that teachers are the sole source of students' low test scores and minimal achievement gains, and not the student, parental or community support (Wagoner, 2015). These critics often view the profession of teaching as teaching a few lessons, grading assessments, and taking long vacations. However, these perceptions are a misrepresentation of the profession, which is comprised of numerous additional duties outside of the actual act of teaching including; student afterschool activities, counseling, correspondence, meetings, additional training, and documentation (Sidebotham, 2015).

### **Purpose/Objectives**

A thorough examination of agricultural educators' job satisfaction levels has not been performed in North Carolina in 25 years. Since the last significant examination, the state's educational policy changes, increased teacher demands, and public perceptions have created a unique scenario, which warrants a timely examination of job satisfaction levels. These factors threaten the supply of teachers and the sustainability of the profession. As such, the purpose of this study was to investigate and describe the levels of intrinsic, extrinsic, and overall job satisfaction as measured by the Minnesota Satisfaction Questionnaire short form of North



Carolina high school agriculture teachers who taught in the spring of 2016 and remained in the teaching profession during the fall semester of 2016.

The research objectives for this study were to:

1. Investigate the level of intrinsic, extrinsic and overall job satisfaction of North Carolina high school agriculture teachers as measured by the Minnesota Satisfaction Questionnaire (MSQ) short form.
2. Examine the relationship between the intrinsic, extrinsic, and overall level of job satisfaction of North Carolina agriculture teachers and specific variables; salary, age, experience level in number of years in teaching, highest educational level completed, and the number of placement changes.

### **Theoretical Framework**

Research in the field of job satisfaction has been based on the theories of motivation (Aziri, 2011). The following theories lay a theoretical framework for this study: Maslow's hierarchy of needs theory (which proposed that needs and wants are the driving force of human interaction) and Herzberg's motivational-hygiene theory (which states that internal and external factors affect job satisfaction and that they can be measured). By determining and measuring the factors associated with agricultural teachers' job satisfaction, adjustments can be made to the work environment to increase satisfaction and decrease dissatisfaction.

Maslow (1943) saw human motivation in terms of needs that humans work to meet. Maslow believed people possessed a set of motivational systems unrelated to rewards or unconscious desires, which contrasted the philosophical theories of his day (Huitt, 2007). He theorized people were motivated by needs, which he grouped into tiers: physiological, safety, social, love, esteem, and growth (McLeod, 2014). The needs of each of these tiers ranged from the basic primal human needs of food and shelter to feeling loved and accepted. Maslow believed the desire to satisfy needs is what motivates human behavior. In Maslow's hierarchy of needs theory, human psychology is more than a mindless mechanism; it is a complex set of desires that change as needs are met or not met (Maslow, 1943).

Herzberg (1987) believed satisfaction was a complex interaction of people and perceptions in an effort to get someone to do something. Researchers have attempted to theorize what makes an individual satisfied with his or her job and to what point does dissatisfaction lead to a departure or decrease in productivity. Theorists in the study of job satisfaction have placed job satisfaction and dissatisfaction at opposite ends of the continuum or scale (Herzberg, 1968). An individual's gravitation toward either of these poles is determined by the presence or absence of factors in his or her working environment (Gruneberg, 1979).

Herzberg's motivation-hygiene theory attempts to explain how job satisfaction (or satisfiers) and job dissatisfaction (or maintenance factors) operate independently from one another because they are driven by different factors (Herzberg, et al., 1959). Herzberg believed that satisfaction and dissatisfaction are not on the same continuum and are therefore not opposites (Pardee, 1990). Motivators, or satisfiers, allude to the more intrinsic qualities of the job: challenge, accountability, recognition, advancement, growth, and responsibility. Hygiene

factors, or dissatisfiers, are the qualities that are linked to the environment of the job: pay, security, supervision, and physical working conditions (Herzberg, 1966). Motivational factors are those aspects of the job that make people want to perform. Factors associated with satisfaction and commonly attributed to motivation are achievement, recognition, and promotion. Herzberg theorized individuals are encouraged more by motivators than by maintenance factors.

As with Maslow's theories, higher level needs such as esteem and self-actualization correspond with Herzberg's motivator factors, and lower level needs like survival, safety, and social needs correspond with Herzberg's hygiene factors. Hygiene factors must be met to avoid dissatisfaction in the same way that Maslow's lower level needs are met before the motivator factors can lead to motivation and thus job satisfaction (Major, 2012). Herzberg suggested that motivator or intrinsic factors contributed to job satisfaction due to the employee's need for growth and self-actualization (Herzberg, 1966). Similarly, hygiene or extrinsic factors contribute to job dissatisfaction due to the individual's need to elude the negative.

### **Methodology**

This study used a descriptive research design. The study incorporated aspects of a quantitative exploratory survey research method as a snapshot in time of the perspectives of the respondents. The instrument for this study consisted of the Minnesota Satisfaction Questionnaire (MSQ) short form and demographic variables found in the literature that were believed to be associated with job satisfaction. The population frame of this study consisted of all high school agriculture teachers employed in North Carolina during the 2016-2017 school year teaching agriculture courses in the fall (N=370) and who were teaching in North Carolina in the spring semester of 2016. Newly hired teachers in the fall of 2016 were not included in the population because they had not been teaching long enough to assess their levels of job satisfaction at the time that data were collected. Names and contact information were obtained from the North Carolina agriculture teacher directory located on the North Carolina FFA website and verified by the state leaders in agricultural education. Efforts were made to eliminate all participants that did not meet the parameters of the population frame of this study. This population would be considered a sample of North Carolina agricultural teachers in time.

The Minnesota Satisfaction Questionnaire (MSQ) short form was utilized for the second portion of the questionnaire. This instrument was designed by Weiss, et al., (1967) through the Work Adjustment Project to address the adjustment problems relevant to vocational rehabilitation services. The instrument was developed to measure an employee's satisfaction with his or her job and the degree to which vocational needs and values are satisfied on the job. The instrument is gender neutral, may be administered to groups or individuals, and is written on a 5<sup>th</sup> grade reading level (Weiss, et al., 1967). The MSQ is a commonly used instrument to examine job satisfaction. Content validity of the instrument was assumed due to extensive use in the profession. The MSQ short form was also selected based on its ability to be given to individuals to determine an overall job satisfaction score, an intrinsic job satisfaction score, and an extrinsic job satisfaction score (Weiss, et al., 1967). Reliability coefficients of the MSQ short form ranges for various occupational groups were reported by Weiss, et al., (1967) at .84 to .91 for the intrinsic scale, .77 to .84 for the extrinsic scale, and .87 to .92 for the overall satisfaction scale.

The short form of the MSQ consists of 20 questions from the long-form that represent the intrinsic and extrinsic scales of the instrument (Minnesota Satisfaction Questionnaire, 2010). For each of the 20 questions on the MSQ portion of the survey, the developers of the MSQ provided the respondents a 5 point Likert type scale comprised of the following choices: *1-extremely satisfied, 2-very satisfied, 3-satisfied, 4-somewhat satisfied, and 5-not satisfied*. Higher levels of job satisfaction are typically associated with higher numeric values. Therefore, during the analysis of the data, these scores were reverse coded to provide higher numeric values for higher levels of job satisfaction. Factor Analysis of the 20 items results in three factors: intrinsic, extrinsic and overall satisfaction. Intrinsic satisfaction was measured by 13 of the 20 items, and the 7 remaining questions measured the extrinsic factors. All 20 items were used to measure overall satisfaction (Weiss, et al., 1967).

The questionnaire was distributed through an email message sent to high school agriculture teachers who were listed in the North Carolina Agricultural Education Directory and who had taught in the state the spring semester prior to this study and were teaching at the beginning of the school year (N=370). Five email addresses were returned as undeliverable. These five respondents were removed from the study, which yielded 365 accessible participants. The initial email message included a message asking for their participation in the study, a description of the purpose of the study, and a link to the questionnaire. The message also explained that when the participants click on the link to the questionnaire, they have agreed to participate in the study. The questionnaires were self-administered with directions stated on the first page of the instrument. The web-based system Qualtrics was utilized to collect data.

There were three attempts to obtain data from the population. The questionnaire was sent to respondents twice at one-week intervals. This resulted in a 50% response rate. After another week a third message was sent to non-respondents, resulting in 51 more responses, and a total of 234 responses for a final response rate of 64%.

Non-response error was addressed by comparing early and late respondents (Linder, Murphy, & Briers, 2001). Responses to the first two email messages (n=183) were classified as early respondents, and responses to the third and final email message were classified as late responses (n=51). Mean scores were compared on overall, intrinsic, and extrinsic job satisfaction for the early and late respondents. No difference was found between the early and late respondents on any of the scales; therefore, the results of the study can be generalized to the population of the study (Miller & Smith, 1983).

Data for this study were analyzed using the Statistical Package for Social Science-SPSS 24. Responses to the demographic questions in the survey were summarized using frequencies and percentages. Questions on the MSQ form were separated into intrinsic and extrinsic scales and summarized using mean scores and standard deviations.

## Findings

Participants' responses to items on the teacher profile section of the instrument were used to describe the population. The demographic characteristics examined in this study included: gender, ethnicity, age, educational level, entry method into teaching, marital status, income, teaching experience and number of placement changes from one school to another.

The educational level of the respondents of this study was almost evenly split between those with bachelor degrees 105 (46%) and those with master's degrees 117 (50%). The remaining 4% of teachers were divided between those who have obtained a 6<sup>th</sup> year certificate and those who have obtained a doctoral degree. The average number of years of teaching experience of the teachers in this study was 11.2 years (SD=9.1). The total years of teaching experience of the respondents ranged from 1 to 38 years. Almost half of the respondents (47%) had ten years or less of teaching experience, and the largest group (39%) were those with five years of experience or less. The mean number of placement changes of the respondents to this study is 1.04 (SD=1.26). The number of placement changes ranges from 0 to as many as 7 changes during the career of the teacher. The largest group, however, was the group of respondents with 0 placement changes (48%).

In general, the population for this study reflects the demographics of the agricultural educators of the state as a whole; predominately white and teaching in rural school settings. Almost half of the teachers were below the age of 34 (49%) with over half (54%) of the respondents having advanced degrees beyond a bachelor's degree.

This study focused on the intrinsic and extrinsic factors that North Carolina high school agricultural education teachers perceived about their present employment as measured by the Minnesota Job Satisfaction Questionnaire (MSQ) short form. Respondents were asked to report how satisfied they were with different aspects of their job. Teachers were asked to rate their level of job satisfaction for the 20 items on the MSQ short form. For the purpose of this study, the following interpretation scale was used: 1-1.50=Not Satisfied, 1.51-2.50=Somewhat Satisfied, 2.51-3.50=Satisfied, 3.51-4.50=Very Satisfied, 4.51-5=Extremely Satisfied. The respondents to this questionnaire averaged a mean intrinsic job satisfaction score of 4.16 (SD=0.52), which was classified as very satisfied. The respondents' mean extrinsic score was 3.26 (SD=0.84), which was classified as satisfied. The overall level of job satisfaction for the respondents to this survey was 3.83, which was classified as a very satisfied level of job satisfaction. Table 1 displays the 20 items of the MSQ short form, their mean scores, and standard deviation per each item, categorization as either intrinsic or extrinsic, and ranking from highest to lowest mean scores.

Table 1

*Intrinsic, Extrinsic & Overall Job Satisfaction Levels of North Carolina Agricultural Education Teachers*

<b>Intrinsic Job Satisfaction Items of the MSQ</b>	<b>Mean</b>	<b>Standard Deviation</b>
The chance to do things for other people	4.57	0.64
The way my job provides for steady employment	4.56	0.67
The chance to do different things from time to time	4.45	0.72
The chance to do something that makes use of my abilities	4.42	0.73
Being able to keep busy all the time	4.38	0.84
Being able to do things that don't go against my conscience	4.15	0.90
The chance to be "somebody" in the community	4.14	0.89
The chance to try my own methods doing this job	4.07	0.91
The feeling of accomplishment I get from the job	4.07	0.91
The chance to do work alone on the job	4.04	0.96
The way my co-workers get along with each other	3.88	1.08
The freedom to use my own judgment	3.82	1.03
The chance to tell people what to do	3.36	0.86
<b>Total Intrinsic Job Satisfaction</b>	<b>4.16</b>	<b>0.52</b>
<b>Extrinsic Job Satisfaction Items of the MSQ</b>		
The working conditions	3.79	1.13
The way my boss handles his/her workers	3.59	1.25
The competence of my supervisors in making decisions	3.55	1.24
The praise that I get for doing a good job	3.43	1.21
The way policies are put into practice	3.01	1.17
The chances for advancement at my job	2.83	1.07
My pay and the amount of work that I do	2.61	1.19
<b>Total Extrinsic Job Satisfaction</b>	<b>3.26</b>	<b>0.84</b>
<b>Overall Job Satisfaction</b>	<b>3.83</b>	

Note: 1="Not Satisfied", 2="Somewhat Satisfied", 3="Satisfied", 4="Very Satisfied", and 5="Extremely Satisfied"

Once sorted by mean scores, the intrinsic items' mean scores of the MSQ could be ranked into three subgroups: those that related to the nature of teaching, personal motivators, and management. Among the intrinsic factors, the items relating to the nature of the job of teaching ("The way my job provides for steady employment," "The chance to do different things from time to time," and "Being able to keep busy all the time") yielded the highest mean scores and were categorized as extremely satisfied and very satisfied. Personal motivators related to intrinsic job satisfaction such as "The chance to be somebody in the community" and the "Feeling of accomplishment I get from the job" received a very satisfied interpretation. Items "The chance to do work alone on the job" to "The chance to tell people what to do," were categorized as management type items. Although these items' mean scores were not as high as other items in the intrinsic category, they were still classified very satisfied to satisfied.

The seven remaining items of the MSQ measured the extrinsic level of job satisfaction for the respondents. The extrinsic items measured the respondents' attitudes and perceptions of pay, economic security, and tangible rewards. Items in the extrinsic category based on mean scores could be classified in two categories: those items that relate to administrative factors and those that relate to compensation. Those items that related to compensation received the lowest mean job satisfaction scores of the instrument. The respondents rated the extrinsic factors on the instrument lower than the intrinsic factors. Most of the items would be interpreted as satisfied, but not at the level of job satisfaction shown for the intrinsic items of the questionnaire. For the extrinsic factors, "The way my boss handles his or her worker," received the highest score with a mean score of 3.59 (SD=1.25). It should be noted 24% of the respondents ranked this item somewhat or not satisfied. The lowest mean score for any of the measures of the MSQ short form was "The pay for the amount of work that I do," which received a mean score of 2.61 (SD=1.19). For this item 54% of the participants were somewhat satisfied or unsatisfied as compared to 28% of the participants that ranked this item very or extremely satisfied.

The second objective of the study was to examine the relationship between the intrinsic, extrinsic, and overall level of job satisfaction of North Carolina agriculture teachers and specific variables; salary, age, experience level in number of years in teaching, highest educational level completed, and the number of placement changes. Table 2 displays the relationships between job satisfaction and selected demographic variables.

Table 2  
*Relationships Between Teacher Job Satisfaction and Selected Demographic Variables*

<b>Demographic Variable</b>	<b>Overall</b>	<b>Intrinsic</b>	<b>Extrinsic</b>
Years of Teaching Experience	.085	.164	-.019
	(p=0.207)	(p=0.015)	(p=0.784)
Age	-.022	.029	-.079
	(p=0.741)	(p=0.671)	(p=0.244)
Educational Level	.016	.041	-.015
	(p=0.816)	(p=0.543)	(p=0.822)
Placement Changes	-.138	-.066	-.201
	(p=0.042)	(p=0.335)	(p=0.003)

Teaching experience ( $r = .16$ ) was positively related to intrinsic job satisfaction ( $p=.015$ ), but the relationship was considered negligible (Davis, 1971). Further, this variable accounted for only 3% of the variance in intrinsic job satisfaction. As shown in Table 2, there were no statistically significant relationships between teaching experience, age of the teacher, and overall, intrinsic, and extrinsic job satisfaction levels. The number of placement changes or number of times that a teacher has changed school locations was related to job satisfaction for both overall ( $p = 0.042$ ) and extrinsic ( $p = 0.003$ ) job satisfaction. Overall job satisfaction was negatively related to teacher placement changes. As the number of placement changes increased, the job satisfaction level decreased. The relationship between job satisfaction and placement changes was also considered negligible (Davis, 1971). This variable accounted for less than 1% of the variance in extrinsic job satisfaction. There were no statistically significant relationships between the number of placement changes and intrinsic job satisfaction.

## Conclusions and Recommendations

Job satisfaction is not a problem for the agriculture teachers in North Carolina. The overall mean job satisfaction score generated by all of the items of the MSQ was 3.83, which was interpreted as very satisfied. Intrinsic items on the MSQ short form yielded a mean score of 4.16, which was interpreted as very satisfied. Extrinsic items on the questionnaire were rated slightly lower than intrinsic items. Extrinsic items resulted in a mean score of 3.26, which was interpreted as satisfied. Demographic variables do not explain variations in job satisfaction levels of North Carolina agricultural teachers. There were no reported significant relationships between salary, age, experience in years of teaching, highest educational level completed, or the number of placement changes. The listed variables do not explain the job satisfaction levels of the agriculture teachers.

Knowledge of the job satisfaction levels of agricultural teachers and the factors that attribute to these scores are beneficial on many levels. First, teachers that are satisfied with their current jobs provide better education for students. Research has shown that compensation and other hygiene factors are motivators to a point, but the intrinsic factors of being able to make decisions and recognition for teachers' work should be a priority to all administrators.

This study reported higher mean scores of intrinsic items on the questionnaire compared to the extrinsic items. Many of the extrinsic items such as compensation and administration are beyond the control of the teachers in this study and may not change for the foreseeable future. The findings of this study should be shared not only with state agricultural education staff and teacher educators, but also with education policy makers and school administrators. The agricultural education teachers in this study reported a very high level of overall job satisfaction; therefore North Carolina may be used as a model for other states addressing similar changes in growth, economics, and educational policies.

Based on the conclusions of this study there are several recommendations to strengthen research in agricultural education and job satisfaction. Firstly, a periodic assessment every 5 to 10 years of job satisfaction is necessary to determine the needs of teachers, increase satisfiers, and decrease dissatisfiers. Studies on job satisfaction should be periodically held to intelligently direct time, labor, and resources unless warranted by special events or a situational change. Secondly, this study was only a snapshot in time of job satisfaction of the respondents at a particular time. In the future, a longitudinal study of a group of teachers throughout their career should be conducted to determine changes in job satisfaction with age and tenure and to determine if there is a pattern to job satisfaction. Thirdly, the demographic variables used in this study were not strong predictors of intrinsic, extrinsic, and overall job satisfaction levels of agricultural teachers in North Carolina. Future research should look to other variables as potential predictors of job satisfaction such as: the total number of agricultural teachers at the school, number of children that the teacher has, the age of the children, extra workload required for school facilities such as livestock barns, greenhouses, and land labs, and the number of weekends spent working. Finally, future investigations into job satisfaction should also explore why some teachers leave the profession and others remain to determine if there are factors that affect teachers' decisions to leave.

## References

- Aziri, B. (2011). Job satisfaction: A literature review. *Management Research & Practice*, 3(4), 77-86. Retrieved 10-12, 2016 from: <http://mrp.ase.ro/no34/f7.pdf>
- Bravendam Research Incorporated (2002). Effective management through measurement: Special report. Retrieved 8-1, 2016 from: [www.employeesatisfactions.com](http://www.employeesatisfactions.com)
- Brennan, R. (2015). Teacher attrition continues to plague North Carolina. *Education Week*. Retrieved 8-1, 2016 from: [www.edweek.org](http://www.edweek.org)
- Brown, K. (2016). Carolina Curious: Public Education and Ten Years of Change. Retrieved 8-1, 2016 from: <http://www.wfdd.org/story/carolina-curious-public-education-and-ten-years-change>
- Camp, W. G. (2000). A National Study of the Supply and Demand Teachers of Agriculture Education in 1996-1998. Blacksburg, VA: Virginia Polytechnic Institute and State University.
- Cassella, M. (2014). Houston school district aiming to recruit North Carolina's teachers. *The Charlotte Observer*. Retrieved 4-12, 2016 from: <http://www.charlotteobserver.com/news/local/education/article9143855.html>
- Chenevey, J. L., Ewing, J. C., & Whittington, M. S. (2008). Teacher burnout and job satisfaction among agricultural education teachers. *Journal of Agricultural Education*, 49(3), 12-22.
- Davis, J. A. (1971). Elementary survey analysis. Prentice Hall: Englewood Cliffs, NY.
- Davis, K. & Newstrom, J. W. (1989). Human Behavior at work: Organizational behavior. (8<sup>th</sup> ed.) New York: McGraw Hill.
- Flowers, J. & Pepple, J. D. (1988). Assessment of the morale of beginning vocational agriculture teachers in Illinois. *Journal of the AATEA*, 29(2), 2-6.
- Foster, D., Lawver, R. G., & Smith, A. R. (2015). Ag Teacher Supply and Demand Overview. Retrieved 1-28, 2016 from: [www.naae.org/teachag](http://www.naae.org/teachag)
- Gruneberg, M.M. (1979) *Understanding job satisfaction*. Halsted Press.
- Herzberg, F. (1966). *Work and the nature of man*. New York: The World Publishing Company.
- Herzberg, F. (1987). *One more time: How do you motivate employees?* Harvard Business Review. September-October 1987, 5-16.
- Herzberg, F., Mausner, B., & Snyderman, B.B. (1959). *The motivation to work*. New York: John Wiley & Sons.



Hinchcliff, K., & Johnson, C. (2016). After inflation, N.C. Teacher pay has dropped 135 in the past 15 years. WRAL. Retrieved 9-16, 2016 from: [www.wral.com/after-nc-teacher-pay-has-dropped-13-in-past-15years.15624302/](http://www.wral.com/after-nc-teacher-pay-has-dropped-13-in-past-15years.15624302/)

Hoppock, R. (1935). *Job Satisfaction*. Oxford, England: Harper.

Huitt, W. (2007). Maslow's hierarchy of needs. *Educational Psychology Interactive*. Valdosta, GA: Valdosta State University. Retrieved 1-15, 2017 from: <http://www.edpsycinteractive.org/topics/regsys/maslow.html>

Jewell, L. R, Beavers III, K. C., Malpiedi, B. J., and Flowers, J. L. (1990). Relationships between levels of job satisfaction expressed by North Carolina vocational agriculture teachers and their perceptions toward the agricultural education teaching profession. *Journal of Agricultural Education*, 52-57. doi: 10.5032/jae1990.01052

Kantrovich, A. J. (2007). *A national study of the supply and demand for teachers of Agricultural Education: 2004-2006*. American Association of Agricultural Education. Retrieved 9-1, 2016 from: <https://www.naae.org/teachag/2007%20Supply%20Demand%20Study%20.pdf>

Linder, J. R., Murphy, T. H., & Briers, G. E. (2001). Handling nonresponse in social science research. *Journal of Agricultural Education*, 42(4), 43-53. doi: 10.5032/jae.2003.03078

Locke, E. A. (1976). The Nature and Causes of Job Satisfaction. *Handbook of Industrial and Organizational Psychology*, Rand McNally, pp. 1297-1350.

Major, A. E. (2012). Job design for special education teacher. *Current Issues in Education*. 15(2), 1-8.

Maslow, A. H. (1943). A theory of human motivation. *Psychological Review*, 50, 370-396.

Maslow, A. H. (1954). *Motivation and personality*. New York: Harper.

Maslow, A. H. (1970). *Motivation and personality* (2<sup>nd</sup> ed.) New York: Harper & Row.

McLeod, S. A. (2014). Maslow's Hierarchy of Needs. Retrieved 4-12, 2016 from: <http://www.simplypsychology.org/maslow.html>

Miller, L. E., & Smith, K.L. (1983). Handling non-response issues. *Journal of Extension*, 21(5). Retrieved 3-12, 2017 from: [www.joe.org/joe.1983september/83-5-a7.pdf](http://www.joe.org/joe.1983september/83-5-a7.pdf)

Minnesota Satisfaction Questionnaire (MSQ) (2010). Retrieved 1-12, 2016 from: [www.vpr.psych.umn.edu](http://www.vpr.psych.umn.edu)

- O'Driscoll, M. P., & Randall, D.M. (1999). Perceived organizational support, satisfaction with rewards, and employee job involvement and organizational commitment. *Applied Psychology: An International Review*, 48(2), 197-209.
- Pardee, R. L. (1990). Motivation Theories of Maslow, Herzberg, McGregor and McClelland-A Literature Review of Selected Theories Dealing with Job Satisfaction and Motivation. ERIC
- Scott, M. Swortzel, K.A., & Taylor, W.N. (2005). The relationship between selected demographic factors and the level of job satisfaction of extension agents. *Journal of Southern Agricultural Education Research*. 55(1), 102-115.
- Sidebotham, J. (2015). Here's What People Think Teachers Do All Day – And What They Actually Do. *Business Insider*. Retrieved 3-12, 2016 from: <http://www.businessinsider.com/heres-what-people-think-teachers-do-all-day-and-what-they-actually-do-2015-9>
- Smith, P. C., Kendall, L.M., & Hulin, C.L. (1969). *The measurement of satisfaction in work and retirement*. Chicago: Rand McNally.
- Spector, P. E. (1997). *Job Satisfaction: Application, assessment causes and consequences*. Thousand Oaks, CA: Sage Publications.
- Vroom, V. H. (1982). *Work and motivation* (Rev. ed). Malabar, FL: Robert E. Krieger Publishing Company.
- Wagoner, L. (2015) *Losing its Luster*. Retrieved from: [www.ncpolicywatch.com/2015/12/09losing-its-luster/](http://www.ncpolicywatch.com/2015/12/09losing-its-luster/)
- Weiss, D. J., Dawis, R.V., England, G.W., & Lofquist, L.H. (1967). *Manual for the Minnesota satisfaction questionnaire*. The work adjustment project. Industrial Relations Center. University of Minnesota. Retrieved from: [www.http://vpr.psych.umn.edu/assets/pdf/Monograph%20XXII%20-%20Manual%20for%20the%20MN%20Satisfaction%20Questionnaire.pdf](http://vpr.psych.umn.edu/assets/pdf/Monograph%20XXII%20-%20Manual%20for%20the%20MN%20Satisfaction%20Questionnaire.pdf)
- Wexley, K. & Yukl, G. (1984). *Organizational Behavior and Personnel Psychology*. Homewood, IL: Richard D. Irwin.
- Worrell, T. G. (2004). *School Psychologists' Job Satisfaction: Ten Years Later*. Unpublished Doctoral Dissertation. Virginia Polytechnic Institute and State University-Blacksburg VA. Retrieved from: <https://theses.lib.vt.edu/theses/available/etd-05252004-122551/unrestricted/Travidiss.pdf>

## **A Multi-State Evaluation of Secondary Agricultural Education Students' Performance on Industry-Based Standards**

Preston Byrd, Clemson University  
Stacy Vincent, University of Kentucky  
Joan Mazur, University of Kentucky  
Kang Namkoong, University of Kentucky

### **Introduction**

Once a student graduates and enters the workforce are they ready for the daily requirements of a job? Educational institutions have always strived to provide academic, technical, and employable skills to prepare students for careers after secondary education (Dibenedetto & Myers, 2016). The expectation of every student is to either enter the workforce or college, but how successful are the students once there? Per Lynch (2000), 50% of students in college fail to obtain a degree. Furthermore, students are entering the workforce with insufficient knowledge and skills needed to be productive workers (Gardner & Liu, 1997); thus, leading to collaborative work of industry leaders, educators, and policy makers to correct this unpreparedness of graduating students (Dibenedetto & Myers, 2016).

One method that has become more popular in the last decade has been the inclusion of industry-based certifications (IBCs) in career and technical education (CTE) (Wilcox, 2006). The premise behind IBCs is to ensure students have been adequately prepared for the current workforce. Many certifications exist that can be obtained through career and technical education courses and many companies offer the certification examinations (Foster & Pritz, 2006; Wilcox, 2006). One such organization that is used nationwide to create and administer the certification exams is the National Occupational Competency Testing Institute (NOCTI) (Foster & Pritz, 2006). NOCTI examinations have further added creditability by matching their test items to other national standards across the core academic areas such as math, science, and language arts. These certifications are based on several principles one which is quality. Quality of these certifications refer to how tightly aligned the certification is tied to industry standards which are highly valued by employers.

IBCs also utilizes an outside evaluation system to determine the level of skill and knowledge acquired according to the standardized skill and known objectives (Wilcox, 2006). The examinations which are based on industry standards are used to assess standards-based knowledge and associated skills. The IBCs helps educators create students that can meet an entry level industry standard upon graduation that can give students an edge in the job market and in turn makes the students more marketable to the industry (Foster & Pritz, 2006). According to Wilcox (2006), these credentials are nationally portable and not just tied to local industry.

Many states have started utilizing IBCs as the end of pathway examinations in career and technical education courses. Several states that have employed this technique is Virginia, Pennsylvania, Georgia, Texas, and Louisiana (Foster & Pritz, 2006, Wilcox, 2006). Several of

these states have used IBCs for juniors and seniors that do not express an interest in pursuing post-secondary education (Wilcox, 2006).

### **Theoretical Framework**

Over the last decade, industries and school infrastructures have pushed to use data-driven decision making to influence decisions within their respective institutions. Using data to drive decisions provides a quantifiable trail for decision makers to follow; an understanding of progress or regression in their fields. Data-driven decision making (DDDM) pertains to the systematic collection, analysis, examination, and interpretation of data to inform practice and policy in educational settings (Mandinach, 2012). Mandinach also states that, “It is no longer acceptable to simply use anecdotes, gut feelings, or opinions as the basis for decisions” (2012, p. 71). DDDM provides educators the opportunity to synthesize information provided by students in one form or another to improve classroom instruction and ultimately the educational performance of students (Wohlstetter, Datnow, & Park, 2008). In 2002, Kister, wrote about how CTE programs were starting to utilize NOCTI exam data in order to make improvements. Foster, Hodes, Kelley, and Pritz (2013) utilized DDDM methodologies in professional development events for CTE teachers so they could start utilizing the student data to make informed decisions for improving their programs.

DDDM has a continuum that allows data to be transformed and utilized to inform practice and policy. Along this continuum there are three levels data, information, and knowledge (Mandinach, 2012; Marsh, Pane, & Hamilton, 2006). The initial level of data is where individuals collect all the data in its raw form and organize it in some manner. In the information level, the organized data is given context to help glean different trends from the data so that performance can be summarized. In the final level, knowledge, the performance summaries are synthesized and prioritized to allow individuals to make decisions to impact practice and policy. According to Marsh et al, (2006) some of the possible decisions could address assessing progress toward goals such as a teacher assessing student performance to identify areas of remediation or to identify enhancements to improve outcomes within industry settings. Once the decisions have been implemented they will be examined to determine the impact which will start another reiteration of the DDDM process (Mandinach, 2012).



*Figure 1.* Data-Driven Decision Making model. This figure illustrates the elements of DDDM. College of Medicine Phoenix. (2017). Evaluation. Retrieved from <http://phoenixmed.arizona.edu/students/assessment/evaluation>

### **Purpose and Objectives**

The purpose of this study is to examine secondary agricultural education students’ accuracy to fabricate a Cost-effective Rollover Protective Structures based on industry standards set by the National Institute for Occupational Safety and Health (NIOSH), a branch of the Center for Disease Control. The study aligns with the American Association for Agricultural Education National Research Agenda Priority Area 3: Sufficient scientific and professional workforce that addresses the challenges of the 21<sup>st</sup> century (Roberts, Harder, & Brashears, 2016). From the purpose, the following objectives were created.

1. Based upon the industry-based standards set by NIOSH, describe the accuracy in the students’ assessment
2. Based upon the industry-based standards set by NIOSH, describe the weld accuracy in the students’ assessment.

### **Methods**

Secondary agricultural education students were assessed using industry-based standards through the process of fabricating a Cost-effective Roll-Over Protective Structure (CROPS) to be placed on a tractor within their community. The industry standard that was used as the basis of the assessment was the CROPS blueprints created and tested by mechanical engineers from the National Institute for Occupational Safety and Health (NIOSH) Division of Safety Research and Protective Technology Branch (NIOSH, 2016). The blueprints are in accordance with the Society of Automobile Engineers (SAE) industry standard performance test SAE J2194. There are four blueprints available on the NIOSH website which include the following tractor models: Ford 3000 series, Ford 4000 series, Ford 8N, and Massey Ferguson 135 series. Each blueprint has a list of tractor models within each series that the CROPS will fit.

Secondary agricultural education programs in three rural Appalachian states were selected due to the number of continued roll-over accidents with a total of 10 schools participating. The states included Kentucky, Tennessee, and North Carolina. Programs were selected through the help of recommendations by their respective state staff and/or university faculty. The requirements for recommendation included that the agricultural education program needed to have an agricultural mechanics laboratory and the agricultural educator needed to have a background in agricultural mechanics fabrication. The secondary teachers were then contacted to ascertain their interest in the project.

### **Participants**

The individuals creating the CROPS projects were the high school students under the supervision of their agricultural education teacher. Most of the agricultural education teachers utilized their entire class to fabricate the CROPS projects. During the 2015-2016 school year 11 CROPS projects were started with 10 fully completed and mounted on community tractors. There was one CROPS project that had all the required pieces cut out but was not completed but measurements were taken to evaluate piece specifications.

Table 1

<i>Frequencies of CROPS Fabricated by Tractor Model during the 2015-2016 School Year</i>	
<i>Tractor Model</i>	<i>f (%)</i>
Ford 3000 Series	4 (37%)
Ford 4000 Series	3 (27%)
Ford 8N Series	2 (18%)
Massey Ferguson 135 Series	2 (18%)

### **Preparation of teachers**

The researchers provided a three-day training prior to the start of secondary schools beginning. The purpose was for teachers to engage in the entirety of the curriculum as well as an immersion exercise in the laboratory, which served as the formative assessment of the state-mandated standards. One of the objectives from the three-day training was to assist the teachers in the fabrication and the standards prior to classroom implementation. Prior to the orientation, the secondary teachers sought farmers from their community whom own and utilize a tractor that is recognized as eligible for CROPS.

### **Curriculum Implementation**

During the school year, the secondary teachers were shipped all the base materials needed to fabricate the CROPS projects. The base materials included up to 20' sections of metal based on the model tractor CROPS blueprints being used, grade 5 and 8 bolts, flat and locking washers, and nuts. Upon completion of the CROPS projects, the agricultural educators would contact the research team to schedule an inspection. The assessment of the students' abilities to perform at

an entry level industry standard was conducted by an outside evaluator. The outside evaluator was an agricultural mechanics professor with a background in inspecting agricultural mechanics fabrication projects and visually inspecting welds.

## Instrumentation

The evaluator utilized the CROPS blueprints to create an instrument served to evaluate the students' ability to accurately fabricate the CROPS in accordance to NIOSH's industry-based standards. Based upon the project constructs, established by engineers, the components were divided into three separate sections: axel mounting components (part numbers 1, 2, 3, 4, 5, and 7), vertical support components (part numbers 6, 8, 9, 10, and 11), and welded components (part number 12) for inspection and reporting purposes (for a visual of part numbers, see Figure 1).

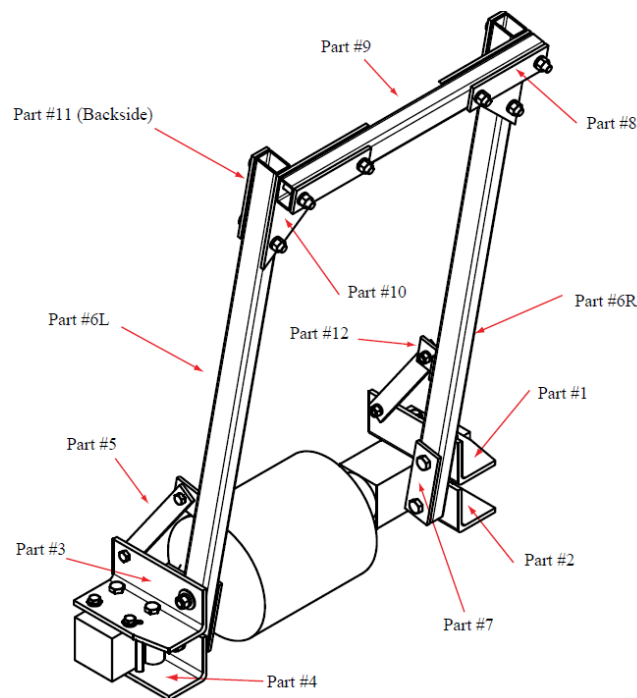

*Figure 1.* Ford 3000 Series drawing of completed CROPS project. Adapted from the blueprints for Cost-effective Rollover Protective Structure (CROPS) for Wheeled Agricultural Tractors Ford 3000 series Technical Drawings retrieved from: <https://www.cdc.gov/niosh/topics/aginjury/crops/pdfs/ford-3000/Ford-3000-Technical-Drawings.pdf>

The inspection factors included correct overall measurement of the piece being fabricated, correct placement of drilled holes, correct placement of a welded bracket, visual inspection of welds, and correct torque applied to mounting bolts. The checklist was broken down by 1/16" increments from  $>1/4$ ,  $>3/16$   $<1/4$ ",  $>1/8$   $<3/16$ ",  $>1/16$   $<1/8$ ",  $<1/16$ " to evaluate the overall measurement of the CROPS pieces, placement of drilled holes, and the welded bracket. The largest increment off from the blueprints was marked. Like industry standards if one part of a component is off the whole component would be rejected. The wrong

placement of drilled holes and welded brackets were grounds for having a piece fixed or have a new piece fabricated.

Visual inspection of the welds looked for any discontinuities and utilizing a fillet gauge to measure leg length and face fill. The welds must have leg lengths of at least 3/16” to pass inspection and be the full length of the piece. Welds were also inspected for visual discontinuities such as porosity, undercut, and lack of fusion. Dependent on the size of the discontinuity present the weld could not meet the industry-based standard. The bolt torque was checked with an appropriate torque wrench. For parts that had to be refabricated or rewelded programs either completed the task the day of inspection or the evaluator came back after the piece(s) were fixed to the standard set; however the results of this study is based upon the initial findings.

### Results

Objective one sought to describe the students’ abilities to fabricate the CROPS based on the industry standard of the related NIOSH blueprints. The results are broken up into three sections including axel mounting components, vertical support components, and welded components. Overall, most mistakes in fabrication of the CROPS projects were found within the axel mounting components. It was found that the parts with the least amount of fabrication needed were the most accurately made by the secondary agricultural education students. Table 2 illustrates the abilities of students to fabricate the axel mounting components.

Table 2

*Inspection Frequencies and Percentages of the Axel Mounting Components (N = 11)*

Part	>1/4”	>3/16” <1/4”	>1/8” <3/16”	>1/16” <1/8”	Correct
	f(%)	f(%)	f(%)	f(%)	f(%)
Top Right Axel Bracket					
- Piece Specification	1 (9%)	1 (9%)	2 (18%)		6 (54%)
- Hole Placement	1 (9%)		2 (18%)	2 (18%)	4 (36%)
Bottom Right Axel Bracket					
- Piece Specification		1 (9%)	3 (27%)		5 (45%)
- Hole Placement	1 (9%)	1 (9%)		3 (27%)	4 (36%)
Top Left Axel Bracket					
- Piece Specification	2 (18%)		1 (9%)	1 (9%)	6 (54%)
- Hole Placement	1 (9%)		3 (27%)		5 (45%)
Bottom Left Axel Bracket					
- Piece Specification	2 (18%)		3 (27%)	1 (9%)	4 (36%)
- Hole Placement				4 (36%)	5 (45%)



Vertical Tube Bolted Brace			
- Piece Specification	1 (9%)	1 (9%)	9 (82%)
- Hole Placement	1 (9%)	2 (18%)	7 (64%)
Right Bottom Vertical Tube Backing Plate			
- Piece Specification		2 (18%)	8 (72%)
- Hole Placement		3 (27%)	6 (54%)
Left Bottom Vertical Tube Backing Plate			
- Piece Specification		2 (18%)	8 (72%)
- Hole Placement		3 (27%)	6 (54%)

*Note:* N = 11. Not all projects were completed at the time of inspection, frequencies of each piece may not equal 11.

Within the vertical support components, the most variation of accuracy can be seen with the crossbar and corner plates. The most accurately made pieces within the vertical support components were the right and left vertical tubes. Most of the parts were within 1/8" accuracy of the NIOSH blueprints. The accuracy frequencies for the vertical support components can be seen in Table 3.

Table 3

*Inspection Frequencies and Percentages of the Vertical Support Components (N = 11)*

Part	>1/4"	>3/16" - <1/4"	>1/8" - <3/16"	>1/16" - <1/8"	Correct
	f(%)	f(%)	f(%)	f(%)	f(%)
Right Vertical Tube					
- Piece Specification				1 (9%)	10 (91%)
- Hole Placement				4 (36%)	6 (54%)
Left Vertical Tube					
- Piece Specification			1 (9%)	1 (9%)	9 (81%)
- Hole Placement				4 (36%)	6 (54%)
Right Crossbar Backing Plate					
- Piece Specification				2 (18%)	9 (81%)
- Hole Placement			2 (18%)	2 (18%)	6 (54%)
Left Crossbar Backing Plate					
- Piece Specification		1 (9%)		2 (18%)	8 (72%)
- Hole Placement		1 (9%)	1 (9%)	1 (9%)	7 (63%)
Crossbar					
- Piece Specification				4 (36%)	6 (54%)
- Hole Placement	1 (9%)		3 (27%)	1 (9%)	5 (45%)

Right Corner Plate				
- Piece Specification		1 (9%)		9 (81%)
- Hole Placement	2 (18%)			8 (73%)
Left Corner Plate				
- Piece Specification	2 (18%)	1 (9%)		9 (81%)
- Hole Placement			1 (9%)	7 (64%)
Top Vertical Backing Plate				
- Piece Specification	1 (9%)			9 (81%)
- Hole Placement	1 (9%)		2 (18%)	6 (54%)

Note:  $n = 11$ . Not all projects were completed at the time of inspection, frequencies of each piece may not equal 11.

The third objective sought to examine the students' ability to accurately weld the necessary components together, as set by the industry-based standard. There are four fillet welds (tee position) that must be completed on the CROPS project for a total of 44 weld inspections. These welds must be continuous (one solid bead) and have leg lengths of at least 3/16". There were two welds (4.54%) identified as unacceptable and were reconstructed because of the inaccuracy of the brace. All but one of the pieces were fabricated within 3/16" accuracy and all welds passed visual inspection. Frequencies and percentages of the inspection of the welded components, as set by the NIOSH approved industry standard, can be seen in Table 4.

Table 4

Part	>1/4"	>3/16"	>1/8"	>1/16"	<1/16"	Passed Inspection
	$f(\%)$	<1/4"	<3/16"	<1/8"	$f(\%)$	
Right Vertical Tube Brace						
- Piece Specification	1		1 (9%)	1 (9%)	7 (64%)	
- Hole Placement	(9%)			3	7 (64%)	
				(27%)		
Left Vertical Tube Brace						
- Piece Specification			1 (9%)	1 (9%)	8 (72%)	
- Hole Placement				3	7 (64%)	
				(27%)		
Right Vertical Tube Welds						
- Weld Size and length			3	2	3 (27%)	
- Inspection Result			(27%)	(18%)		8 (100%)
Left Vertical Tube Welds						
- Weld Size and length			2	3	3 (27%)	
- Inspection Result			(18%)	(27%)		8 (100%)

Note:  $n = 11$ . Not all projects were completed at the time of inspection, frequencies of each piece may not equal 11

## **Conclusions, Discussion, and Recommendations**

This study is part of a multi-state grant through the Southeast Center for Agricultural Safety and Injury Prevention. All of the schools selected had a pre-trained secondary agriculture teacher approved to teach the curriculum and identified as proficient in agriculture mechanics education. Each school successfully fabricated 1-2 CROPS for their community and most met the components of the CROPS project to the industry standard put forth by the NIOSH blueprints on their first attempt.

When it comes the three areas of the evaluation, the axel mounting brackets were the components where the most variation in the results occurred. The mounting brackets entail a variety of drill points, cuts, and designated tapped holes making the section the most complex pieces to fabricate. Based upon Data-Driven Decision Making (Mandinach, 2012), the conclusions infer that teachers will need to make informed changes so that the desired level of accuracy is met. With all the requirements of the piece if an individual is not conscientious and diligent in being precise with their work it is easy to make a mistake. It is recommended for programs to allow students to work on sample pieces before cutting pieces for the final product. So that the final product is closer to the industry standard when fabricating the project. This may lead to students being more detail oriented in the overall CROPS fabrication process. Future research needs to examine if this project creates a change on a student's ability to pay attention to detail so that fabrication accuracy is achieved. Based on DDDM, the summer training of teachers should include more emphasis on accuracy and possible methods of improving student accuracy.

It can be concluded that the majority of participating schools had the highest accuracy when fabricating the right and left vertical tubes, which is the largest piece fabricated. One reason this these parts have the highest accuracy is because they require minimal steps to complete. The vertical tubes require the drilling of eight holes and only one cut. The holes being drilled for these pieces are to allow a bolt to pass through the entire piece. Based on DDDM, teachers are ensuring that the vertical tubes are fabricated accurately and need to focus on pieces that need more accuracy, such as the axel brackets. It is recommended that students maintain the same level of accuracy they have when fabricating the vertical tubes with the rest of CROPS project so that all pieces are accurate. Summer training should include more emphasis on pieces that are not being fabricating accurately so that teachers will emphasize the need of accuracy on those pieces as well with their students.

Teachers should be fluent in the fabrication procedure and should allow students pieces to practice on before fabricating a final product. This could mimic the initial training employees would receive at the onset of obtaining an industry related job. After the analyzation of data the next step in DDDM is to improve and plan for new methods to implement to improve accuracy. One recommendation is that teachers should implement an internal inspection procedure throughout the fabrication process to ensure pieces and hole placements are accurate. This would also mimic how an industry would monitor manufacturing lines. Since programs are only

completing one or two projects at most implementing the steps that industry use in manufacturing may allow students to become better equipped for the workforce just as IBCs do according to Foster and Pritz (2006).

The CROPS project was designed to be bolted together so that the structure is not rigid but would have movement in the event of a roll-over. With this design there are only four welds that must be completed and they are to mount the bracket that attached a brace from the axel bracket to the vertical tubes. The required weld is a simple fillet weld that must go the full length of the bracket in one pass. It can be concluded that the required welds were an area that needs improvement. Only 27% of the welds were the correct length but were still able to pass the visual inspection. There were a couple of occasions where welds had to be ground off and re-done. This was not because of any flaw or length inaccuracies, but was due to the bracket being welded in the wrong place. The main reason of the brackets being welded in the wrong place was because the program was completing more than one CROPS project but for two different model tractors. Based upon DDDM, it is recommended that teachers double check placement of the welded bracket prior to welding it in place. Furthermore, trainers need to further explain that the placement of the welded bracket is different between the different models tractors.

Visual inspection of the fillet welds can only verify what can be seen on the outside. Following the stages of DDDM this is an area where the inspection procedure could improve. For this reason it is recommended to include a method of evaluation for the welds on the CROPS project to further validate the structural integrity of each weld. Since the projects are to be installed on a tractor upon completion destructive testing is not an option. Therefore, methods of non-destructive testing would be the only option such as Ultrasonic Testing or X-ray evaluation techniques. Researchers also recommend continuing the project to further validate this study's findings that secondary agricultural education students can fabricate a project to industry standards.

## References

- DiBenedetto, C. A., & Meyers, B. E. (2016). A Conceptual Model for the Study of Student Readiness in the 21<sup>st</sup> Century. *NACTA Journal*, 60(1a), 28-35.
- Foster, J. C., & Pritz, S. G. (2006). The Certification Advantage. *Techniques: Connecting Education and Careers*, 81(1), 14-20.
- Foster, J. C., Hodes, C. L., Kelley, P., & Pritz, S. G. (2013). Professional development in CTE data driven methods: Development of a research-based intervention. *Online Journal for Workforce Education and Development*, 5(1). Retrieved from <http://opensiuc.lib.siu.edu/ojwed/vol6/iss1/>
- Gardner, P. D., & Liu, W. Y. (1997). Prepared to perform? Employers rate work force readiness of new grads. *Journal of Career Planning and Employment*, 57(3), 32-56.
- Kister, J. (2002). Using standardized test data to improve instruction in career-technical education (NOCTI White Paper). Bronson, MI: NOCTI.
- Lynch, R. L. (2000). High school career and technical education for the decade of the 21<sup>st</sup> century. *Journal of Vocational Education Research*, 25(2), 155-198.
- Mandinach, E. B. (2012). A Perfect Time for Data Use: Using DataDriven Decision Making to Inform Practice, *Educational Psychologist*, 47(2), 71-85. doi: 10.1080/00461520.2012.667064
- Marsh, J. A., Pane, J. F., & Hamilton, L. S. (2006). Making Sense of Data-Driven Decision Making in Education: Evidence from Recent RAND Research. Santa Monica, CA: RAND Corporation. Retrieved from [https://www.rand.org/pubs/occasional\\_papers/OP170.html](https://www.rand.org/pubs/occasional_papers/OP170.html).
- National Institute for Occupational Safety and Health (NIOSH). (2016). Agricultural Safety. Retrieved from: <https://www.cdc.gov/niosh/topics/aginjury/crops/>
- Roberts, T. G., Harder, A., & Brashears, M. T. (Eds). (2016). *American Association for Agricultural Education national research agenda: 2016-2020*. Gainesville, FL: Department of Agricultural Education and Communication.
- Wilcox, D. (2006) The Role of Industry Based Certifications in Career and Technical Education. *Techniques: Connecting Education and Careers*, 81(1), 21-23.
- Wohlstetter, P., Datnow, A., & Park, V. (2008). Creating a system for data-driven decision-making: applying the principal-agent framework. *School Effectiveness and School Improvement*, 19(3), 239-259. Retrieved February 13, 2017. doi: 10.1080/09243450802246376

# **Comparative Analysis of Students Taught Science or Agriscience: Results on State Standardized Reading Assessment**

Anna J. Warner, University of Florida  
Andrew C. Thoron, University of Florida  
Glen D. Israel, University of Florida

## **Abstract**

An increased demand for literacy in today's information rich society has caused education initiatives requiring content area teachers to develop discipline literacy. While research has shown increased performance and achievement of agriscience students in math and science, little research on reading achievement of these students is available. This study relied on contextualized learning and status attainment theories as the basis of this descriptive logistical regression. It investigated the relationship between 8<sup>th</sup> grade students enrolled in a high school level Agriscience Foundations course for science credit and reading achievement test scores. The findings support the status attainment theory by identifying variables which distinguished hierarchy of enrollment and achievement. Students enrolled in Agricultural Foundations outperformed basic science students and scored equivalently or slightly lower than advanced science students. Schools should consider the association of agriscience courses on achievement when considering course offerings.

## **Introduction**

The increase in information-based technology and changes in the workplace have made the literacy requirements of adolescents entering adulthood higher in the 21<sup>st</sup> century than at any other time in history (Shanahan & Shanahan, 2008; Vacca & Vacca, 2005). These young people will rely on their literacy skills for economic and social responsibilities, such as job performance, household management, societal participation, and personal pursuits. Historically, educators made only slight advancement in increasing reading skills of students and building their capacity for comprehension and application of text (Cappella & Weinstein, 2001; Snow, 2002). Recent initiatives in education have spread the responsibility for literacy across the school and focused on how secondary content area teachers can develop the discipline literacy of their students (Chapman, 2015). Integration of literacy skills in Career and Technical Education (CTE) courses has increased the vocabulary and comprehension of students (Park, Pearson, & Richardson, 2017). The new Common Core State Standards adopted by Florida in 2014 include reading standards for literacy within content areas (Florida Department of Education [FDOE], 2014). Lester (2000) linked the success of students in developing their literacy skills to the decisions of teachers to make literacy a central part of their instructional planning.

Development of educational policy and practices in the United States (U.S.) relies greatly on standardized testing to measure student achievement in order to set educational policy and practices, in spite of questions surrounding the validity and meaning of those test scores (Israel & Beaulieu, 2004). American students have consistently performed below the international average on achievement tests regardless of efforts to increase student achievement with more demanding standards and testing (FDOE, 2015a; Israel & Beaulieu, 2004; United States Department of Education [USDE], 2016). The Condition of Education 2015 report compared previous achievement levels of students to current levels to trace progress (USDE, 2016). Only 36% of 8<sup>th</sup>

grade students performed at or above the *Proficient* level for reading in 2013, a 2% increase from 2011 and a 7% increase from 1992. Females have consistently scored higher than males. White students scored at least 20 points higher than Black, Hispanic, and American Indians/Alaskan Native students and four points lower than Asian/Pacific Islander students. According to the Program for International Student Assessment (PISA), American students are scoring below the international average in math and science and only two points above the international average in reading (USDE, 2015). In 2012, the U. S. ranked 24 out of 65 in reading literacy. Florida students scored lower than the international and national students.

The Florida Comprehensive Assessment Test (FCAT) was implemented in 1988 to measure mathematics, reading, science, and writing achievement of students based on the Sunshine State Standards (FDOE, 2015a). With the development of the Next Generation Sunshine State Standards (NGSSS), the state transitioned to the FCAT 2 tests during the 2010-2011 school year (FDOE, 2015a; FDOE, 2015b). FCAT scores rank student into one of five levels (see Table 1; FDOE, 2009; FDOE, 2015a; FDOE, 2015b; FDOE, 2015d). Scoring at Level 3 or higher constitutes a passing grade for these tests.

Table 1.  
FCAT 2.0 Score Levels.

Score Level	Level of success with the challenging content of the NGSSS
1	Inadequate
2	Below satisfactory
3	Satisfactory
4	Above satisfactory
5	Mastery of the most challenging content

(FDOE, 2015b; FDOE, 2015d)

### Theoretical Framework & Literature Review

This study was guided by contextualized learning (Buriak, McNurlen, & Harper, 1996; Dworkin, 1959; Fosnot, 1996; Piaget, 1976; Vygotsky, 1962) and status attainment (Duncan, Featherman, & Duncan, 1972; Wilson & Portes, 1975) theories.

#### Contextualized Learning

Contextualized learning falls under the constructivism learning theory, which proposes that knowledge is created by the learner through experiences (Doolittle & Camp, 1999; Piaget, 1976; Vygotsky, 1962). The environment is paramount to knowledge construction as it cannot be separated from society and culture (Vygotsky, 1962). The theory suggests that learners require authentic examples and experiences they can use to construct their own meaning, models, concepts, and strategies (Dworkin, 1959; Fosnot, 1996; Haury & Rillero, 1994) and that learners should apply their knowledge in multiple, diverse settings (Buriak et al., 1996).

The integration of core academic content in CTE courses is required by the Carl Perkins Act, thus making CTE a model for teaching academic and transferable skills required for career success (Meeder & Suddreth, 2012). Teachers play a role in the reading achievement of students (Forget & Bottoms, 2000; Lester 2000; Park & Osborne, 2007). Agriscience teachers' pedagogical competence and agricultural technical knowledge were significant predictors of their competence in integrating reading into their coursework (McKim, Sorensen, & Velez, 2016). Additionally, Park and Osborne (2007) noted that context also played a role in reading

comprehension of agriscience students. Integrating disciplinary reading strategies into agricultural education is critical in developing student competencies and increasing reading comprehension (Park, van der Mandele, & Welch, 2010). Through a series of interviews with agriscience teachers, Park and colleagues (2010) found that these teachers believed in the importance of reading for future success and viewed it as supplemental to their agricultural science classes. Additionally, instead of using explicit instruction and reading, these teachers embedded disciplinary reading into their courses where they used authentic texts to activate background knowledge and expected students to “*read in order to apply*” (emphasis in original) what they have read to hands-on activities (p. 108).

Researchers have found students who have completed CTE courses to be successful in the academic areas of science and mathematics (Chiasson & Burnett, 2001; Conroy, Trumbull, & Johnson, 1999; Israel, Myers, Lamm, & Galindo-Gonzalez, 2012; Meeder & Suddreth, 2012; Shinn et al., 2003; Stripling & Roberts, 2012; Warner, Thoron, & Israel, 2017a, 2017b). Students who were enrolled in agriscience foundations course for their eighth-grade science credit, outperformed students who took basic science and equivalent to slightly lower than student in advanced science on their science and math FCAT and FCAT2 achievement scores (Warner et al., 2017a, 2017b). However, limited research has explored the effects of agriscience education on reading achievement (Park & Osborne, 2005, 2007). Park and Osborne (2007) highlighted the need for research to address how “the context of agriscience impact[s] student reading achievement and comprehension” (p. 25).

### **Status Attainment Theory**

An individual’s place in educational hierarchies is determined by socioeconomic status, inborn ability, and mediating factors, such as ambitions, according to the status attainment theory (Wilson & Portes, 1975). More than forty years of research has found that socioeconomic status, race, ethnicity and other background variables strongly impact educational achievement (Darling-Hammond, 2000; Haller & Porter, 1973; Israel et al., 2012; Portes & MacLeod, 1996; Wilson & Portes, 1975). The significance of student-level variables on achievement was highlighted by hierarchical linear models created by Israel et al. (2012). Thus, the role of student-level variables must be considered when investigating the effects that contextualized learning in agricultural education has on the reading achievement of students.

Israel and Beaulieu (2004) found numerous significant predictors of math, reading, and math/reading composite scores for 8<sup>th</sup> grade students. Predictors with positive relationships to student achievement scores included: being classified as gifted, higher average grade composite, completed Algebra 1, student engagement in class, and hours doing homework. Predictors with negative relationships to student achievement scores included: Black and Hispanic ethnic groups, being female, being a disruptive student, and students with attendance issues. Family, school, and community resources as well as school and community structure and social capital predictors were also predictors above the individual student level. “The contextual aspects of school and community structure mediated the influence of family social capital, student ability, and background on student achievement” (Israel & Beaulieu, 2004, p.283).

Israel and Beaulieu (2004) have identified predictors of student achievement on 8<sup>th</sup> grade standardized tests in reading and math. Additionally, researchers have examined the impact of agricultural enrollment on science and math achievement at the high school level (Bunch et al., 2014; Chiasson & Burnett, 2001; Conroy, Trumbull, & Johnson, 1999; Israel, et al., 2012; Nolin



& Parr, 2013; Parr et al, 2006; Parr et al, 2008; Parr et al, 2009; Shinn et al., 2003; Stripling & Roberts, 2012). However, research investigating the impact of agricultural coursework on student reading achievement at the middle school level has not been found.

### **Purpose of the Study**

The purpose of this study was to determine if student enrollment in Agriscience Foundations as a science credit during the 8<sup>th</sup> grade year was associated with increased reading FCAT scores of 8<sup>th</sup> grade students. The following objectives guided the study:

1. Describe the characteristics of the populations of Agriscience Foundations students, Basic Physical Science Students, and Advanced Physical Science students.
2. Determine if students enrolled in the Agriscience Foundations course as a science credit score higher on FCAT reading tests than those students enrolled in a science course.
3. Ascertain what factors predict student's achievement on FCAT reading tests.
4. Analyze how the level of the course taken for science credit is related to FCAT reading achievement levels.

### **Methodology**

This study used a quantitative, descriptive logistical regression research design which permitted the use of categorical data provided by the data set to predict categorical outcomes (Field, 2013; Lomax & Hahs-Vaughm, 2015; Keith, 2015). The population of interest was 8th grade students in Florida. A north-central county school district served as a convenience sample for this populations because it was the only county school system offering the Agriscience Foundations course to 8th graders for science credit. The generalizability of the results beyond this study was restricted due to the compromised randomization and undercoverage of the population caused by the convenience sample (Agresti & Finlay, 1997).

The data set included records for 1129 8th grade students enrolled across the four county middle schools that offered Agricultural Foundations for science credit during 2013-2014 school year; county middle schools not offering agricultural courses for science credit were excluded. Variables provided by the data set included, FCAT achievement levels for previous and most recent FCAT and FCAT2 tests in reading, math, science, and writing; course enrolled for as science credit; science course teacher; reading, writing, math, and science proficiency scores; attendance data; and semester and final grades for the course. Demographic variables included gender, age, ethnicity, status of free and reduced lunch, homelessness, migrant, exceptionalities, 504 Section, ESE testing accommodations, and student first language other than English.

FCAT and FCAT2 reading achievement scores were the dependent variables. Thorough alignment of test questions to content standards validity of the FCAT tests was provided (Israel et al., 2012). Instructional validity was verified through an FDOE study which found, "any student who is seeking a regular high school diploma has been given the opportunity to learn the content measured by each required assessment" (FDOE, 2011, p. 2). To perform binary logistical regression, FCAT and FCAT2 scores were coded into pass/fail categories. Since a level 3 or higher score was considered passing (FDOE, 2015d), students scoring below level 3 were coded in the fail category and students scoring a 3-5 were assigned to the pass category.

The independent variable was course taken for 8<sup>th</sup> grade science credit. The school enrolled students into one of three courses: Agriscience Foundations, a 9th grade level introductory agricultural course; M/J Physical Science, the basic science course; or M/J Physical

Science Advanced, a more advanced science course. Each course integrated “laboratory investigations that include scientific inquiry, research, measurement, problem solving, emerging technologies, tools and equipment, as well as, experimental quality, and safety procedures” (FDOE, 2015c, p. 1; Florida State University [FSU], 2015a, p. 1; FSU 2015b, p. 1). The basic and advanced level science course covered the same content; however, the advanced course employed higher level objectives to require higher-order thinking (P. Nobels, personal communication, April 15, 2016). The Agriscience Foundations course addressed standards of reading and writing in technical subjects through the context of agriculture in addition to the CTE benchmarks.

Based upon the literature and the dataset, the following control variables were selected: gender, race-ethnicity, total days absent, free and reduced lunch status, student grade, and school (Israel & Beaulieu, 2004; Israel et al., 2012). To indicate the different levels of course content and to make a clearer comparison to the 9th grade level Agriscience Foundations course, basic and advanced course level labels were assigned. Final grade in science credit course reflected student performance. Because only a small percentage of the population were Asian students, they were condensed with White students as literature found these races tend to outperform other races on standardized tests (Israel & Beaulieu, 2004; Lareau, 2002; Steele & Aronson, 1998). Individual categories were formed for Blacks and Hispanics due to each group representing a large portion of the sample. Multi-racial and American Indian/Alaskan Native were merged into the “Other” category as a result of small numbers for each. Free and reduced lunch status was used to operationalize socioeconomic status. Student attendance was measured by total days absent. Total days out of school suspension and total days in school suspension were used to assess disruptive behavior. Student age controlled for students who had been held back or promoted a grade. Categorical independent variables were dummy coded for analysis. Reference categories were selected by categories with the largest percentage of the population and included: basic science, final letter grade B, White/Asians, males, and not eligible for free and reduced lunch.

Objectives one and two were addressed with descriptive statistics. Multiple imputation was used to address missing FCAT score levels which were missing at random as recommended by Shafer and Graham (2002). For objective one, characteristics of the samples of Agriscience Foundations students, Basic Physical Science Students, and Advanced Physical Science students were analyzed through frequencies. Frequencies were also analyzed to determine the distribution of FCAT scores for agriscience, basic science, and advanced science students to address objective two. Furthermore, analysis of crosstabs for the control variables of school, race/ethnicity, and course taken for science credit were performed.

To investigate objectives three and four, binary logistical regression was used to predict a categorical dependent variable in this case, membership in the pass or fail groups of the FCAT and FCAT2 exams, from categorical independent variables (Field, 2013; Lomax & Hahs-Vaughn, 2015; Keith 2015). The assumptions of independence of errors, non-zero cell counts, lack of influential data points, and noncollinearity were checked as recommended by Lomax and Hahs-Vaughn (2015). Although, some standardized residuals fell outside of the -3 to 3 range, the residuals were found to have a normal distribution and independence of errors were not considered to be an issue. All assumptions were met. Researchers used the hierarchical method to construct models which isolated the effect of the science course taken. Block one included predictors from the literature known to affect student achievement scores, block two included the

variable of interest (i.e. course taken for science credit and final grade in science credit course), block three included additional student control variables (Field, 2013; Lomax & Hahs-Vaughm, 2015; Keith 2015). Insignificant predicting factors were removed to find a model with the best goodness of fit and predictability statistics. Forced entry was used to confirm models once appropriate models were formed. As recommended by Field (2013) the Nagelkerke  $R^2$  statistic was chosen to represent the amount of variance explained by the model as the Cox Snell  $R^2$  never reaches its theoretical maximum of 1. For easier interpretation, odds ratios were reported instead of the Beta coefficient (Agresti & Finlay, 1997; Field, 2013). The American Psychological Association (2010) recommends the use of standardized reports of effect size in addition to original units. Standardized Beta scores were calculated using an Excel<sup>®</sup> Spreadsheet following the procedure outlined by King (2007) in Appendix A. “Variables having larger standardized beta weights (in absolute value) are considered to be stronger predictors in the equation” (King, 2007, p. 3).

## **Results**

Objective one intended to describe the characteristics of the populations of Agriscience Foundations students, Basic Physical Science students, and Advanced Physical Science students. The distribution of course selection and student attributes appear in Table 2. The course with the highest percentage of students who qualified for free lunch was Basic Physical Science (68.4%). School A and C did not offer Advanced Physical Science. The Agriscience Foundations population had a larger percentage of females (56.9%) and White, Non-Hispanic students (70.2%), and students not eligible for free or reduced lunches and a lower percentage of Black, Non-Hispanic students (8%).

Table 2.  
Distribution of course selection and student attributes.

Variable	Agriscience Foundations ( <i>n</i> = 1128)	Basic Physical Sci. ( <i>n</i> = 5112)	Advanced Physical Sci. ( <i>n</i> = 528)
Male (%)	43.1	54.8	58.0
Age (%)			
13	13.3	14.3	23.9
14	78.2	61.7	67.0
15	8.0	21.6	9.1
16	0.5	2.3	0.0
Race-ethnicity (%)			
White, Non-Hispanic	70.2	49.9	48.9
Black, Non-Hispanic	8.0	20.7	18.2
Hispanic	17.6	20.5	23.9
Asian, Pacific Islander	1.1	2.2	0.0
Multiracial, Non-Hispanic	2.7	6.3	8.0
American Indian/ Alaskan Native	0.5	0.4	1.1
Receives Testing Accommodations (%)	10.1	17.6	12.5
Total Days Absent $\mu$ ( <i>SD</i> )	9.1(10.6)	12.4(11.2)	8.3(7.2)
Free and Reduced Lunch Status (%)			
Free Lunch	53.2	68.4	59.1
Reduced Lunch	13.3	8.8	14.8
Not Eligible	33.5	22.8	26.1
School (%)			
School A	37.2	17.0	0.0
School B	11.7	17.7	35.2
School C	22.9	31.0	0.0
School D	28.8	34.3	64.8

Objective 2 aimed to determine if student enrolled in the Agriscience Foundations course as a science credit earned higher FCAT reading scores than those students enrolled in a basic or advanced science course. Table 3 shows the frequency distributions of FCAT Reading score levels for 8<sup>th</sup> grade students in agriscience, basic science, and advanced science courses. There was a statistically significant association between the Reading FCAT score level and course taken for science credit ( $X^2 = 1350.80$ ,  $df = 8$ ,  $p = <0.01$ ). On the FCAT Reading test, 95% ( $n = 1063$ ) of students in the agricultural course and 95.6% ( $n = 496$ ) of students in advance science scored a passing score of 3 or higher whereas only 61% ( $n = 3031$ ) of students enrolled in basic science score achieved a 3 or higher. There was also a statistically significant association between the Reading FCAT2 score level and the course taken for science credit ( $X^2 = 1578.72$ ,  $df = 8$ ,  $p = <0.01$ ). On the FCAT 2 Reading test, 87.5% ( $n = 987$ ) of students in the agricultural course and 88.7% ( $n = 468$ ) scored a passing score of 3 or higher whereas only 40.4% ( $n = 2058$ ) of students enrolled in a science score achieved a 3 or higher.

Table 3.

Distribution of FCAT Reading Scores for 8<sup>th</sup> Grade Agriscience, Basic Science, and Advanced Science Students.

FCAT Test	Score Level	Agriscience	Basic Science	Advanced Science
FCAT Reading <sub>A</sub>	1	1.3%	19.8%	1.5%
	2	3.8%	19.2%	2.9%
	3	30.1%	40.3%	27.4%
	4	47.7%	16.8%	46.4%
	5	17.2%	3.9%	21.8%
	Total	100.0% (1119)	100.0% (4969)	100.0% (519)
FCAT2 Reading <sub>B</sub>	1	2.1%	23.4%	1.1%
	2	10.6%	36.2%	10.2%
	3	33.5%	27.0%	30.7%
	4	34.9%	9.9%	33.0%
	5	19.1%	3.5%	25.0%
	Total	100.0% (1128)	100.0% (5094)	100.0% (528)

Note. (n)

<sub>A</sub>  $X^2 = 1350.80$ ,  $df = 8$ ,  $p = <0.01$   $N = 6607$

<sub>B</sub>  $X^2 = 1578.72$ ,  $df = 8$ ,  $p = <0.01$   $N = 6750$

The Pearson Chi-Square tests indicated significant associations between the course taken and FCAT score levels. Crosstabs were analyzed to determine significant associations between courses taken, FCAT scores, and the control variables of school and ethnicity. Agriscience students consistently performed better than basic science students in reading across all schools and race/ethnicity groups. Significant associations were found between school and reading FCAT and FCAT2 score levels for agriscience, basic science, and advanced science students based on school and ethnicity (data not shown).

Objective 3 proposed to determine what factors predicted student achievement on FCAT readings tests. Objective 4 purported to analyze how the level of the course taken related FCAT reading achievement levels. The binary logistic regression models were analyzed to investigate these objectives.

The omnibus test for the model related to whether students would pass or fail the reading FCAT indicated a statistically significant model ( $X^2_{(13)} = 1279.00$ ,  $p < 0.01$ ). The Hosmer Lemeshow Test for model fit showed suitable model fit ( $X^2_{(8)} = 7.53$ ,  $p = 0.48$ ). The Nagelkerke  $R^2$  square was 0.249 indicating that the logistic combination of all the independent variables in the final model predicted 24.9% of the variance in the Reading FCAT passage rate. The model predicted 71.7% correctly, a 2.2% increase over the intercept only model.

Table 4 displays the results of the FCAT reading model. The odds ratios reported represent the probability of success over the probability of failure on the FCAT reading test when all other factors in the model are controlled. Statistically significant predictors in the model included: agriscience Foundations ( $Exp(B) = 6.43$ ,  $p < .01$ ), advanced science ( $Exp(B) = 10.05$ ,  $p < .01$ ), final grade A ( $Exp(B) = 2.18$ ,  $p < .01$ ), final grade C ( $Exp(B) = 0.52$ ,  $p < .01$ ), final grade D ( $Exp(B) = 0.54$ ,  $p < .01$ ), final grade F ( $Exp(B) = 0.29$ ,  $p < .01$ ), race/ethnicity Black

( $Exp(B) = 0.77, p < .01$ ), race/ethnicity other ( $Exp(B) = 1.43, p = .01$ ), female ( $Exp(B) = 1.17, p = .01$ ), and free lunch status ( $Exp(B) = 0.71, p < .01$ ). There were statistically significant higher odds for students in Agriscience Foundations and advanced science to pass the reading FCAT test than students in basic science. When controlling for other variables in the model, students in Agriscience Foundations had 6.43 greater odds of passing and students in advanced science had 10.05 better odds of passing the FCAT reading test than students in basic science.

Table 4.

Predictive Ability of the Variables in the Reading FCAT Model

Variable in the Model	<i>b</i>	Standardized <i>B</i>	Wald	<i>df</i>	<i>p</i>	Odds Ratio
Course taken for Science Credit <sub>A</sub>						
Agriscience Foundations	1.86	0.15	164.31	1	<0.01	6.43
Advanced Science	2.31	0.13	111.29	1	<0.01	10.05
Final Letter Grade in Science Course <sub>B</sub>						
A	0.78	0.07	73.46	1	<0.01	2.18
C	-0.65	-0.06	83.84	1	<0.01	0.52
D	-0.62	-0.00	29.25	1	<0.01	0.54
F	-1.23	-0.04	37.33	1	<0.01	0.29
Race/Ethnicity <sub>C</sub>						
Black	-0.27	-0.02	11.80	1	<0.01	0.77
Hispanic	-0.01	-0.00	0.02	1	0.89	.99
Other	0.36	0.02	7.92	1	0.01	1.43
Sex <sub>D</sub>						
Female	0.16	0.02	6.95	1	0.01	1.17
Free and Reduced Lunch Status <sub>E</sub>						
Reduced	0.02	0.00	0.02	1	0.88	1.02
Free	-0.34	-0.03	20.88	1	<0.01	0.71
Total Days Absent	0.00	0.00	0.01	1	0.96	1.00
Constant	.803		91.00	1	<0.01	2.232

<sub>A</sub> Reference category is Basic Science

<sub>B</sub> Reference category is B

<sub>C</sub> Reference category is White/Asian

<sub>D</sub> Reference category is Male

<sub>E</sub> Reference category is Not Eligible

Students with a letter grade of A in their science course had 2.18 statistically significant better odds of passing the test than students with a B when controlling for other variables. Conversely, students with a final letter grade of C, D, and F had statistically significant lower odds of passing by a factor of 0.52, 0.54, and 0.29, respectively, when controlling for other student variables. Compared to White/Asian students, the odds of Black students passing the FCAT reading test were statistically significantly lower by a factor of 0.77, and the odds of Other students passing the test were higher by a factor of 1.43, when all other variables were controlled. Females had a statistically significant odds ratio of 1.17 times higher than male students when controlling for other variables. Students enrolled in the free lunch program had statistically significant lower odds of passing the test by a factor of 0.71.

Correlations were checked to identify the possibility of suppressor variables; while there were significant correlations, all coefficients were below  $r = .51$  and did not indicate a strong effect size (Ferguson, 2009). Based upon the standardized Beta scores, being enrolled in the agriscience had the largest effect on increasing the odds of group membership in the FCAT reading pass group.

The omnibus test for the model created to analyze how the level of the course taken related FCAT2 reading achievement levels demonstrated a statistical significance ( $X^2_{(14)} = 2407.32, p < 0.01$ ). The Hosmer and Lemeshow Test for model fit showed suitable model fit ( $X^2_{(8)} = 14.20, p = 0.08$ ). The Nagelkerke  $R^2$  ranged from 0.40, indicating that the logistic combination of all the independent variables in the final model predicted 40% of the variance in the reading FCAT2 passage rate. The model predicted 74% correctly, a 22% increase over the intercept only model.

Table 5 displays the results of the model. The odds ratios reported represent the probability of success over the probability of failure on the reading FCAT2 test when all other factors in the model are controlled. Statistically significant predictors in the model included: Agriscience Foundations ( $Exp(B) = 4.38, p < .01$ ), advanced science ( $Exp(B) = 8.22, p < .01$ ), final grade A ( $Exp(B) = 3.63, p < .01$ ), final grade C ( $Exp(B) = 0.39, p < .01$ ), final grade D ( $Exp(B) = 0.46, p < .01$ ), final grade F ( $Exp(B) = 0.27, p < .01$ ), race/ethnicity Black ( $Exp(B) = 0.61, p < .01$ ), female ( $Exp(B) = 1.27, p < .01$ ), reduced lunch status ( $Exp(B) = 0.66, p < .01$ ), free lunch status ( $Exp(B) = 0.67, p < .01$ ), total days absent ( $Exp(B) = 1.01, p < .01$ ), and student age ( $Exp(B) = 0.50, p < .01$ ). Student enrolled in the agriscience had statistically significant greater odds of membership in the pass group of the reading FCAT2 than students enrolled in basic science by 4.38 times, when student variables were controlled. Likewise, students enrolled in advanced science had a statistically significant odds ratio of 8.22, indicative of a greater chance of being in the pass group when controlling for other variables in the model.

Table 5.  
 Predictive Ability of the Variables in the Reading FCAT2 Model

Variable in the Model	<i>b</i>	<i>Standardized B</i>	<i>Wald</i>	<i>df</i>	<i>p</i>	<i>Odds Ratio</i>
Course taken for Science Credit <sup>A</sup>						
Agriscience Foundations	1.48	0.16	211.32	1	<0.01	4.38
Advanced Science	2.11	0.14	13.04	1	<0.01	8.22
Final Letter Grade in Science Course <sup>B</sup>						
A	1.289	0.14	260.41	1	<0.01	3.63
C	-0.93	-0.10	145.49	1	<0.01	0.39
D	-0.78	-0.05	35.17	1	<0.01	0.46
F	-1.31	-0.05	27.10	1	<0.01	0.27
Ethnicity <sup>C</sup>						
Black	-0.50	-0.05	36.49	1	<0.01	0.61
Hispanic	-0.14	-0.01	3.03	1	0.08	0.87
Other	0.13	0.01	1.24	1	0.27	1.14
Sex <sup>D</sup>						
Female	0.24	0.03	15.90	1	<0.01	1.27
Free and Reduced Lunch Status <sup>E</sup>						
Reduced	-0.42	-0.03	13.86	1	<0.01	.66
Free	-0.39	-0.05	29.54	1	<0.01	.67
Total Days Absent	0.01	0.03	14.58	1	<0.01	1.01
Student Age	-0.69	-0.11	194.32	1	<0.01	0.50
Constant	9.61		188.84	1	<0.01	14871.71

<sup>A</sup> Reference category is Basic Science

<sup>B</sup> Reference category is B

<sup>C</sup> Reference category is White/Asian

<sup>D</sup> Reference category is Male

<sup>E</sup> Reference category is Not Eligible

Final letter grade in the course taken for science credit had statistically significant odds across all categories when controlling for the other variables. The odds of passing is higher for a student scoring a final letter grade of an A rather than a B by a factor of 3.63. Students scoring lower than a B had lower odds of passing the reading FCAT2 by a factor of 0.39 for those earning a C, by a factor of 0.46 for those earning a D, and by a factor of 0.27 for those earning an F. When controlled for other variables, the odds of Black students passing compared to White/Asian students were statistically significantly lower by a factor of 0.61. Females had statistically significant odds of 1.27 for passing the Reading FCAT2 test than males when controlling for other variables. Controlled for other variables, student who were enrolled in the free and reduced lunch program had statistically significant lower odds of passing than students who were not enrolled by a factor of 0.67 and 0.66, respectively. Although statistically significant, the odds of passing in response to an increase in total days absent were negligible with an odds ratio of 1.01 when other variables were controlled. For each additional year in age, the statistically significant odds of passing the reading FCAT2 decreased by a factor of 0.50, controlling for other variables.



Correlations were checked to identify the possibility of suppressor variables; while there were significant correlations, all coefficients were below  $r = .51$  and did not indicate a strong effect size (Ferguson, 2009). Based upon the standardized Beta scores, being enrolled in the Agriscience Foundations had the largest effect on increasing the odds of group membership in the reading FCAT2 pass group.

### Conclusions

Objective 1 aimed to describe the characteristics of the population of students enrolled in Agriscience Foundations, Basic Physical Science, and Advanced Physical Science. Demographic and independent variables differed for the student populations of the three courses taken for science credit. Age, race, total days absent, free and reduced lunch, and schools were important differences among these courses. The higher percentages of students who were 15-16 years old may suggest that students who had been retained were enrolled in basic science, since most students enter high school at 14 years old. The Agriscience Foundations course lacked diversity compared to the other courses, supporting the claims of other researchers who have called for agriscience programs recruit a diverse population that mimics that of the school itself (Torres, Kitchel, & Ball, 2010). The basic science course also had the highest mean score of total days absent, which could contribute to the lower achievement scores of these students (Lamdin, 1996). The basic science course had the largest percentage of students qualifying for free lunches signifying a lower social economic status. These findings elucidate how demographic variables may determine hierarchies in course enrollment, lending support to the status attainment theory (Duncan et al., 1972). An advanced science course was not offered at School A or School C. Since the odds for passing the reading FCAT tests were higher for Agriscience Foundations students than basic science students, students should be encouraged to take Agriscience Foundations when advanced science courses are not offered in the school.

Objective two was designed to determine if students enrolled in the Agriscience Foundations course as a science credit scored higher on FCAT reading tests than students enrolled in a science course. All of the crosstabs had significant chi-squared statistics indicating a statistically significant association between the FCAT score level and course taken for science credit. A pattern of a higher distribution of students in basic science scoring lower FCAT score levels and a small distribution of them scoring in the higher FCAT score levels emerged. On the other hand, agriscience and advanced science students had a lower distribution of students scoring at lower FCAT levels and a higher distribution of students scoring in the higher levels. Students in advanced science performed slightly higher than the agriscience students. Overall, the results from objective two indicate that agriscience students scored higher than basic science students and equivalent to slightly lower than advanced science students on all FCAT tests.

Objective three proposed to ascertain what factors predict student achievement in FCAT reading tests. Although nine variables in the reading FCAT model and 12 variables in the reading FCAT2 model were significant at the  $p = 0.05$  level set *a priori*, only those variables associated with course and letter grade had an effect size which met the recommended minimum of 2.0 for a practically significant effect for social science data as purported by Ferguson (2009). Based upon the standardized Beta scores, being enrolled in the agriscience course had the largest effect on increasing the odds of group membership in the FCAT reading pass group. The final letter grade in the course taken for science credit proved to be significant in predicting the odds of passing the reading FCAT test. This finding suggests that student achievement in their science course is positively related to reading achievement. Continued effort should be aimed at integrating

disciplinary literacy skills into these science courses (Park et al., 2010). Compared to the models presented in Warner et al., (2017a, 2017b), the two reading models had the lowest odds ratio associated with course taken for science credit. This may indicate an opportunity for all of these courses to integrate better instruction and use of disciplinary literacy strategies to further strengthen student achievement in reading (Park et al., 2010).

Black students had the worst odds of passing the reading test. Hispanic students performed at very similar rates as the White/Asian students. Students in the Other race category had greater odds of passing the reading FCAT, although the extremely small sample size may have inflated the effect size of this population's results. Although females had statistically significant higher odds of passing the reading FCAT, the effect size was negligible. Students of a lower socio-economic status as represented by enrollment in the free lunch program also had lower odds of passing the test. Based on these results, test creators should evaluate the tests to ensure no biases exclude diverse students from passing. Moreover, teachers and school administration should continue to invest efforts into providing a high-quality education to all members of the diverse student population. Future research should look at whether minorities do better in Agriscience Foundations than in basic science, thus reducing the achievement gap.

To address objective four, researchers analyzed how the level of the course taken for science credit was related to FCAT reading achievement scores. Both models indicated that students enrolled in Agriscience Foundations had higher odds of passing the FCAT reading tests than students in basic science when all other variables were controlled. Since hierarchical regression was utilized, this increase in odds accounted for additional variability above that which could be contributed to known achievement predictor control variables within the model (Keith, 2015). This finding supports the findings of other researchers that students in CTE, specifically agricultural education programs, have higher achievement scores (Chiasson & Burnett, 2001; Conroy, et al., 1999; Israel, et al., 2012; Shinn et al., 2003; Stripling & Roberts, 2012). The findings suggest that the Agriscience Foundations course supports the development of students' reading abilities they need to be successful in 8<sup>th</sup> grade. Schools should consider the relationship between Agriscience Foundations enrollment and student achievement. Additionally, they should offer more middle school students the opportunity to take Agriscience Foundations in place of basic science in 8<sup>th</sup> grade, especially when advanced science is not offered. Additional research is needed to determine what contributes to the increased student achievement in these courses. Is it associated with learning the content in the context of agriculture (FDOE, 2015c), the use of different teaching methods, the students' motivation and engagement level (Young, 2013), a hands-on approach to teaching or some other factors? Additional research may address contextualized reading and impacts on math and science achievement.

The regression models indicated that advanced science students had greater odds of passing the FCAT reading tests than both the basic science and agriscience students. Agriscience teachers should collaborate with advanced science teachers to determine strategies that could be added to the Agriscience Foundations course, which may further increase the academic success of students. The major difference between the basic and advanced level science courses was the higher-order learning objectives utilized (Patricia Nobles, personal communication, April 15, 2016). Researchers should analyze advanced science and agriscience learning objectives to determine if differences exist within the level of thinking required by the objectives. Further research should examine if students will perform higher academically in an agriscience class that

maintains a focus in higher-order thinking. Further, an examination between the relationship of the applied nature of agriculture course and higher-order reasoning skills may be warranted.

This study was limited by the potential for specification error due to the measurement error of variables used and/or omitted variables. Additionally, random sampling of middle schools throughout Florida would allow generalizations to be drawn. This study was unable to control for threats of maturation and history to external validity, which provides additional limitations to generalizability (Ary, Jacobs, Sorenson, & Walker, 2010). Future research can focus on including additional predictor variables outlined by Israel and Beaulieu (2004) to provide further insight; hierarchical linear modeling to analyze of nested data such as school and teacher characteristics without violating the assumptions of independence (Field, 2013); and replicating the study with the new Florida Assessments Standard, high school assessments, and state assessment tests in other states.

### References

- Agresti, A. & Finlay, B. (1997). *Statistical Methods for the Social Sciences*. Upper Saddle River, NJ: Prentice Hall.
- American Psychological Association (APA). (2010). *Publication manual of the American Psychological Association*. Washington D.C.: American Psychological Association.
- Ary, D., Jacobs, L. C., Sorensen, C. K., & Walker, D. A. (2010). *Introduction to Research in Education* (9<sup>th</sup> ed.). Belmont, CA: Wadsworth Cengage Learning.
- Bunch, J. C., Robinson, S., Edwards, M. C., & Antonenko, P. D. (2014). How a serious digital game affected students' animal science and mathematical competence in agricultural education. *Journal of Agricultural Education*, 55(3), 57-71. doi: 10.5032/jae.2014.03057.
- Buriak, P., McNurlen, B., & Harper, J. G. (1996). Toward a scientific basis for the craft of teaching. *Journal of Agricultural Education*, 37(4), 23-35. doi: 10.5032/jae.1996.04023
- Cappella, E., & Weinstein, R. S. (2001). Turning around reading achievement: Predictors of high school students' academic resilience. *Journal of Educational Psychology*, 93(4), 758-771. doi: 10.1037//0022-0663.93.4.758
- Chapman, S. C. (2015). *Disciplinary literacy: A study of the cognitive, social, and semiotic practices of disciplinary experts*. (Doctoral dissertation). Retrieved from University of Florida Digital Collections. (LD178- 2015)
- Chiasson, T. C., Burnett, M. F. (2001). The influence of enrollment in agriscience courses on the science achievement of high school students. *Journal of Agricultural Education*, 42(1), 61-71. doi: 10.5032/jae.2001.01061
- Conroy, C. A., Trumbull, D. J., & Johnson, D. (1999). *Agriculture as a rich context for teaching and learning, and for learning mathematics and science to prepare for the workforce of the 21<sup>st</sup> century*. Paper presented at the Transitions from Childhood to the Workforce Teaching and Learning Conference, Ithaca, NY.

- Conroy, C., & Walker, N. (1998). *National Aquaculture Curriculum Evaluation Phase II Final Report*. Ithaca, NY: Cornell University
- Doolittle, P. E., & Camp, W. G. (1999). Constructivism: The career and technical education perspective. *Journal of Career and Technical Education*, 16(1), 23-46.
- Duncan, O. D., Featherman, D. L., & Duncan, B. (1972). *Socioeconomic background and achievement*. New York, NY: Seminar Press.
- Dworkin, M. S. (1959). *Dewey on education*. NY: Teachers College Press.
- Field, A. (2013). *Discovering Statistics Using IBM SPSS Statistics*. Thousand Oaks, CA: Sage Publications.
- Florida Department of Education (FDOE). (2009). *Understanding FCAT Reports: 2009*. Retrieved from <http://www.fldoe.org/>
- Florida, Department of Education (FDOE). (2011). *2011 Instructional Validity Study*. Retrieved from [http://www.fasa.net/upload\\_documents/2011-08-19-FFF\\_2011InstructionalValidityFCAT20EOCAIignmentStudyFI.pdf](http://www.fasa.net/upload_documents/2011-08-19-FFF_2011InstructionalValidityFCAT20EOCAIignmentStudyFI.pdf)
- Florida, Department of Education (FDOE). (2014). *Language Arts Florida Standards Grades 11 & 12*. Retrieved from [http://www.fldoe.org/core/fileparse.php/12087/urlt/G11-12\\_LanguageArts\\_Florida\\_Standards.pdf](http://www.fldoe.org/core/fileparse.php/12087/urlt/G11-12_LanguageArts_Florida_Standards.pdf)
- Florida Department of Education (FDOE). (2015a). *FCAT*. Retrieved from <http://www.fldoe.org/accountability/assessments/k-12-student-assessment/history-of-fls-statewide-assessment/fcat/>
- Florida Department of Education (FDOE). (2015b). *FCAT 2.0 and Florida EOC assessments achievement levels*. Retrieved from <http://www.fldoe.org/>
- Florida Department of Education (FDOE). (2015c). *Student Performance Standards: Agriscience Foundations 1*. Retrieved from <http://www.fldoe.org/academics/career-adult-edu/career-tech-edu/curriculum-frameworks/2016-17-frameworks/agriculture-food-natural-resources.stml>
- Florida Department of Education (FDOE). (2015d). *Understanding FCAT 2.0 Reports: Spring 2014*. Retrieved from <http://www.fldoe.org/>
- Florida State University. (2015a). *CPALMS: M/J Physical Science (#2003010)*. Retrieved from <http://www.cpalms.org/Public/PreviewCourse/Preview/13126>
- Florida State University. (2015b). *CPALMS: M/J Physical Science, Advanced (#2003020)*. Retrieved from <http://www.cpalms.org/Public/PreviewCourse/Preview/13127>

- Forget, M., & Bottoms, G. (2000). *Academic and vocational teachers can improve the reading and achievement of male career-bound students*. Atlanta, GA: Southern Regional Education Board.
- Fosnot, C. T. (1996). Constructivism: A psychological theory of learning. In C. T. Fosnot (Ed.), *Constructivism: Theory, perspectives, and practice*. P. 8-33. New York: Teachers College Press.
- Israel, G. D., & Beaulieu, L. J. (2004). Laying the foundation for employment: The Role of social capital in educational achievement. *The Review of Regional Studies*, 34(3), 260-287.
- Israel, G. D., Myers, B. E., Lamm, A. J., & Galindo-Gonzalez, S. (2012). CTE students and science achievement: Does type of coursework and occupational cluster matter? *Career and Technical Education Research*, 37(1), p. 3-20. doi: 10.5328/cter37.1.3
- K-20 Education Code, 48 Flo. Stat. § 1003-43 (2011).
- Keith, T. Z. (2006). *Multiple regression and beyond* (1<sup>st</sup> ed.). Boston, MA: Pearson.
- King, J. E. (2007, February). *Standardized coefficients in logistical regression*. Paper presented at the meeting of the Southwest Educational Research Association, San Antonio, Texas.
- Lamdin, D. J. (1996). Evidence of student attendance as an independent variable in education production functions. *The Journal of Educational Research*, 89(3), 155-162. doi:10.1080/00220671.1996.9941321
- Lareau, A. (2002) Invisible inequality: Social class and childrearing in black families and white families. *American Sociological Review*, 67, 747-776.
- Lester, J. H. (2000). Secondary instruction: Does literacy fit in?. *High School Journal*, 83(3), 10.
- Lomax, R. G. & Hahs-Vaughn, D. L. (2015). *Statistical Concepts: A Second Course (4<sup>th</sup> edition)*. Philadelphia, PA: Taylor & Fransis.
- Meeder, H., & Suddreth, T. (2012). *Common core state standards and Career and Technical Education: Bridging the divide between college and career readiness*. Retrieved from Achieve, Inc. website: <http://www.achieve.org/CCSS-CTE-BridgingtheDivide>
- Moje, E.B. (2008) Foregrounding the disciplines in secondary literacy teaching and learning: A call for change. *Journal of Adolescent and Adult Literacy*, 52(2), 96-107.
- Nolin, J. B. & Parr, B. (2013). Utilization of a high stakes high school graduation exam to access the impact of agricultural education: A measure of curriculum integration. *Journal of Agricultural Education*, 54(3), 41-53. doi: 10.5032/jae.2013.03041
- Park, T. D., & Osborne, E. (2007). A model for the study of reading in agriscience. *Journal of Agricultural Education*, 48(1), 20-30. doi: 10.5032/jae.2007/01020

- Park, T. D., & Osborne, E. (2005). Process and product variables for the study of reading in secondary agriscience. *Journal of Agricultural Education*, 46(3), 12-22. doi: 10.5032/jae.2005/03012
- Park, T. D., Pearson, D., & Richardson, G. B. (2017). Curriculum integration: Helping career and technical education students truly develop college and career readiness. *Peabody Journal of Education*, 92(2), 192-208. doi: 10.1080/0161956X.2017.1302213
- Park, T. D., van der Mandele, E. S., & Welch, D. (2010). Creating a culture that fosters disciplinary literacy in agricultural sciences. *Journal of Agricultural Education*, 51(3), 100-113. doi: 10.5032/jae.2010/03100
- Parr, B. A., Edwards, M. C., & Leising, J. G. (2006). Effects of a math-enhance curriculum and instructional approach on mathematics achievement of agricultural power and technology students: An experimental study. *Journal of Agricultural Education*, 47(3), 81-93. doi: 10.5032/jae.2006.03081
- Parr, B. A., Edwards, M. C., & Leising, J. G. (2008). Does a curriculum integration intervention to improve the mathematics achievement of students diminish their acquisition of technical competence? An experimental study in agricultural mechanics. *Journal of Agricultural Education*, 49(1), 61-71. doi: 10.5032/jae.2008.01061
- Parr, B. A., Edwards, M. C., & Leising, J. G. (2009). Selected effects of a curriculum integration intervention on the mathematics performance of secondary students enrolled in an agricultural power and technology course: An experimental study. *Journal of Agricultural Education*, 50(1), 57-69. doi: 10.5032/jae.2009.01057
- Piaget, J. (1976). *The child & reality*. (Trans A. Rosin). Oxford, England: Penguin.
- Schafer, J. L. & Graham, J. W. (2002). Missing data: Our view of the state of the art. *Psychological Methods*, 7(2), 147-177.
- Shanahan, T. & Shanahan, C. (2008). Teaching disciplinary literacy to adolescents: Rethinking content-area literacy. *Harvard Educational Review*, 78(1), 40-59.
- Shinn, G. C., Briers, G. E., Christiansen, J. E., Edwards, M. C., Harlin, J. F., Lawver, D. E., Lindner, J. R., Murphy, T. H., and Parr, B.A. (2003). *Improving student achievement in mathematics: An important role for secondary agricultural education in the 21st Century*. Unpublished manuscript. Texas A&M University. College Station, TX
- Snow, C. (2002). *Reading for Understanding: Toward an R&D Program in Reading Comprehension*. Santa Monica, CA: The RAND Corporation.
- Steele, C., & Aronson, J. (1998). Stereotype threat and the test performance of successful African Americans. In Jencks, C., & Philips, M. (Eds.), *The Black-white test score gap* (pp. 401-427). Washington, DC: The Brookings Institution Press.

- Stripling, C. T., & Roberts, T. G. (2012). Florida preservice agricultural education teachers' mathematics ability and efficacy. *Journal of Agricultural Education, 53*(1), 109-122. doi: 10.5032/jae.2012.01109
- Torres, R. M., Kitchel, T., & Ball, A. L. (Ed.) (2010). *Preparing and advancing teachers in agricultural education*. Columbus, OH: Curriculum Material Service, The Ohio State University.
- United States Department of Education, Institute of Education Sciences, National Center for Education Statistics. (2016). The Condition of Education 2016 (NCES Publication No. 2016-144). Retrieved from <https://nces.ed.gov/pubs2016/2016144.pdf>
- Vacca, R. T., & Vacca J. L. (2005). *Content area reading: Literacy and learning across the curriculum* (8<sup>th</sup> ed.). Boston, MA: Pearson.
- Vygotsky, L. S. (1962). *Thought and language*. Cambridge MA: MIT Press.
- Warner, A. J., Thoron, A. C., & Israel, G. D. (2017a, February). *Comparative Analysis of Students Taught Science or Agriscience: Results on State Standardized Science Assessment*. Southern Region meeting of the American Association for Agricultural Education, Mobile, AL.
- Warner, A. J., Thoron, A. C., & Israel, G. D. (2017b, May). *Comparative Analysis of Students Taught Science or Agriscience: Results on State Standardized Math Assessment*. Annual meeting of the American Association for Agricultural Education, San Luis Obispo, CA.
- Wilson, K. L., & Portes, A. (1975). The educational attainment process: Results from a national sample. *American Journal of Sociology, 81*(2), 343-363.
- Young, A. (2013). *Engagement and motivation in learning: Perspectives of middle school agricultural education students* (Master's thesis). Retrieved from University of Florida Digital Collections.

## Effects of Novelty on Project-Based Methods when Integrating Physics into Agriculture Courses

Jason D. McKibben, West Virginia University  
Timothy H. Murphy, Texas A&M University

### Abstract

Researchers have reported that participation in agricultural education reinforces STEM concepts. The use of projects in instruction is common in agricultural education. However, the foundational understanding of certain tenets of this method of instruction is not clear. A quasi-experimental study was conducted to test how real and/or authentic projects need to be to affect learning. Agriculture Food and Natural Resources students in Texas were sampled and assigned as a cohort group to one of four treatment groups ( $N = 219$ ). Fourteen cohort groups (class periods) were identified in five sites. Each of the 14 cohort groups were randomly assigned to one of the four project types varying in their design according to the degree of project novelty when learning about electricity.

An analysis of covariance (ANCOVA) was used to test the effects of perceived novelty on change scores in a pretest posttest quasi-experimental design. A test of project type groups, which varied on novelty, yielded statistically significant results ( $p < .05$ ) with small effect size ( $\omega^2 = .04$ ). Additionally, a Pearson Chi Square analysis was run to determine if a relationship between novelty and project type existed. The relationship between these two variables was determined to be significant,  $X^2(12, N=152) = 22.35, p = .034$ . It can be confidently said that the manipulation of the treatment affected the independent variable, as predicted.

A pairwise comparison was calculated to compare levels of novelty to determine where the variation exists within the variable reported novelty levels. Students with novelty level 4 had statistically different change scores than those at novelty level 2 ( $p = .006$ ) and students with novelty level 4 were different from those with a novelty level 5 ( $p = .012$ ).

### Introduction

A student's lack of familiarity with a given method of instruction could be damaging to the individuals' educative outcomes due to the apprehension or uneasiness they feel specifically when using the project-based learning method (Larmer & Mergendollar, 2015). However, Headwig von Restorff (1933) demonstrated that students learned quicker and more deeply if the information they were expected to know was done in a way that was different or novel from the rest of the information. Von Restorff (1933) and the subsequent iterations of her experiments used immediate known novelty to the individuals to highlight the different groups (Samuels, 1986). When done with adult students, Mezirow's theories of transformative learning conveniently explain how reflection on disruption of ideals and pre-held understandings, such as in von Restorff's experiments, is the ideal of true epistemic cognition or learning (Mezirow, 2000). Both von Restorff and Mezirow's ideas about education fly in stark contrast to the modern



interpretation of project-learning that education is most effective when in a known and easily understood context.

Agricultural education has had a long and well-documented history with the use of project-based learning (Hillison, 1998; Roberts & Harlin, 2007; Moore, 1988). Project-based learning methods are ubiquitous in secondary agriculture courses (Buriak, 1989; Moore, 1988; Parr & Edwards, 2004; Roberts & Harlin, 2007). The connection agricultural education has to project-based learning has been most extensively explored in the context of supervised agricultural experience (SAE). However, the use of projects most frequently extends well into the classroom, outside of the examined SAE contexts. Roberts and Harlin's (2007) work on the implementation of projects in agricultural education leads to the assumption that, in the years since the founding of formal school-based agricultural education, project focus has shifted from a two faceted approach of in-school and out-of-school projects to focusing exclusively on out-of-school (home based) projects. Outside of agricultural education, the use of project-based learning is primarily focused on implementation within the confines of an in-school setting.

Krajcik and Blumenfeld (2006), as well as Grenno (2006), advocate for the use of projects in the classroom as way to learn through situated perspectives in the general learning environment. Researchers have reported specific criteria or elements to effectively implement these projects in the classroom (Blumenfeld et al., 1994; Krajcik & Blumenfeld 2006; Krajcik, Czerniak & Berger, 2002; Larmer & Mergendoller, 2015; Krajcik, Blumenfeld, Marx & Soloway, 1994). Often these criteria are referred to as necessities within project implementation or what could be called, best practice. While much work has been done on qualifying the validity of the suggested elements or criteria, many of the elements suggested as best practice have not been well defined or researched before they were suggested as necessary (Personal communication Mergendoller, October 15, 2015; Personal communications Larmer, October 12, 2015). In essence, elements of these best practices are based on untested conjecture or postulation.

### **Framework**

Carroll's (1963, 1989) model of school learning and Bandura's social learning theory (SLT; 1977) were used as the theoretical framework for this study. Carroll suggested that academic achievement is the result of aptitude (Figure 1). He proposed that aptitude's effect on academic achievement is mitigated by four factors; (a) opportunity to learn, (b) ability to understand instruction, (c) quality of instruction, and (d) perseverance (Reeves & Reeves, 1997).

Quality of instruction, and the three other criterion that define the model of school learning as postulated by Carroll (1963, 1989), are understood to affect the levels of academic achievement. As such, any change in the quality of instruction, if all other things are kept constant, should consequently change academic achievement (Carroll, 1963, 1989). Students must be aware of what they are going to learn, that they are "put in adequate contact with learning materials, and that steps in learning must be carefully planned and ordered" (Carroll, 1989, p. 26). If project design affects the quality of instruction as suggested by the advocates for project-based learning, and student familiarity with the project affects the implementation of that design, it could be postulated that changing the level of familiarity or novelty should change the level of academic

achievement. However, with no evidence this change in academic achievement is only theoretical.

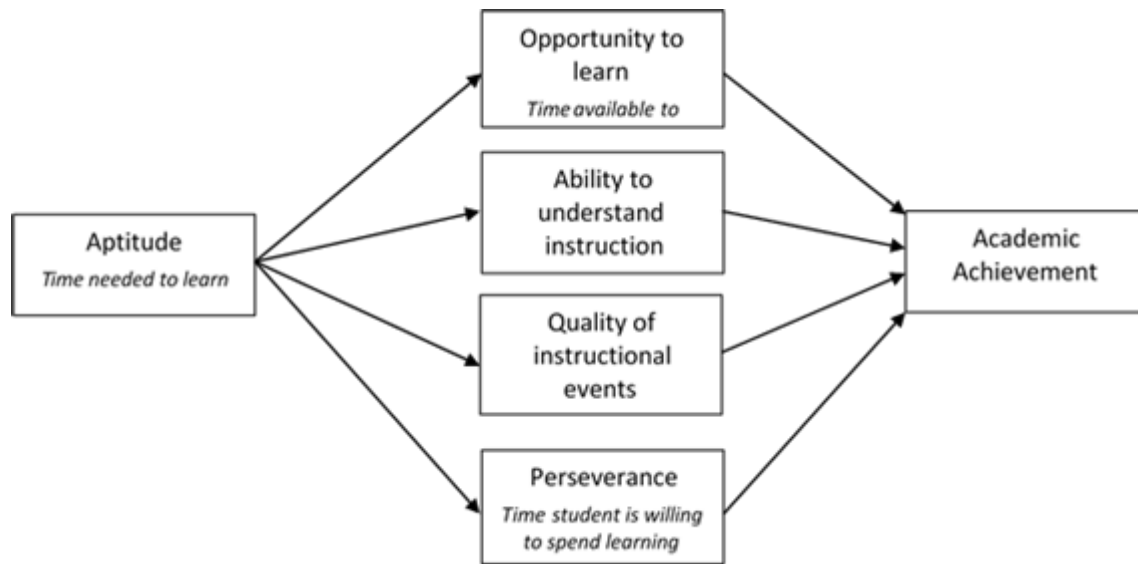

Figure 1. Carroll's model of school learning. This model shows the inputs that affect student academic achievement. Reprinted from (Carroll, 1963; 1989).

Along with Carroll, Bandura's model of social learning theory (SLT) can be used to understand the underlying design of this study. Bandura (1971; 1977) theorized that learning is a cognitive process that occurs in a social setting, occurs through both observational and direct instruction, and is shaped by observing both positive and negative stimuli. In SLT, Bandura (1971; 1977) described the learning process as a reciprocal interaction between the individual's environment and their understanding of that environment. Within the reciprocal relationship, there is a triadic relationship of behavior (*B*), environment (*E*), and cognition (*P*). Any change in *E* will theoretically result in changes to *B* and/or *P*, or any combination thereof. Further, use of SLT allows researchers to predict that any change in any direction of the environment should result in a change in cognition.

As in Carroll's model any change in the environment (i.e. instructional design) should result in a change in the behavior and/or the cognition. Using Bandura's model, I focused on the purposeful change of novelty (*E*), measuring the resulting change in cognition (*P*) while using guided behaviors (*B*) within the framework of a hands-on lesson of unique projects in a project based learning setting. Any manipulation of the project-based lesson would in turn be a manipulation of the environment within which the student is operating. The purpose of this study was to determine if the purposeful manipulation of an educational experience based on novelty (*E*) would result in changes in the cognition (*P*) of the individuals participating, as suggested by Bandura (1971; 1977). An environmental determinant (novelty) was manipulated in a manner that would elicit unknown behaviors (solutions). Success for those behaviors could only occur in a finite number of ways.

## Purpose and Hypothesis

The purpose of this quasi-experiment was to test the effect of project novelty, on academic achievement in physics.

H<sub>01</sub>: There are no differences in academic achievement change scores  $O\Delta$  among the level of novelty with the project when population means have been adjusted for covariation.

$$X_1 (O\Delta) = X_2 (O\Delta) = X_3 (O\Delta) = X_4 (O\Delta) = X_5 (O\Delta)$$

Variables: IV= Reported level of novelty with the project ( $X_{1-5}$ )  
DV= Change scores representing academic achievement posttest subtracted from pretest ( $O\Delta$ )

Covariates: CV<sub>1</sub> = prior course work (Course Chem, Course PhySci, Course Bio, Course Phy, Course IPC, Course Astro, Course None, Course Earth, Course Enviro)  
CV<sub>2</sub> = Grade in school (grade 9, grade 10, grade 11, grade 12)

## Methods

In efforts to identify the effects of project-based learning in STEM learning, a quasi-experimental study was conducted to test suggested elements of project-based learning design's effect on academic achievement. A purposive sample of agriculture food and natural resources students in Texas was made ( $N = 219$ ). Fourteen cohort groups (class periods) were identified in five sites. Each of the 14 cohort groups were assigned to one of the four project types. The project types varied in their design based on assertions made by Larmer and Mergendoller that students perform better if they are familiar with the project type (2015). Those projects were completing a commercially available paper curriculum packet with readings and questions (Paper), drawing a wiring diagram (Drawing), wiring using electro conductive play-doughs and LED probe lights (Squishy), and wiring using traditional wires and screw based bulbs (Wiring). The assigned projects were application phases of a project-based learning lesson during a direct current electricity lesson. The project phase of the lesson followed a direct instruction phase that was facilitated through a commercially available video verified by experts in the field of electricity. All participants completed the same direct instruction phase, variation in treatment occurred in the application project phase only. All treatments were normalized for time, in keeping with Carroll's model.

Erring on the side of exclusion any participant who did not complete all portions of the experience (pre-test, direct instruction, project phase, post-test) or did not complete either the pre or post assessment to its fullest extent were excluded. Analysis was conducted on ( $n = 152$ ). An analysis of covariance (ANCOVA) was used in a pretest - posttest design calculating a change score in the assessment of knowledge.

The assessment of knowledge portion of the instrument consisted of a 23 multiple choice question assessment taken from the Massachusetts Comprehensive Assessment System (MCAS). The MCAS was selected due to the high percentage (63.6%) of Massachusetts students who scored four or above out of five on the physics' electricity and magnetism advanced placement exam (College Board, 2014). The physics' electricity and magnetism components of the advanced placement exam address the content of the lessons used as treatments in this study. The Advanced Placement (AP) exam is a national exam taken by thousands of students. As such, the AP exam would be the most appropriate norm-referenced assessment to use. However, rights to this exam could not be secured. The MCAS exam was available, and determined to be an appropriate assessment. The use of a known and verified standardized test such as the MCAS was intended to ensure the content validity with regards to physics learning. Covariates were gathered along with other demographic data in the same instrument, asking students what classes they had participated in prior to that school year and what year of school they were in during the time of the activity.

The assessment instrument also contained questions designed to ascertain the student experience with the projects. Participants were asked if they had participated in a project similar to the one they did previously to this experience. These questions were asked in an attempt to identify if the projects completed were novel to the student or if it was similar to projects they had already experienced. These affective questions were evaluated by a panel of experts to ensure the construct validity of those items. To ensure that assertions of the results of the assessment were valid, the assessment was evaluated by experts in the field of agricultural education, agricultural mechanics, secondary science education, and the implementation of project based methods, which meets standard 1.7 of the *Standards for Education and Psychological Testing* (2014). This standard instructs researchers to ensure experts used to validate instruments are appropriate and qualified, and selected through systematic and reliable means (2014).

## **Findings**

Covariates for this analysis were previous coursework and grade in school. According to Field (2013), all covariates should be tested against the independent variable to ensure their independence. Field's (2013) suggested procedure to test the independence of covariates is calculating an analysis of variation, where groups is used as independent variable and covariate is the dependent variable. Using this method, all covariates were determined to be independent of the grouping.

Reported novelty by project type is displayed in Table 1 and Figure 2. Mean scores for the change in score from pretest to posttest by reported novelty group is reported in Table 2. Novelty is ranked 1, 2, 3, 4, and 5. A rank of 5 indicates that participants had "definitely not participated" in a project like the one they participated in with this study, and a rank of 1 indicates that they "definitely had participated" in a project like the one they participated in with this study.

Table 1

*Reported Novelty of the Project per Treatment Group*

Have you ever participated in a project like this before?		Wiring	Squishy	Drawing	Paper	Total
Definitely Yes (1)	<i>n</i>	10	4	6	4	24
	% of project	21.70	6.70	24.00	19.00	15.80
Probably Yes (2)	<i>n</i>	7	6	1	5	19
	% of project	15.20	10.0	4.00	23.80	12.50
Maybe (3)	<i>n</i>	9	11	5	2	27
	% of project	19.60	18.30	20.00	9.50	17.80
Probably Not (4)	<i>n</i>	14	14	3	2	33
	% of project	30.40	23.30	12.00	9.50	21.70
Definitely Not (5)	<i>n</i>	6	25	10	8	49
	% of project	13.00	41.70	40.00	38.10	32.20
Total	<i>n</i>	46	60	25	21	152
	% of project	30.30	39.50	16.40	13.80	100

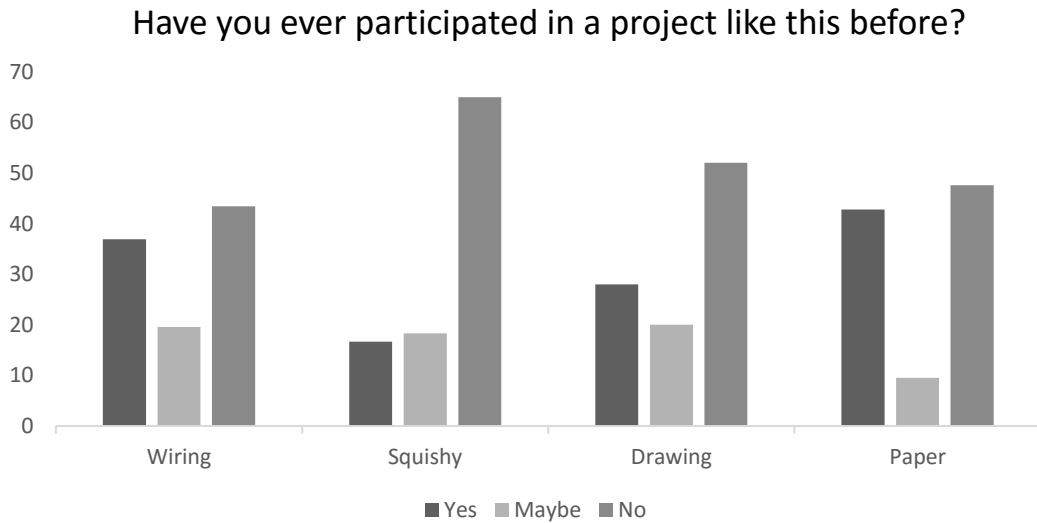

*Figure 2.* Novelty report by participants. Positive answers were aggregated and negative were aggregated for visual ease. The more negative the response the more novelty.

Table 2

*Change Scores for reported novelty groups*

---

Have you ever participated in a project like this before?	<i>M</i>	<i>SD</i>	<i>n</i>
Definitely Yes (1)	.54	14.18	24
Probably Yes (2)	-3.66	13.92	19
Maybe (3)	2.42	11.96	27
Probably Not (4)	9.10	13.5	33
Definitely Not (5)	1.69	14.39	49
Total	2.57	14.08	152

---

Analyzing the results of the ANCOVA, statistically significant results were noted based on student's reported novelty ( $F(4,138) = 2.56, p = .041, \omega^2 = .04$ ). Considering these results,  $H_{O1}$  rejected. Field (2013) suggested standards for levels of effect size ( $\omega^2$ ). The effect size of ( $\omega^2 = .04$ ) for this quasi-experiment falls between the small ( $\omega^2 < .01$ ) and medium ( $\omega^2 = .06$ ). A pairwise comparison was calculated to compare levels of novelty to determine where the variation exists within the variable reported novelty levels. Students with novelty level 4 had statistically different change scores than those at novelty level 2 ( $p = .006$ ) and students with novelty level 4 were different from those with a novelty level 5 ( $p = .012$ ). These results can be seen in Table 3.

Table 3

*Pairwise Comparison of Change Score (DV) by Novelty of Project (IV)*

---

(I)Novelty	(J) Novelty	Mean Difference (I-J)	Std. Error	<i>p</i>	<u>95% Confidence Interval for Difference</u>	
					Lower bound	Upper bound
1	2	4.31	4.40	.329	-4.39	13.00
	3	-1.75	3.95	.658	-9.55	6.06
	4	-6.98	3.75	.065	-14.39	.43
	5	.89	3.52	.800	-6.06	7.85
2	3	-6.06	4.13	.145	-14.22	2.11
	4	-11.29*	4.02	.006	-19.25	-3.33
	5	-3.41	3.84	.376	-11.01	4.18
3	4	-5.23	3.57	.145	-12.30	1.83
	5	2.64	3.33	.429	-3.94	9.22
4	5	7.88*	3.09	.012	1.76	13.99

---

Note: 1 = Definitely yes, 2 = Probably yes, 3 = Maybe, 4 = Probably not, 5 = Definitely not  
Duplicate comparisons have been removed.

\* The mean difference is significant at the .05 level.

---

Additionally, a Pearson Chi Square analysis was run to determine if a relationship between novelty and project type existed. The relationship between these two variables was determined to be significant,  $X^2(12, N=152) = 22.35, p = .034$ . It can be confidently said that the manipulation of the treatment affected the independent variable, as predicted.

### **Conclusions and Discussions**

The findings of this study run contrary to work reported by Larmer and Mergendoller that students need to be familiar with the project type to perform in a project-based system (2015). Students did not have to be familiar with the project type to be successful. It was found in this study that students who reported higher levels of novelty with the project type performed best of all.

The novelty of drawing a circuit, schematically, is something that is done in engineering but is not often done in high school agriculture classes. Students also have likely not participated in the squishy circuit activity. The Drawing and Squishy projects have the highest reported novelty with 65% of the Squishy, and 52% of the Drawing groups reporting that they had not participated in a project like this before. Likewise, 47.6% of the participants in the paper packet group and 43.4% of the wiring group said the same (Figure 2). The results of the Chi Square analysis upheld my postulation that the novelty level was related to the project type  $X^2(12, N=152) = 22.35, p = .034$  as the treatments were designed to do. Projects with higher levels of novelty also had statistically higher change scores on the MCAS physics assessment.

Upon interpretation, this novelty effect affects the focus participants gave to the project. That in turn, may have affected the amount of information students gained. These findings support assertions made by Carroll in his model of school learning (1963, 1989). In the model of school learning, the focus students give to study is one of the primary inputs that lead to academic achievement. The novelty likely played a part in the amount of time students were willing to spend on learning, which according to Carroll is the primary factor that determines the likelihood of student learning. If students perceived the project to be interesting due to its uniqueness, they might have paid attention longer, and thus learned more. Several other theories have been posited over the years that can add to the discussion of these results.

The von Restorff effect can typically be understood as applying to the effect of unique or novel stimuli on the memory of students. However, this theory is typically narrowly applied and has much wider application when discussions of uniqueness in education are being tested (Hunt, 1994). Applying von Restorff's (1933) theory of novelty across time, parallels could be drawn about the effect of novelty on this study. Rather than students needing to see items that are immediately different, as was done in her experiments, the differences could be over time. The change is less immediate; students see something they learned previously operated in a certain way operate in a new or novel way.

Another interpretation of novelty is the effects the uniqueness of the project had on the quantity of assumptions students had to put aside to operate within the new system they developed. In texts that focus on inquiry teaching of introductory sciences, time is spent on the development of

an understanding of systems (Dewey, 1938; Ethridge & Rudnitsky, 2003). Students must spend time becoming acquainted with the system to understand how what is presented is similar and dissimilar from the previously known. To be successful, students must interact with what they believe to be true, encounter something they do not believe or did not previously see as truth, and find a way to resolve the dissonance between the two (Festinger, 1957; Hewson & Hewson, 1984; Hewson, 1981). Cognitive dissonance or cognitive conflict has been considered important for decades as evidenced by the work of Dewey (1910; 1916), Festinger (1957), Piaget (1964), and Berlyne (1965). This cognitive dissonance was partly what spurred the learning forward in this study. This is not contrary to the initial concepts of transformative learning as suggested for adults by Mezirow (2000). Transformative learning, a normally andragogical theory, when applied to youth could explain part of the increase in scores for the students who reported the higher levels of novelty. Transformative learning theorists suggest that people who are confronted with ideas that conflict with their current understandings must shift their worldviews to either assimilate or reject the diverging knowledge.

Students in the 9th grade have a basic understanding of what a circuit is and what makes up a circuit. When introduced to the task of drawing a circuit, students were forced to interact with electricity in a more abstract fashion, which possibly created some form of dissonance. Likewise, squishy circuits created a dissonance with the system that is wiring simple circuits. Students were likely to understand circuits are wires, bulbs, and power supplies. The system of squishy circuits takes the system of wires, bulbs, and power, and in a certain sense, perverts the system. In the common understanding of the system known as circuits, wires are made of copper or another conductive metal, bulbs have threaded ends that fit female sockets, and batteries are attached via spring or hardware means. In the system known as squishy circuits, play-dough conducts electricity, bulbs are pushed in via needle-like protrusions and batteries have probes to electrify anything they touch. This system shift likely created a dissonance which students were forced to confront in order to complete the task. In the new system, conductors were anything that conducts (not just wires); loads were more than screw-bottom bulbs, and power sources were not just positive lock batteries. Students interacting with squishy circuits had to learn the proxies for the system. They had to learn how those proxies are understood in another context. That relearning forced them to see the parts for what they were in the system (a conductor, a load, a power source) rather than a wire, a bulb, and a battery.

Conversely, when wiring a circuit using traditional methods students interacted with a system they have previously encountered. Preconceived notions were upheld and no dissonance was created. They progressed through the project without having to think about how all of the parts worked together. This helps to solidify and support Dewey's (1910) model of problem-based experiential learning rather than Kilpatrick's (1918) various project models as spoken about in Stevenson (1925), and later in Moore (1988). The use of a problem led to the likelihood that students would encounter a dissonance. Students in a purely project-based lesson (i.e., one devoid of problems), can potentially perform the task successfully with no dissonance, as seems to be the case in the wiring treatment. Through problems, or with projects that lead to problems, students encounter the necessary dissonance.



In the context of this study, agricultural science teachers have the opportunity to provide the novel and hands-on activity that is different from what the students are experiencing in traditional science courses. Teachers should feel confident in using projects that challenge students understanding of how the information fits together. Additional experiments must be conducted to narrow down the underlying cause of the increase in knowledge when students have differing reported levels of novelty. In this study, no regard was paid to the development of skill or the effects disruptive teaching has on skill development. Those effects should be examined and decisions about methods made according to the desires or goals of the instruction.

## References

- Bandura, A. (1971). *Social learning theory*. New York, NY: General Learning Press.
- Bandura, A. (1977). *Social learning theory*. Upper Saddle River, NJ: Prentice Hall.
- Berlyne, D. E. (1960). *Conflict, arousal, and curiosity*. New York, NY: McGraw-Hill.
- Blackburn, J. (2013). *Assessing the effects of cognitive style, hypothesis generation, and problem complexity on the problem solving ability of school-based agricultural education students: An experimental study* (Doctoral dissertation). Retrieved from Digital Collections at Oklahoma State University.
- Blumenfeld, P. C., Soloway, E., Marx, R. W., Krajcik, J. S., Guzdial, M., & Palinscar, A. (1991). Motivating project-based learning: Sustaining the doing, supporting the learning. *Educational Psychologist*, 26, 369-398.
- Buriak, P. (1989). Incorporating agriscience into agricultural mechanics. *The Agricultural Education Magazine*, 63(9), 18.
- Carroll, J. B. (1963). A model for school learning. *Teachers College Record*, 64, 723-733.
- Carroll, J. B. (1989). The Carroll model: A 25-year retrospective and prospective view. *Educational Researcher*, 18(1), 26-31.
- Dewey, J. (1910). Science as subject-matter and as method. *Science*, 121-127.
- Dewey, J. (1916). *Democracy and education: An introduction to philosophy of education*. New York, NY: Macmillan.
- Dewey, J. (1938). *Experience in education*. New York, NY: Touchstone.
- Ethridge, S., & Rudnitsky, A. (2003). *Introducing students to scientific inquiry: How do we know what we know?* Boston, MA: Pearson Education.

- Festinger, L. (1957). *A Theory of cognitive dissonance*. Stanford, CA: Stanford University Press.
- Field, A. (2013). *Discovering statistics using SPSS: And sex and drugs and rock 'n' roll* (3rd ed.). Los Angeles, CA: Sage
- Greeno, J. G. (2006). *Learning in activity*. In R. K. Sawyer, (Ed.), *Cambridge handbook of the learning sciences*. (79-96). Cambridge, MA: Cambridge University Press.
- Hewson, P. W., & Hewson, M. G. B. (1984). The role of conceptual conflict in conceptual change and the design of science instruction. *Instructional Science*. 13(1), 1-13.
- Hewson, P. W. (1981). A conceptual change approach to learning science. *European Journal of Science Education*, 3(4), 383-396.
- Hillison, J. (1998). Agriculture in the classroom: Early 1900s style. *Journal of Agricultural Education*. 39(2). doi: 10.5032/jae.1998.02011
- Hunt, R. R. (1995). The subtlety of distinctiveness: What von Restorff really did. *Psychonomic Bulletin & Review*, 2(1), 105-112.
- Krajcik, J. S. & Blumenfeld, P. C. (2006). Project - based learning. In K. R. Sawyer (Ed.), *The Cambridge handbook of the learning sciences*. 317-333. Cambridge, MA: Cambridge University Press.
- Krajcik, J. S., Blumenfeld, P. C., Marx, R. W., & Soloway, E. (1994). A collaborative model for helping middle grade teachers learn project-based instruction. *The Elementary School Journal*. 94(5), 483-497.
- Krajcik, J. S., Czerniak, C. M., & Berger, C. F. (2002). *Teaching science in elementary and middle school classrooms: A project-based approach* (2nd ed.). New York, NY: McGraw Hill.
- Kilpatrick, W. H. (1918). The project method. *Teachers College Record*. 19(4), 319-335.
- Larmer, J. & Mergendoller, J. R. (2015). *Gold standard PBL: Essential project design elements*. Buck Institute for Education, Retrieved from: [http://bie.org/object/document/gold\\_standard\\_pbl\\_essential\\_project\\_design\\_elements](http://bie.org/object/document/gold_standard_pbl_essential_project_design_elements)
- Mezirow, J. (2000). *Learning as Transformation: Critical Perspectives on a Theory in Progress*. *The Jossey-Bass Higher and Adult Education Series*. San Francisco, CA: Jossey-Bass Publishers

- Moore, G. E. (1988). The forgotten leader in agricultural education: Rufus W. Stimson. *The Journal of the American Association of Teacher Educators in Agriculture*. 29(3), 50-58.
- Parr, B., & Edwards, M. C. (2004). Inquiry-based instruction in secondary agricultural education: Problem-solving-An old friend revisited. *Journal of Agricultural Education*. 45(4), 106-117. doi: 10.5032/jae.2004.04106
- Piaget, J. (1964). Part I: Cognitive development in children: Piaget development and learning. *Journal of Research in Science Teaching*. 2(3), 176-186.
- Reeves, T. C., & Reeves, P. M. (1997). Effective dimensions of interactive learning on the World Wide Web. *Khan*. 62, 59-66.
- Roberts, T. G., & Harlin, J. F. (2007). The project method in agricultural education: Then and now. *Journal of Agricultural Education*. 48(3), 46-56. doi: 10.5032/jae.2007.03046
- Samuels, S. J. (1986). Relationship between formal intralist similarity and the von Restorff effect. *Journal of Educational Psychology*. 59(6), 432-437. doi: doi.org/10.1037/h0026455
- Stevenson, J. A. (1925). *The project method of teaching*. New York, NY: MacMillan
- von Restorff, H. (1933). Ueber die Wirkung von Bereichsbildungen im Spurenfeld. Analyse von Vorgängen im Spurenfeld. I. Von W. Köhler und H. v. Restorff. *Psychologische Forschung*. 01(18), 299-342.

# **The School in Biltmore Forest: The Beginning of Formal Forestry Education in America**

D. Barry Croom, University of Georgia

## **Abstract**

The Biltmore Forest School was the first school to provide vocational forestry education in America. It was established at a time in American history when the Progressive Movement provided direction to education, public policy development, and social growth and development. Forestry education was created in response to the need for well-trained foresters to manage the public and private forests in America, and its early development was largely the result of efforts by Gifford Pinchot who uncovered the need for forestry schools and Carl Alwin Schenck who established the first forestry school in America – the Biltmore Forest School. It was the first school to teach forestry as a distinct field of study in the United States. It was also the first school to teach the principles of forest management in a lab setting with hands-on instruction. The Biltmore Forest School may also have been the first school in America to offer an undergraduate degree using distance education as the medium of learning. It was the first school to manage a privately owned forest in the United States for the distinct purpose of returning a profit.

## **Introduction**

The Biltmore Forest School was the model of innovation for forestry education in America in the late 1800's. It was the first school to teach forestry as a distinct field of study in the United States, and the first known school in America to offer an undergraduate degree using distance education as the medium of learning. The school was also the first to teach the principles of forest management in a lab setting with hands-on instruction, and was the first school to manage a privately owned forest in the United States.

Forestry is a field of study in agricultural education in the United States. Students in agricultural education can choose to enroll and natural resources and environmental sciences courses in school across America, and in these courses they will study some aspect of the forestry industry. From this study, students can learn the basics of the forestry industry and perhaps obtain employment as a forest technician, log grader, pulp and paper mill operator, or a host of other forestry related occupations, including the teaching of agriculture (National Career Technical Education Foundation, 2008; Newcomb, McCracken, Warmbrod and Whittington, 2004). The United States government also recognizes the firm relationship between forestry and agriculture. The federal government maintains a forest service within the United States Department of Agriculture, and has done so since 1905. In 2007, the United States Department of Agriculture Forest Service (USDAFS) managed 193 million acres of national forests and grasslands (USDAFS, 2007).

Forestry has been practiced for thousands of years. Roman emperors selected forest stands and protected them for use in times of national defense. Some forests were reserved for religious purposes. Regular culling and thinning of these forest stands occurred (Fernow, 1911). The improper and wasteful practices used in cutting timber were condemned in literature as early as 465 BC when Artaxerxes I attempted to regulate lumbering on Mount Lebanon. By 333 BC,

the cedars of Lebanon had been cleared from the Southern slope of the mountain as reported by Alexander the Great (Fernow, 1911). In the Christian Bible, the prophet Isaiah warned around 590 BC of the destruction of the great forests of Sharon, Carmel and Bashan (Metzger & Murphy, 1994). The first known text on plant history was probably prepared by Theophrastus (390-286 BC). The early writers of agricultural practices, Cato (234-149 BCE), Columella (4-70 AD) in *De Re Rustica* and *De Arboribus*, Varro (16-26 BCE) and Vergilius Maro (70-19 BCE) also wrote about the practice of healthy forest management.

The oldest attempts at extensive artificial reforestation did not begin until the eighteenth century. Frederick the Great ordered that government forests be administered by a forestry department in 1740. In 1817, the United States Congress enacted legislation to preserve public land in the Southeast for the production of naval stores. Forestry grew most rapidly and most extensively in Germany. Other countries soon followed Germany's lead. The French National Forest School began in Nancy in 1825. It was organized similarly to a military school. English men preparing to serve in the forests of India trained at the school (Fernow, 1911).

In 1873, the United States government began forestry work by setting aside \$2000 to study forest conditions in the United States and territories. In 1876, the United States Department of Agriculture surveyed forest resources in the United States. In 1887, Congress passed the Timber-Culture Act, requiring the planting and cultivating of a certain number of trees "as the consideration of a deed to a quarter-section" (Pinkett, 1970, p. 9) of the public domain. Yet, by 1890 there was still no systematic forest management plan to be found in American forests (Pinkett, 1970). In 1891, President Benjamin Harrison created the Yellowstone National Park Timber Land Reserve in Wyoming, and the White River Plateau Timber Land Reserve in Colorado. This resulted in 2.4 million acres of forest land being protected by the federal government. More than 17.5 million acres were subsequently set aside for Yellowstone, Yosemite, Sequoia, and General Grant parks. The forestry movement was gathering momentum in the United States by the end of the nineteenth century, but it would take the grandson of a steamship captain to propel forestry education efforts into the national consciousness.

### **Purpose and Procedure**

The purpose of this historical research project was to describe the events leading to the origin of forestry education in the United States. Historical research studies are useful for interpreting past events and how they influence the present (Rury, 2006). The historian examines artifacts and documents and makes inferences based on that examination. The essential element of historical research is interpretation. Gray (1964) proposed that all of our knowledge is based upon past experiences. Researching our past helps us to gain a better understanding of the present time. John Burrow, in *A History of Histories*, wrote that historical studies are "...a marker set down against the oblivion with which time threatens all human deeds." (Burrow, 2007, p. 11). This research project used primary sources of information such as personal correspondence, diaries, oral histories, manuscripts prepared by the individuals described in this paper, and data collected by state and federal agencies with responsibility for forestry education in the United States. Secondary sources included data from refereed journal articles and historical information available from established institutions. Secondary sources were compared

to selected primary sources to ascertain their accuracy. Sources of information were subjected to internal criticism for accuracy and external criticism for authenticity. Readers are cautioned to examine the findings of this paper from a historiographical perspective. History is not a science. As a form of art, it is relatively difficult to quantify the results of historical study (Wood, 2008). Critics of historical studies argue that this type of research has no bearing on the problems and concerns of the present time. This misrepresents the purpose of historical research, which is to represent the past within its own context (Wood, 2008). The present state of affairs in a particular society arrived after years of cultural evolution, experience and custom. This is what historian's study.

Because this project is intended to inform a cross-section of elements with the disciplines of agricultural education broadly defined, it is difficult to assign it to any particular research priority as defined by the American Association for Agricultural Education (AAAE) Research Agenda. To meet the requirement that this project be connected to one priority, we ask readers to consider it as focused on AAAE Research Priority 1: Public and Policy Maker Understanding of Agriculture and Natural Resources as defined in the AAAE Research Agenda as defined by Roberts, Harder and Brashears (2016). Because the AAAE Research Agenda is in itself a historical document and no longer indicative of emerging issues in agricultural education, the reader is cautioned to not place too much emphasis on how well this paper focuses on a research priority.

### **Agricultural and Natural Resources Education and Forestry**

One may wonder what a paper relating to the history of forestry is doing in the queue for a conference associated with agricultural education. Forestry is taught in high school agricultural education programs across the United States. National forests are managed by the United States Department of Agriculture (USDA). Extension specialists within the USDA provide information and guidance to owners of timberlands on the best uses of their timber resources. A number of colleges and universities in the United States blend together the disciplines of agriculture, conservation, forestry, and natural resources. Forestry education falls within the scope of the professions represented in the American Association for Agricultural Education.

### **The Establishment of the Biltmore Estate and Forest**

Malaria brought Maria Vanderbilt and her son George Washington Vanderbilt II to Asheville, North Carolina in the winter of 1888. Mrs. Vanderbilt had suffered from the disease for some time, and came to Asheville to recuperate as both the altitude and climate in the Southern Appalachians were esteemed by the affluent members of Eastern society as being especially healthy and restorative (Covington, 2006). George Vanderbilt was the grandson of Cornelius Vanderbilt, the multimillionaire owner of steamships and railroads in the Gilded Age of the late nineteenth century. Vanderbilt was a millionaire at birth through the generosity of his deceased grandfather, and by his twenty-six birthday, inheritances had increased his wealth to more than eleven million dollars.

During his stay in Asheville that first winter, George Vanderbilt explored the mountains and valleys South of Asheville, and developed an appreciation for the natural beauty of these southern highlands, eventually determining against his family's objections to build a summer home in the area. The weather in Asheville is temperate and pleasant almost year-round (National Oceanic and Atmospheric Administration, 2008), making this an excellent location for George's summer home. Vanderbilt eventually purchased 125,000 acres along the French Broad River south of Asheville North Carolina to establish the residence, formal gardens, and farms for his new estate – Biltmore (Chase, 2007). By the time Vanderbilt opened the doors to the Biltmore Estate in 1895, more than six years of construction has passed and many more were to come before the house was completely finished (Biltmore Corporation, 2008). Although the house and gardens consume several hundred acres, most of the estate was still covered in forestland as of 1893. Nature study was one of Vanderbilt's hobbies, but he had not observed forestry at work in any of the European countries he had visited, although he may have read about the subject in some of his gardening journals (Schenck, 1974). It was clear that he would need expert assistance to develop the gardens of Biltmore.

To construct these gardens, Vanderbilt engaged the services of Frederick Law Olmsted. Olmsted's charge was to create a horticultural park at Biltmore to rival New York's Central Park, with formal gardens, forests, and trails. Olmsted founded landscape architecture in the United States, and was the nation's foremost park builder in the late 1800's. New York's Central park, the Columbia Exposition at the Chicago World's Fair, and the Arnold Arboretum in Boston, Massachusetts were projects for the master landscape architect. Olmsted was an advocate for protective forest management at a time when forestry was not of interested to the American people. After a survey of the forests surrounding Biltmore, Olmsted declared them a disaster. The previous landowners, Appalachian mountain families, had resorted to cutting all of the best species timber, leaving inferior species in the wake. Cattle were often grazed on deforested slopes causing erosion, destroying the soil structure, while trampling down and eating foliage (Pinkett, 1970). Vanderbilt had originally planned to have all of the estate as a park, but Olmsted convinced him to manage most of the property as forests (Alexander, 2005). He believed that carefully managed forests attracted people and made areas more favorable for settlement, and understood the impact that forests had on the quality of the water supply. However, Olmsted was too busy developing the formal landscape around Biltmore as well as his other projects. The estate needed a professional forester. Olmsted was looking for someone who carried the same attitude of social responsibility as he did, to manage Biltmore using the concepts of scientific forestry. In 1891, Olmsted recommended that Vanderbilt hire a promising young forester, Gifford Pinchot.

### **Gifford Pinchot**

Pinchot learned the value of forestry from his father, who earned his fortune speculating in land and timber interests. James Pinchot dabbled in forestry as a hobby, but it was his son Gifford who saw it as a promising career (Balough, 2002). Because he was independently

wealthy, he could pursue the potentially risky career of forestry (Meyer, 1997). While his brother Amos managed the family business, Gifford went to Yale University for courses in meteorology, botany, geology, and astronomy which were all useful, but Yale did not offer forestry courses in the 1880's, nor did any other American school or university (Pinkett, 1970).

In 1884, Pinchot met Sir Deitrich Brandis, former inspector general for the British government's forests in India. At Brandis' recommendation, Pinchot entered the French National Forest School at Nancy. He studied silviculture, forest economics, and forest law. The forests surrounding Nancy were managed like a field crop and protected from wildfire and harmful harvesting practices. Pinchot also had the opportunity to study under Brandis for six months, a highly experienced forester who knew the value of scientific forestry (Balough, 2002). Pinchot came to realize that conservation was the key to forest management and economic progress. In order for forest conservation to work, forest management must first protect and preserve natural resources. Second, forest resources should be used for the common good of all citizens, and Third, private industry must be prevented from monopolizing natural resources (Meyer, 1997). At any rate, Pinchot cut short his education at the national forest school in Nancy and returned home to promote scientific forestry in Biltmore Forest.

Pinchot fell into his work with a passion, calling Biltmore Forest "the first practical application of forest management in the United States. (Pinchot, 1893, page 5). Pinchot traveled by horseback through the highlands, cataloging 72 tree species on the estate and assessing the condition of the forests (Pinchot, 1893). Unrestrained cutting had decimated valuable tree stands, and the uncontrolled grazing of livestock on the clear-cut mountain slopes destroyed new seedling growth. Soil erosion in clear-cut areas threatened to carry away the thin layer of nutrient-rich topsoil necessary for healthy plant growth. The indigenous population of Southern Appalachia was comprised of farmers scratching out a living on small farm plots and grazing livestock wherever the best forage existed. For these highlands people, the forest provided food, shelter and warmth. Their lack of understanding of forest management coupled with the lack of a consistent government policy for forest use meant that forests were in significant danger.

Pinchot began a series of improvement cuttings and newly graded roads designed to curb soil erosion. His greatest challenge was in getting the mountaineers on his work crews to follow his scientific forestry practices. Selective cuttings of low grade species yielded cordwood and firewood while protecting the more valuable species. He constructed a sawmill to make construction grade lumber. The cordwood and lumber initially coming out of Biltmore's forests was of inferior quality, and did not compete well with other logging operations in the area. Pinchot sold most of the first year's production back to the estate to feed the furnaces of the brick kilns, the railroad and to the farm departments. The forestry department lost \$392.00 in the first year (Pinchot, 1893). In spite of setbacks in the first year, Pinchot continued to have the full support of Vanderbilt. "Mr. Vanderbilt recognizes as fully as I do the educational value of the work and is disposed to do everything to side that side of it prominence and force (Pinchot, 1892).



Vanderbilt eventually purchased much of Pisgah Forest south of Asheville, and there Pinchot began large scale forestry operations. The area was primarily old growth forest and had not yet been managed for timber production. By December 1893, the forestry department had made a small profit of \$1220.00 for Biltmore. Regardless of the unimpressive profit margin and the difficulties of managing long-neglected woodlands, the improvement cuttings undertaken by Pinchot in that first year had significantly improved the timber stand and accelerated favorable tree growth. The overall health of the forest had been improved by Pinchot's scientific forestry. Because of the innovative work at Biltmore Forest, men interested in studying forestry were applying to Pinchot for work. Biltmore had acquired the reputation as the center of forestry in America. Foresters and forestry students came to Biltmore to learn practical and scientific forestry. So many potential students applied that Pinchot was eventually forced to use form letters to answer inquiries.

Unfortunately for Pinchot, Vanderbilt's preoccupation with business matters had reduced his interest in scientific forestry. On February 22, 1895 Pinchot wrote to his old mentor Brandis, "The scientific value of this place does not seem to appeal to Mr. Vanderbilt as much as it did, nor as far as I see does he realize at all the ways in which a useful result in this direction is to be obtained (Pinchot, 1895)." Pinchot left Biltmore in 1895 to work in the division of forestry in the United States Department of Agriculture. Before leaving he sought out Brandis again for advice on his replacement, so that the work at Biltmore would continue. Brandis had just the person in mind, a young German protégé by the name of Carl Alwin Schenck.

### **Carl Alwin Schenck**

Carl Alwin Schenck learned the value of practical forestry from Brandis (Schenck, 1974). Schenck graduated from the Institute of Technology in Darmstadt, Germany at age 18, but was unable to continue his studies in forestry at a university. Brandis was a strong force in the life of the young Prussian student. He helped Schenck form most of his thinking and attitudes about forestry, Brandis believe that the "best college should be a college on wheels (Schenck, 1974, p. 10)." Brandis was instrumental in bringing forestry to Great Britain, installing it in the Indian colonies, and training virtually every forester of note along with his colleague Sir William Schlich, director of the English-Indian visitor program in Germany. When Brandis retired in 1891, Schenck became Schlich's secretary, and was working for Schlich in 1894 when he received a letter from George Vanderbilt asking him to come to America to run the Biltmore Forest.

"Your letter dated New York January 24, 1895 reached me here, occupied in studying the forestry of Southern France. Sir D. Brandis who very often told me about your interesting business at Biltmore, has not yet given me his impression of the situation as you call it. You will easily understand that my definite resolution depends on his advice... I hope very seriously that he will advise me to accept your proposition. For the work awaiting me at Biltmore is as far as I can see a most interesting one (Schenck, 1895)."

Brandis had a favorable opinion of Pinchot and his work, and recommended that Schenck take the job at Biltmore. Schenck arrived in the United States on April 8, 1895 in the employ of

George Vanderbilt. At Schenck's arrival, Biltmore forest was mostly a conglomeration of old worn out farms. Although Pinchot efforts to manage the forest more effectively had borne fruit, more than 100 years of mismanagement had allowed the grow and production of weak tree species at the expense of healthy more merchantable tree species. Soil erosion continued to be a problem, and the lumbermen in the region stubbornly refused to adopt Pinchot's new management program. Pinchot's program for forest renovation had begun to turn the tide of mismanagement of the forest resources at Biltmore, but there was much more work to be done (Schenck, 1974). Schenck began reforestation efforts, road building in Biltmore Forest, and a series of logging and sawmill operations.

### **The Biltmore Forest School**

In that first year at Biltmore, Schenck began to give lectures to forestry apprentices at Biltmore on rainy days when they could not work in the forests. The forest division office served as a makeshift classroom. Schenck saw this as a way to improve the quality of forestry, but encouraging the adoption of better practices. In his memoir, Schenck referred to forestry as "common sense applied to woodlands (Schenck, 1974, page 27). Sharing his common sense with apprentices was more than an opportunity; it was an obligation in Schenck's eyes. He used apprentices to cruise timber. In their work, they often peppered Schenck with questions related to the growth, harvest, and marketing of timber. After two years of lecturing apprentices, Schenck was ready to begin his school at Biltmore in 1898.

The school followed a plan involving lectures in the morning and fieldwork in the afternoon. Schenck followed Brandis' policy of providing instruction in the environment best suited for it, so the school often convened on horseback or on the forest floor. Schenck paid Vanderbilt one-half of the profits from the school, in keeping with his policy of giving Vanderbilt one-half of all consulting and agent fees he earned per his contract.

Schenck found that experience was the best teacher, and encouraged all of his students to spend as much time as practical in the woods or the lumberyards, and that they should do this before entering federal service where opportunities for this type of experience might not exist. "Forestry is a factory of trees based on an investment in trees, roads, logging facilities, teams, wagons, houses for employees, sawmills, lumberyards, and so on... (Schenck, 1974, p. 68).

Students had to learn all aspects of the industry during the one-year course of study and six-month internship (Alexander, 2005). Lectures were plentiful on all subjects related to forestry, but there were no lessons on physics, mechanics, chemistry, zoology, mineralogy, nor did students get sociology or law. Thus, the Biltmore Forest School was more for students who already had this type of coursework completed at other universities. Schenck believed that the school offered a specific and high quality education in forestry, and did not attempt to compete with other schools offering a broader curriculum, primarily because he believe that such broad schooling was not necessary. In a letter to Gifford Pinchot, he wrote, "How gladly I would exchange all of my knowledge of entomology, pathology, chemistry and mineralogy for the knowledge which my mill foreman or logging foreman possess." (Schenck, 1903a).

Schenck brought a host of notable speakers to the Biltmore Forest School. F.W. Newell, head of the United States Reclamation Service, spoke on irrigation practices, Collier Cobb, University of North Carolina; lectured on geology, St. George Sioussat, University of the South, spoke on economic issues (Lauderburn, 1907). A 1901 circular to attend the Biltmore Forest School listed expenses as five to ten dollars weekly for food, six dollars monthly for horses and 200 dollars yearly for tuition. In 1902, to encourage enrollment, Schenck offered a three-month trip through European forests for 350 dollars per student (Schenck, 1974). The Biltmore Forest School graduated 300 students between 1898 and 1913. Many of these “Biltmore Immortals” as Schenck called them, became prominent foresters in government agencies and private industry (Alexander, 2005).

As the Biltmore Forest School grew, so did competition from other schools. By 1897, forestry education had been added to the curriculum in more than 20 universities. The first real attempt at a technical forestry course was at the Massachusetts College of Agriculture in 1887 (Fernow, 1911). Bernhard Fernow organized the forest school at Cornell University. The New York State College of Forestry at Cornell opened at approximately the same time as the Biltmore Forest School. One year later, in 1899, Gifford Pinchot helped finance and organize the School of Forestry at Yale University (Fernow, 1911; Graves, 1945). By 1903, the University of Michigan had opened a school of forestry.

In addition to the competitive pressure brought about by other forestry schools, the critics of the Biltmore Forest School began to apply pressure as well. One critic in particular was Gifford Pinchot. Pinchot was establishing himself as head of the forestry division in the United States Department of Agriculture, and he was deeply concerned about the future of American Forests. Pinchot knew that the forest owner can earn more returns in the short term through ordinary lumbering, but he also knew that the application of scientific forestry provided a higher quality sustainable yield over time. The private forest owner is most interested in a financial return to land, labor, capital and management, and the whole process of scientific forestry depended upon the strength of these financial returns. To get landowner’s to adapt scientific methods of forestry, they must be convinced that the methods are practiced, simple, and thoroughly carried out (Price, 1902). To Pinchot, the best use of the field laboratory at Biltmore was not as a degree-granting school.

In the summer of 1903, Schenck had written to the editor of *Forestry and Irrigation*, H.M. Suter, to propose that the Biltmore Forest School offer the Bachelor of Forestry and the Bachelor of Forest Engineer degrees to those who passed the examination requirements at the end of their year of study at the school. Suter passed this information on to Pinchot who disagreed strongly with the notion of the Biltmore Forest School as a degree granting school. Pinchot was trying to establish forestry education at Yale University, and the Biltmore Forest School was a serious threat to its success. On July 20, 1903 Pinchot sent Schenck a copy of a letter he had sent to George Vanderbilt encouraging him stop the Biltmore Forest School from granting degrees.

“It is not for me a question of whether Biltmore Forest has been or can be useful to forestry in the United States for I entertain no doubt of its great value, but rather a

question of how it can contribute most to that general progress in which we are all interested. I am satisfied that its line of greatest usefulness does not lie in the school, but in utilizing the opportunity for field study which it affords to them who already have some idea of forestry and are anxious to put themselves more completely in touch with certain phases of its practice on the ground.” (Pinchot, 1903b)

Pinchot’s letter to Vanderbilt explained his opposition to the Biltmore Forest School in very plain terms. The school’s master, Schenck, had not collaborated enough with others in forest work and thus the school could not pretend to offer a relevant curriculum. Schenck was isolated from the forestry movement while at the Biltmore Forest School, and was not sympathetic to the work of the United States Forest Service now in progress. Pinchot further explained that the Biltmore Forest School was a practical training ground for foresters, and not sufficiently rigorous enough to serve as a prep school. As such, the school could not compete successfully with the professional schools now springing up in colleges and universities. Pinchot ended his letter by asking that the Biltmore Forest School be discontinued, and that the forest be preserved as a working forest laboratory (Pinchot, 1903a).

Schenck wrote back to Pinchot in Washington while in the field at Davidson’s River, NC. In his response, Schenck explained to Pinchot that degrees at the Biltmore Forest School would be awarded sparingly, and only to those who had successfully completed examinations. Schenck reminded Pinchot that a number of students were in Pinchot’s employ at the United States Forest Service, and their education came from a highly qualified and superior forester. Certainly, Schenck explained, he was a much better professor than the faculty at the Harvard or Yale Forestry Schools. Besides, Schenck explained, George Vanderbilt himself does not hold a college degree, so what is the problem with the Biltmore Forest School awarding a few degrees on its own? Schenck’s letter to Pinchot on July 31, 1903 explains Schenck’s view on the matter:

“As regards employment in government service, I fully see the advisability of employing only college graduates. The Biltmore Forest School does not intend to prepare young men for government service. It intends to prepare them for practical technical tasks, especially the management of forests owned by private individuals... I am trying and have tried hard to invite, especially the sons of wood-owning lumbermen to come to Biltmore because, here, I think, the means and ends of real forestry are practiced... (Schenck, 1903a)

Schenck finishes his letter to Pinchot with an invitation to come down to Asheville and see the school for himself. “I shall be greatly indebted to you for any advice which in connection with my work you think fit to give *after* [emphasis by Schenck] such an inspection. (Schenck, 1903b). In the end, the argument was settled by George Vanderbilt.

Market reversals in investments caused Vanderbilt to lose a fair portion of his fortune in 1901 and 1902, and he had to cut back on the operational expenses of Biltmore. Thus, Biltmore had to begin making money. Financial troubles at Biltmore also slowed the progress of the forestry program. The school had no large donors. Yale received numerous gifts and began to grow an endowment for professorships. Vanderbilt’s financial crisis had reached severe proportions, even requiring reductions in Biltmore house staff (Schenck, 1974).

On Saturday, April 24, 1909, the Biltmore Forest School at Biltmore Estate came to an abrupt end. Furthermore, trouble had been brewing for months with C.D. Beadle, the estate superintendent. On that Saturday, Beadle accused Schenck of lying to Vanderbilt about some financial matter, and Schenck struck him several times before Beadle's assistants were able to separate the two men. Schenck was charged with assault and battery and fined one dollar. (Schenck, 1974) The fight with Beadle had been published in the papers across the country, bringing negative press on the Vanderbilts. Vanderbilt was also angry when Schenck made contract for the use of Biltmore Forest when Schenck knew that Vanderbilt was trying to sell the forest (Schenck, 1974). Vanderbilt fired Schenck in 1909, forcing Schenck to move his school out of Biltmore Forest to the adjacent town of Sunburst, North Carolina and into buildings provided by the Champion Lumber Corporation (Maunder, 1959).

The Biltmore Forest School continued for four more years as a distance education program, and Schenck established six working fields in Germany, France, New York State, North Carolina, Michigan, and Oregon. Students moved from field to field, inspecting forest operations and completing lab exercises. Schenck was appointed to the position of assistant professor at the Darmstadt Tech, and began an association with that school and the Biltmore Forest School. Schenck kept the school alive in the post-Biltmore years by selling textbooks, writing bulletins, and collecting student tuition for the traveling school (Schenck, 1974). Finally, low enrollment forced Schenck to close the traveling school on January 1, 1914 with the last issue of *Biltmore Doings*, a chronicle of the Biltmore Forest School odyssey. By the time the school closed shop, there were 83 American colleges and universities teaching forestry, and 21 other technical forestry schools in operation.

### **Conclusion and Discussion**

It is unusual that the Biltmore Forest School ever existed. The rising tide of Progressivism and the advocacy for worker's right and social justice in the United States demanded such schools as the one at Biltmore Estate, but Biltmore was the Elysian Fields of the grandson of Cornelius Vanderbilt, one of America's most famous "robber barons", representing the anti-thesis of the progressive movement. That such a school could survive at all in this environment is a testament to the work of its founder Carl A. Schenck, and in large portion to the commitment of George Vanderbilt II to the study of natural resources.

Notwithstanding this, much of the Biltmore experiment failed. Plantings failed, logging techniques failed, and the school itself failed. Forestry was indeed a new and untried science in America. The role of forestry education was also unclear at the beginning of the twentieth century. Gifford Pinchot theorized that forestry should be taught with conservation at its foundation. Pinchot believed that forest education should teach principles of management that caused the forests to be useful to mankind without total consumption. Schenck held the antithetical view that no forest was of value unless it could be used for lumber production. "Nothing can be conserved that isn't worth conserving." (Schenck, 1974, p. 13). Schenck believed that the Division of Forestry in the United States Department of Agriculture had too narrowly defined the practice of forestry as silviculture. Schenck's theory was that forestry was "common sense applied to woodlands" (Schenck, 1974, p. 27), and as such forestry education must include lumbering and sawmill operations. In his last letter to Biltmore Forest School

students and alumni, Schenck explained that forests could not expect to be conserved unless they could pay for themselves in some fashion. Virgin forests were worthless in their present state. Only by being logged could forests hope to ensure their continued presence (Schenck, 1914). He believed that national forests were being overprotected, and thus being maintained at a loss (Schenck, 1955).

In retrospect, the Biltmore Forest School provided a strong vocational education experience for young men in a period of American history when they could provide the greatest service to forests. However, the concept of forest education was too useful to be reserved solely for schools like the Biltmore Forest School, and the explosion of forestry education in American in the early twentieth century and the resulting competition from these other schools was the true cause of the school's demise. The school served a useful purpose, but its curriculum only touched part of the larger purpose of forestry education. What then, was this larger purpose?

In 1893, the Columbian Exposition opened at the Chicago World's Fair. The Biltmore forest exhibit was the first forestry education exhibit in the United States (Goodwin, 1968; Pinkett, 1970), and it was designed by Gifford Pinchot. Pinchot's exhibit detailed the efforts of scientific forestry in the Biltmore experiment; efforts directed toward the goals of production at a profit, renewable and consistent annual yield, and general forest improvement. Almost 114 years later, the United States Forest Service released an almost identical strategic plan for fiscal years 2007 through 2012. This plan details the conservation of forests, protection of grasslands, and the sustainability for forests for public recreational use and timber production (USDAFS, 2007).

In 1914, the year that Schenck closed the Biltmore Forest School, George Vanderbilt died unexpectedly, leaving the estate to his widow Edith. Edith Vanderbilt eventually sold the forest to the United States Forest Service where through subsequent land acquisitions it grew to 510,119 acres by 2008 (Forest History Society, 2008). Schenck returned to Germany and served in the German Army on the Russian front during World War I. After the war, he continued to teach forestry and serve as a consulting forester until his death in 1955. Pinchot served as chief of the forestry division in the United States Department of Agriculture, and governor of Pennsylvania. He died in 1946.

## References

- Alexander, B. (2005). The first American forest. *American Forests*, 2005 (Summer), 4.
- Balough, B. (2002). Scientific forestry and the roots of the modern American state. *Environmental history*, 2002(April).
- Biltmore Corporation. (2008). Biltmore House Construction. Retrieved May 31, 2008.
- Burrow, J. W. (2007). *A history of histories: epics, chronicles, romances and inquiries from Herodotus and Thucydides to the twentieth century*. London: Allen Lane.
- Chase, N. K. (2007). *Asheville: a history*. Jefferson, N.C.: McFarland & Co.

- Covington, H. E., & Paul H. and Ethel M. Harvey Library Endowment. (2006). *Lady on the hill : how Biltmore Estate became an American icon*. Hoboken, N.J.: John Wiley.
- Fernow, B. E. (1911). *A brief history of forestry*. Toronto: University of Toronto Press.
- Forest History Society. (2008). "The National Forests of the United States." Retrieved May 28, 2008, 2008, from <http://www.foresthistory.org/Research/usfscoll/places/National%20Forests%20of%20the%20U.S.pdf>.
- Goodwin, O. C. (1968). *Eight decades of forestry firsts: A history of forestry in North Carolina (1889-1969)*. Raleigh, NC: North Carolina State University.
- Graves, H. S. (1945). Early Days With Gifford Pinchot. *Journal of Forestry*, 43(8), 4.
- Gray, W. (1964). *Historian's handbook, a key to the study and writing of history*. Boston: Houghton Mifflin.
- Lauderburn, D. E. (1907). *Biltmore Doings*. Asheville, NC: Biltmore Forestry School.
- Maunder, E. R. (1959). Oral History Interview with Reuben B. Robertson and E. L. Deamon. Forest History Foundation, Inc.
- Metzger, B. M., & Murphy, R. E. (Eds.). (1994). *The Oxford Annotated Bible*. New York: Oxford University Press.
- Meyer, J. M. (1997). Gifford Pinchot, John Muir, and the boundaries of politics in American thought. *Polity*, 30(2), 17.
- National Career Technical Education Foundation. (2008). *Agriculture, Food & Natural Resources - Natural Resources Systems*. Washington, DC: Author.
- Newcomb, L. H., McCracken, J. D., Warmbrod, J. R., & Whittington, M. S. (2004). *Methods of Teaching Agriculture*. Upper Saddle River, NJ: Pearson Prentice Hall.
- National Oceanographic and Atmospheric Administration. (2008). "NOAA Central Library: U.S. Daily Weather Maps Project." Retrieved May 28, 2008, from [http://docs.lib.noaa.gov/rescue/dwm/data\\_rescue\\_daily\\_weather\\_maps.html](http://docs.lib.noaa.gov/rescue/dwm/data_rescue_daily_weather_maps.html).
- Pinchot, G. (1892). Personal correspondence to Sir Deitrich Brandis.
- Pinchot, G. (1893). *Biltmore Forest*. Chicago: The Lakeside Press.
- Pinchot, G. (1895). Personal correspondence to Sir Deitrich Brandis.
- Pinchot, G. (1903). Personal correspondence to George Vanderbilt II, July 20, 1903.

- Pinchot, G. (1903). Personal correspondence to Carl. A. Schenck, July 21, 1903.
- Pinkett, H. T. (1970). Gifford Pinchot, private and public forester. Urbana, IL: University of Illinois Press.
- Price, O. W. (1902). America's Private Forests. *Harpers Weekly*, 1902 (July), 5.
- Roberts, T. G., Harder, A., & Brashears, M. T. (Eds). (2016). American Association for Agricultural Education national research agenda: 2016-2020. Gainesville, FL: Department of Agricultural Education and Communication.
- Rury, J. L. (2006). Historical research in education. *Handbook of complementary methods in educational research*. J. L. Green, G. Camilli and P. B. Elmore. Mahwah, NJ: Lawrence Erlbaum Associates, Publishers.
- Schenck, C. A. (1895). Personal correspondence to George Vanderbilt II, February 5, 1895. Menton, France.
- Schenck, C. A. (1903). Personal correspondence to Gifford Pinchot, July 31, 1903. Davidson's River, NC.
- Schenck, C. A. (1903). Personal correspondence to Gifford Pinchot, August 7, 1903.
- Schenck, C. A. (1914). *Biltmore Doings for 1914*. Darmstadt, Germany: Biltmore Forest School.
- Schenck, C. A. (1955). *The Biltmore story; recollections of the beginning of forestry in the United States*. St. Paul: American Forest History Foundation, Minnesota Historical Society.
- Schenck, C. A. (1974). *The birth of forestry in America: Biltmore Forest School, 1898-1913*. Santa Cruz, CA.: Forest History Society.
- United States Department of Agriculture Forest Service (2007). *USDA Forest Service Strategic Plan FY 2007-2012*. Washington, DC: Author.
- United States Department of Agriculture Forest Service. (2008). *National Forests in North Carolina*. Retrieved July 22, 2008, 2008, from <http://www.cs.unca.edu/nfsnc/index.htm>
- Wood, G. S. (2008). *The purpose of the past: Reflections on the use of history*. New York: The Penguin Press.



## **Organizational Priorities for Advancing Cooperative Extension in the Tampa Bay Area**

Amy Harder, University of Florida  
Lendel K. Narine, University of Florida  
Ondine Wells, University of Florida

### **Abstract**

Determining strategies for success within the urban environment is necessary for Cooperative Extension to accomplish its mission of improving the welfare of individuals, families, and communities, particularly given the large percentage of Americans who now reside in or near cities. Three levels of needs exist within a system such as Extension: primary user, service provider, and system resources. A needs assessment was conducted in 2016 and 2017 to assess the system resources of UF/IFAS Extension in the Tampa Bay area, as perceived by the county faculty and staff working there. All counties uniformly agreed that the highest priority needs were for additional resources, such as additional staff, a better external communications plan, and additional locations in the community to provide programming. UF/IFAS Extension will need to acquire new resources or reallocate existing resources in order to better equip its agents to be successful serving urban clientele, which may require adopting new funding models to ensure the future viability of the organization.

### **Introduction**

Rural-urban migration has resulted in rapid urban growth. In Florida, approximately 88% of the population lived in urban areas in 2013 and continued urban population growth is expected (Florida Department of Transportation, 2015). As a result, the efficient allocation of urban resources is of concern to urban dwellers, policy makers, and urban service providers, including the Cooperative Extension Service.

Several challenges face Extension programs in urban areas. Traditional Extension programming is based on the values and norms of rural communities (Webster & Ingram, 2007). However, urban communities tend to hold a diverse mix of cultures, attitudes, and norms. These factors play a significant role in planning and delivering Extension programs (Webster & Ingram, 2007). Additionally, Extension is challenged by limited financial resources due to declining budgets, a lack of awareness of Extension in urban areas, inadequate networks and partnerships between Extension and urban agencies, and limited overlap of priority issues specific to an urban context (Borich, 2001). On the centennial of Extension, Henning, Buchholz, Steele, and Ramaswamy (2014) highlighted the need for Extension to serve urban clientele by adapting its programming, methodologies, and approaches to meeting the challenges of non-traditional audiences. Determining strategies for success within the urban environment is necessary for Extension to accomplish its mission of improving the welfare of individuals, families, and communities (Rasmussen, 1989).

## Theoretical Framework and Review of Literature

Given limited resources, Extension must seek to prioritize efforts to remain competitive and relevant to urban audiences. Witkin and Altschuld (1995) noted a needs assessment is the most effective way to decide on resource allocation in organizational planning. A comprehensive and valid needs assessment allows for shared involvement in prioritizing organizational needs and designing suitable actions to address these needs. Kaufman (1988) described a need as a difference between current and desired results or consequences. Witkin and Altschuld (1995) expressed a need as the discrepancy or gap between *what is* (present output) and *what should be* (desired output).

Organizations must continuously monitor their progress to ensure deviations from expected performance and actual performance are minimized and eventually eliminated. A needs assessment allows organizations the ability to recognize such discrepancies in performance standards through an evaluation of the normative needs of the organizational system. Normative needs are value judgements based on resources available to solve problems of the organization (Boyle, 1981). Therefore, Witkin and Altschuld (1995) formally described a needs assessment as “a systematic set of priorities undertaken for the purpose of setting priorities and making decisions about program or organizational improvement and allocation of resources” (p. 4). The identification of needs is one component of a valid needs assessment, however, its ultimate purpose is to guide policy and program decisions necessary for system improvement (Witkin & Altschuld, 1995).

Boyle (1981) described a need as tension based on Lewin’s (1939) field theory of motivation. The theory posits a system’s natural state is equilibrium and a need represents tension which results in disequilibrium. If tension causes deviation from the natural state, then there is a strong tendency or motivation to return to the natural state of equilibrium by correcting or satisfying the need (Burnes & Cooke, 2012; Weiner, 1972; Wheeler, 2008). People within the system are motivated to correct for the discrepancy because movement away from the natural state is unpleasant (Weiner, 1972).

Three levels of needs exist within a system: primary user, service provider, and system resources (Witkin & Altschuld, 1995). Within the organizational system, the three levels of needs interact and are interdependent on each other. Therefore, discrepancies at one level can have an effect on another (Witkin & Altschuld, 1995). The needs assessment conducted in this study focused on the system resources required to serve urban Extension clientele, as shown in Figure 1. A needs assessment focused on system resources considers the adequacy or capacity of system resources in relation to the needs of service providers and end-users. System resources are the physical infrastructure, policies, procedures, programs, and program delivery mechanisms of the organization (Witkin & Altschuld, 1995). This type of needs assessment can examine the service delivery mechanisms and policies implemented to serve end-users such as urban residents, while revealing gaps in Extension program coverage and delivery due to current system resources.

Boyle (1981) stated the challenge of identifying underlying needs is accumulating the evidence required to compare the present situation to the desired state. Based on [State’s] Strategic Plan for Urban Extension, the needs assessment sought to identify needs within four frameworks:

institutional, resources, implementation, and partnership. Figure 1 illustrates a conceptual gap between the present and desired situations, identified as the area of need. In the present situation, Extension utilizes existing system resources to serve target audiences. However, the literature indicates a deficiency in Extension’s ability to serve urban audiences (Borich, 2001; Henning et al., 2014; Webster & Ingram, 2007). Therefore, the desired situation is hypothesized as the optimal use of resources to serve all audiences. Examining the gap between the current and desired situations can inform the development of appropriate policies to close the gap and improve service to urban audiences.

In the Western states, Stienbarger (2005) noted Extension’s ability to meet clientele needs is influenced by increased constraints of funding, staffing, and facilities. Further, inflexibility of Extension programming restricts agents’ responsiveness to meeting the dynamic needs of non-traditional audiences (Stienbarger, 2005). Stienbarger expressed the need for stronger partnerships with other governmental agencies to attract funding and support for Extension programming to serve a changing audience.

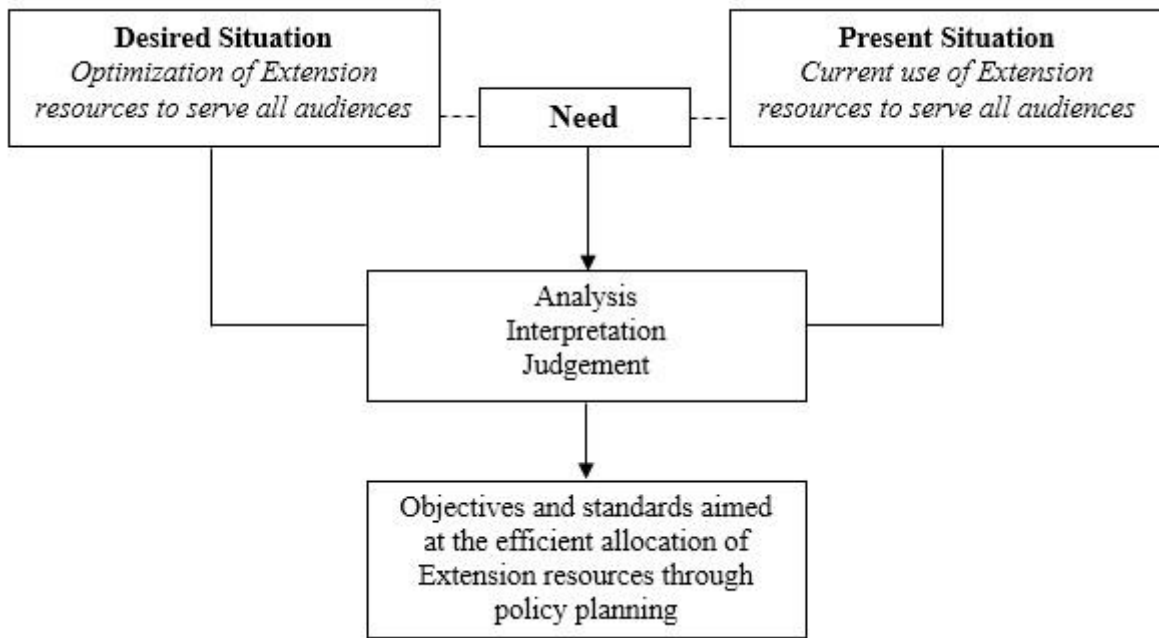

Figure 1. Analyzing, interpreting and judging the gaps in Extension frameworks.

A high priority initiative of the [State] Extension Roadmap is strengthening urban and rural communities, yet Harder, Lamm, and Strong (2009) found Extension faced several challenges to conducting quality programming at the county level. Challenges included a marketing deficit where stakeholders connected Extension to a person, rather than the university, and an “antiquated” (Harder et al., 2009, p. 15) view of Extension by stakeholders, exacerbated by the changing demographics. External threats to quality programming included budgetary uncertainties, increasing urbanization, and a lack of connection to urban clientele. Harder et al. (2009) noted non-traditional audiences lacked awareness of Extension and urban residents

historically have not advocated for Extension programming. As such, Extension funding is threatened because of its perceived irrelevancy to non-traditional audiences (Extension Committee on Organization and Policy [ECOP], 2007; Murray, 2005).

While funding affects the institutional framework and implementation efforts needed for urban Extension programming, partnerships with diverse agencies are also important to its success. Peters (2002) stated Extension has the experience needed to build partnerships with relevant agencies. Given the complexity of urban environments, Extension should seek partnerships with urban entities - including its competitors - in order to meet the diverse needs of urban audiences (Ruemenapp, 2017).

### **Purpose**

The purpose of this study was to assess the system resources of UF/IFAS Extension in the Tampa Bay area, as perceived by the county faculty and staff working there. The objective was to describe perceptions of priority organizational needs by county. Describing those perceptions of priority organizational needs by county will facilitate data-driven decisions regarding the allocation of system resources to support urban Extension in the Tampa Bay area.

### **Methods**

The findings here are part of a larger assessment of UF/IFAS Extension in the Tampa Bay area. The descriptive study reported here focused on the identification of system resources needs that were perceived as priorities for action within the next twelve months. A census of county faculty and selected staff within the three counties comprising the Tampa Bay area was attempted. County Extension Directors were responsible for identifying which staff should be included; all faculty were automatically included. There were 25 potential respondents.

Data collection was conducted using an online questionnaire hosted by Qualtrics. The original instrument was researcher-developed based primarily on elements within UF/IFAS Extension's strategic plan for Urban Extension, which is divided into four frameworks: Institutional, Resources, Implementation, and Partnership. Several additional items were added based on priorities identified by county faculty and staff during interviews conducted in the larger assessment. Using elements directly from the Strategic Plan was intentional to help establish construct validity, while including the additional items suggested by county faculty and staff in the interviews contributed to establishing face validity. The instrument was submitted to the Institutional Review Board at the University of Florida and was determined to be exempt.

Participants were asked to rate the degree to which 48 items were priorities for action in the coming year. There were two items within the Institutional Framework, 25 items within the Resources Framework, 13 items within the Partnership Framework, and 8 items within the Implementation Framework. Response options for each item were: (a) *very low priority*, (b) *somewhat low priority*, (c) *moderate priority*, (d) *somewhat high priority*, and (e) *very high priority*. Participants were also provided with an open-ended question to which they could add any other information not otherwise captured by the instrument. Using Qualtrics' mailing feature enabled the identification of respondents' counties.

Data collection occurred in April and May 2017. Twenty-five potential participants received a personalized invitation to complete the questionnaire using the Qualtrics mailing feature. Two reminders were sent in an effort to increase the response rate. There were 8 respondents from County A, 6 respondents from County B, and 5 respondents from County C for a total of 19 respondents, a response rate of 76%. To estimate non-response bias, early respondents were compared to late respondents as suggested by Lindner, Murphy, and Briers (2001). Results of an independent samples *t*-test indicated there was no significant difference in responses to each of the four sections between early and late respondents.

Data analysis used descriptive statistics. The calculation of means for ordinal data is controversial, however Norman (2010) stated if the ordinal values are reasonably distributed, then inferences can be made about means. We found the use of means to be most effective for comparing responses across counties, given the differing numbers of faculty and staff in each county Extension office. Individual county means and standard deviations were reported, as opposed to statistics for the [urban] area overall, because the tripartite funding structure of Extension means significant differences in system resources can exist between counties. The means for each item were interpreted as follows: 1.00 – 1.49 = *very low priority*, 1.50 – 2.49 = *somewhat low priority*, 2.50 – 3.49 = *moderate priority*, 3.50 – 4.49 = *somewhat high priority*, and 4.50 – 5.0 = *very high priority*.

An *ex post facto* analysis of reliability was conducted for the Resources, Partnership, and Implementation Framework constructs within the instrument; the Implementation Framework was excluded due to only having two items. The Cronbach's alpha levels were .85 for the Implementation Framework and .86 for both the Resources and Partnership Frameworks. Reliability levels were considered acceptable.

## Findings

The findings are divided into four sections corresponding to the Urban Extension Strategic Plan: Institutional Framework, Extension Resources, Partnership Framework, and Implementation Framework.

### Institutional Framework

Table 1 displays the individual county means for items within the Institutional Framework. All counties perceived developing guidelines to addressing reporting of collective impact efforts as a *somewhat high priority*. However, obtaining financial support from the University of Florida (UF) to support Extension in departments outside of the Institute of Food and Agricultural Sciences (IFAS) was perceived to be a *moderate priority* for County A and County B respondents, but a *somewhat high priority* for County C respondents.

Table 1

*Highest Priorities within the Institutional Framework.*

Priority	<i>M (SD)</i>		
	A	B	C
Develop guidelines to address reporting of collective impact efforts (e.g. facilitation of collaborative projects)	3.88 (1.2)	4.20 (.84)	4.33 (.52)
Obtain financial support from UF to support Extension in departments outside of IFAS	2.75 (1.2)	3.40 (1.1)	3.83 (.75)

*Note.* 1 = *Very low priority*; 2 = *Somewhat low priority*; 3 = *Moderate priority*, 4 = *Somewhat high priority*, 5 = *Very high priority*.

**Resources Framework**

Considerable variance was observed in terms of what county faculty and staff viewed as priorities within the Extension Resources section, which is likely a direct result of the difference in each county's assets (e.g. staffing, office location, funding). However, all counties uniformly agreed that the highest priority needs of the whole Urban Extension Strategic Plan resided within the Extension Resources Framework. Table 2 displays the means of the highest priorities for each county within the Resources Framework.

County A respondents rated two items as *very high priorities*: (a) establish new relationships with community locations where Extension programs can be provided, and (b) develop an external communications plan to give [State] Extension a recognized presence among urban audiences. County B respondents rated three items as *very high priorities*: (a) increase county funding for Extension, (b) obtain funding to hire additional programmatic support staff, and (c) obtain funding to hire additional administrative support staff. There was 100% agreement of County B respondents that additional county funding was a *very high priority*; this is the only item out of the whole questionnaire which had a mean of 5.00. County C respondents rated three items as *very high priorities*: (a) obtain funding to hire additional programmatic support staff, (b) develop an external communications plan to give UF/IFAS Extension a recognized presence among urban audiences, and (c) obtain funding to hire additional administrative support staff.

Table 2

*Highest Priorities within the Extension Resources Framework*

Priority	<i>M (SD)</i>		
	A	B	C
Develop an external communications plan to give UF/IFAS Extension a recognized presence among urban audiences	4.50 (.53)	4.20 (.84)	4.50 (.84)
Obtain funding to hire additional programmatic support staff	3.75 (1.4)	4.80 (.45)	4.83 (.41)
Establish new relationships with community locations (e.g. businesses or organizations) where Extension programs can be provided.	4.63 (.52)	3.80 (.84)	4.17 (.75)
Obtain funding to hire additional administrative support staff	3.63 (1.1)	4.60 (.55)	4.50 (.83)
Increase county funding for Extension	3.38 (.52)	5.00 (.00)	4.17 (.98)
Simplify branding for county-level Extension	2.88 (1.5)	4.40 (.55)	3.00 (1.7)
Relocate county offices to more accessible locations	2.13 (1.6)	4.40 (.89)	3.00 (.89)

*Note.* 1 = *Very low priority*; 2 = *Somewhat low priority*; 3 = *Moderate priority*, 4 = *Somewhat high priority*, 5 = *Very high priority*.

**Partnerships Framework**

None of the Partnership Essential Elements were considered *very high priorities* for attention within the next 12 months; most were rated as *somewhat high priorities*. Table 3 displays the means of the three highest priorities for each county within the Partnership Framework, as well as the overall Tampa Bay area. Counties tended to have consistent views of the degree to which the Partnership Essential Elements were priorities. County A and County B chose identifying new partners within local urban communities for cooperation on projects and programming aligned with urban needs as their highest priority for the next 12 months. The highest rated priority for County C was to create a strategy to identify and develop statewide partnerships with Florida's K-12 institutions.

Table 3

*Highest Priorities within the Partnership Framework*

Priority	<i>M (SD)</i>		
	A	B	C
Identify new partners within local urban communities for cooperation on projects and programming aligned with urban needs	4.13 (.83)	4.00 (.70)	4.00 (.63)
Create a strategy to identify and develop statewide partnerships with [State's] K-12 institutions	3.75 (1.3)	3.80 (1.3)	4.17 (.75)
Create a strategy for communicating the value of Urban Extension programming to nonurban stakeholders	3.88 (1.4)	4.00 (1.0)	3.83 (1.5)
Develop guidelines to address reporting of cooperative efforts with NGOs	3.50 (.76)	4.00 (.71)	3.50 (1.2)
Acquire sponsors who are engaged to support Urban Extension initiatives to address regional needs	2.88 (1.2)	3.60 (.89)	4.00 (.63)

*Note.* 1 = *Very low priority*; 2 = *Somewhat low priority*; 3 = *Moderate priority*, 4 = *Somewhat high priority*, 5 = *Very high priority*.

**Implementation Framework**

The following factors are related to the Implementation Framework of the Urban Extension Strategic Plan. Table 4 displays the means of the highest priorities for each county. As was observed for the Institutional and Partnership Frameworks, respondents tended to have consistent viewpoints across counties and there were no Essential Elements perceived as *very high priorities* within the Implementation Framework.

County A respondents perceived four Essential Elements to be *somewhat high priorities*: (a) conduct educational needs assessments in cooperation with local partners; (b) develop new standards to evaluate activities for efficiency and effectiveness in addressing urban needs; (c) county faculty receive support from UF to provide consulting, project design, and management service to local governments; and (d) increase number of coordinated statewide web-based education programs tailored for urban audiences. County B respondents perceived two Essential Elements to be *somewhat high priorities*: (a) county faculty receive support from UF to provide consulting, project design, and management service to local governments; and (b) increase number of coordinated statewide web-based education programs tailored for urban audiences. County C respondents perceived four Essential Elements to be *somewhat high priorities*: (a) increase number of coordinated statewide web-based education programs tailored for urban audiences; (b) conduct educational needs assessments in cooperation with local partners, (c) revise reporting templates to include a section on consulting, project design, and management service to local governments; and (d) use logic models throughout the planning, implementation, and evaluation phases for all urban projects.



Table 4

*Highest Priorities within the Implementation Framework*

Priority	<i>M (SD)</i>		
	A	B	C
Increase number of coordinated statewide web-based education programs tailored for urban audiences	3.50 (1.1)	3.80 (.45)	4.17 (.75)
Conduct educational needs assessments in cooperation with local partners	3.88 (.83)	3.40 (1.1)	3.67 (1.2)
County faculty receive support from IFAS to provide consulting, project design, and management service to local governments	3.50 (1.2)	4.00 (1.0)	3.33 (1.2)
Develop new standards to evaluate activities for efficiency and effectiveness in addressing urban needs	3.75 (1.0)	3.20 (.84)	3.33 (1.2)
Revise reporting templates to include a section on consulting, project design, and management service to local governments	3.00 (1.2)	3.40 (.55)	3.50 (1.2)
Use logic models throughout the planning, implementation, and evaluation phases for all urban projects	2.88 (1.4)	2.80 (.45)	3.50 (1.4)

*Note.* 1 = *Very low priority*; 2 = *Somewhat low priority*; 3 = *Moderate priority*, 4 = *Somewhat high priority*, 5 = *Very high priority*.

### **Conclusions, Implications, & Recommendations**

The assessment of needs within the counties of the Tampa Bay area clearly highlights the importance of sufficient resources to support Extension efforts within the urban environment. Of the four frameworks examined, only the Resources Framework contained needs considered to be very high priorities in one or more counties. In particular, a strong desire was expressed to add capacity through the hiring of programmatic and administrative support staff, expand Extension's access to community locations to provide programming, and improve external communications to give UF/IFAS Extension a recognized presence among urban audiences. The needs of the Tampa Bay area counties are similar to challenges discussed by Stienbarger (2005), Borich (2001), and Harder et al. (2009). UF/IFAS Extension will need to acquire new resources or reallocate existing resources to better equip its agents to be successful serving urban clientele.

The repeated identification of the same needs in multiple studies implies the Extension system at large is dealing with fundamental systemic issues which challenge its ability to be successful in the urban environment. This is considerable cause for concern given the need for Extension to be fully engaged within the urban environment (Henning et al., 2014). It is reasonable to suggest candid state and national level conversations about the viability of the current tripartite model of Extension moving forward must occur amongst policymakers and key stakeholders. Although many counties have been and continue to be strong supporters of Extension, it may be more sustainable and effective to move towards adding major municipalities as a fourth partner in order to meet the needs of urban residents. Such a move would represent a new direction in Florida, which currently has only one agent partially funded by a municipality. Research regarding the feasibility and consequences of partnering with municipalities as a funding approach is recommended as a foundation from which UF/IFAS Extension can begin exploring the expansion of municipality-based agents and staff.

Witkin and Altschuld (1995) asserted the importance of assessing system resources as a mechanism for understanding an organization's ability to meet the needs of its service providers and service users. There are several recommendations for UF/IFAS Extension to implement to address the highest priorities identified in the Tampa Bay area survey. General trends were observed across the Tampa Bay area although differences in the severity of counties' needs did exist. The organization should develop new or optimize existing funding streams to prioritize hiring programmatic support staff and administrative support staff rather than hiring more agents; the most critical needs are program assistants, clerical support, IT support, and marketing support. New relationships with community locations where Extension programs can be provided should be established, prioritizing locations within densely populated areas of each county and located near public transportation to increase accessibility to urban audiences. Finally, UF/IFAS Extension should collaborate with its Communication Services division to develop awareness campaigns targeted specifically towards potential community partners and urban clientele within the Tampa Bay area. These steps would be instrumental in moving UF/IFAS Extension closer to its goal of serving all audiences effectively.

### References

- Borich, T. O. (2001). The Department of Housing and Urban Development and Cooperative Extension: A case for urban collaboration. *Journal of Extension*, 39(6). Retrieved from <https://www.joe.org/joe/2001december/a2.php>
- Boyle, P. G. (1981). *Planning better programs*. USA: McGraw-Hill, Inc.
- Burnes, B., & Cooke, B. (2013). Kurt Lewin's Field Theory: A review and re-evaluation. *International Journal of Management Reviews*, 15(4), 408-425. doi: 10.1111/j.1468-2370.2012.00348.x
- Extension Committee on Organization and Policy (ECOP). (2007). *Strategic opportunities for Cooperative Extension*. Washington, DC: National Association of State Universities and Land-Grant Colleges.
- Harder, A., Lamm, A., & Strong, R. (2009). An analysis of the priority needs of Cooperative Extension at the county level. *Journal of Agricultural Education*, 50(3), 11-21. doi: 10.5032/jae.2009.03011
- Henning, J., Buchholz, D., Steele, D., & Ramaswamy, S. (2014). Milestones and the future for Cooperative Extension. *Journal of Extension*, 52(6). Retrieved from <https://www.joe.org/joe/2014december/comm1.php>
- Kaufman, R. (1988). *Planned educational systems: A results-based approach*. Lancaster, PA: Technomic.
- Lewin, K. (1939). Field theory and experiment in social psychology. *American Journal of Sociology*, 44(6), 868-896. doi:10.1086/218177

- Lindner, J. R., Murphy, T. H., & Briers, G. E. (2001). Handling nonresponse in social science research. *Journal of Agricultural Education*, 42(4), 43-53.
- Murray, M. (2005). The late, great California Extension system: What went wrong? *Proceedings of the International Society for Horticultural Science, International Symposium on Horticultural Education, Extension, and Training*, 4, 277-284.
- Norman, G. (2010). Likert scales, levels of measurement and the “laws” of statistics. *Advances in Health Sciences Education*, 15(5), 625-632. doi: 10.1007/s10459-010-9222-y
- Peters, S. J. (2002). Rousing the people on the land: The roots of the educational organizing tradition in extension work. *Journal of Extension*, 40(3). Retrieved from <http://www.joe.org/joe/2002june/a1.php>
- Rasmussen, W. D. (1989). *Taking the university to the people: Seventy-five years of Cooperative Extension*. Ames, IA: Iowa State University Press.
- Ruemenapp, M. A. (2017). America’s changing urban landscape: Positioning extension for success. *Journal of Human Sciences and Extension*, 5(2), 6-21.
- [State] Department of Transportation. (2015). *[State] transportation trends and conditions*. Retrieved from [http://www.\[state\].gov/planning/trends/pg15.pdf](http://www.[state].gov/planning/trends/pg15.pdf)
- Stienbarger, D. M. (2005). The view from county partners: Extension in southwest Washington. *Journal of Extension*, 43(2). Retrieved from <https://www.joe.org/joe/2005april/a1.php>
- Webster, N., & Ingram, P. (2007). Exploring the challenges for extension educators working in urban communities. *Journal of Extension*, 45(3). Retrieved from <https://www.joe.org/joe/2007june/iw3.php>
- Weiner, B. (1972). *Theories of motivation: From mechanism to cognition*. Chicago: Rand McNally.
- Wheeler, L. (2008). Kurt Lewin. *Social and Personality Psychology Compass*, 2(4), 638-1650. doi: 10.1111/j.1751-9004.2008.00131.x
- Witkin, B. R., & Altschuld, J. W. (1995). *Planning and conducting needs assessments: A practical guide*. Thousand Oaks, CA: Sage.

# **Examining Rural Community Planning: A Community Viability Indicator (CVI) Model**

Sarah A. Bush, Virginia Tech  
Rick Rudd, Virginia Tech

## **Abstract**

Community development initiatives must drive change to ensure fading rural municipalities are able to thrive and become viable communities. The community viability indicator (CVI) model, which includes community vision, sustainable infrastructure, capable leaders, and community sentiment as intertwined constructs, provides a basis for examining community development to increase overall community viability. A case study utilizing a concurrent, sequential, multi-phase mixed methods document analysis was conducted to examine four town development plans in comparison with the regional plan. Economic opportunities with a focus on historical, cultural, and tourism opportunities, partnerships, and citizen input emerged as themes within this case study. The regional plan yielded higher inclusion of CVI constructs. Community developers are including CVI constructs within their plans, but could still benefit from utilizing the CVI model in the planning process to incorporate the constructs and increase community viability.

## **Introduction**

Rural communities today are facing a multitude of economic and ecological hardships. Within the United States, rural counties represent 85% of persistent-poverty (USDA Rural Development, 2016). Community development initiatives, which promote overall community viability, are essential for driving change and ensuring fading communities thrive. Community development occurs when individuals work collaboratively in productive and non-exploitative ways to improve collective conditions for all individuals (Blackshaw, 2010). A viable community is sustainable, resilient, and provides inhabitants with sources of income and meaningful lives (Aarsaether, Riabova, & Barerenholdt, 2004).

Many rural communities have internal and external resources and assets available to drive change and increase societal capacity (Magis, 2010). Within community development, leaders should engage community members within the examination of motivation, enthusiasm, attitudes, informal leadership, needs, access, and relationships (Cavaye, 2001). The Community Viability Indicator (CVI) model provides a framework for considering community resources and initiatives through the intertwined constructs of community sentiment, capable leaders, community vision, and sustainable infrastructure (Hogg et al., 2016).

Through a CVI lens, a community's successes and failures can often be attributed to a lack in one or more of the constructs (Hogg et al., 2016). For instance, the implementation of a community vision is greatly impacted by a lack of community sentiment and investment by community members (Wang & Pfister, 2008). Capable leaders are required to ensure the community vision is shared by and with local residents. When creating community development plans, leaders, community members, and Extension personnel can use the CVI model to

understand the connectivity within their community and indicators of potential assets and barriers (Hogg et al., 2016).

Hogg et al. (2016) posit communities can benefit from using the CVI model to consider micro- and macro-level issues within the community development planning process. Within the state of Virginia, it is required for local planning commissions to develop and periodically update a comprehensive plan (Commonwealth of Virginia, 2017). These plans require assessment and studies to predict probable outcomes with existing conditions and current trends within the community. According to the Code of Virginia (Commonwealth of Virginia, 2017):

The comprehensive plan shall be made with the purpose of guiding and accomplishing a coordinated, adjusted and harmonious development of the territory which will, in accordance with present and probable future needs and resources, best promote the health, safety, morals, order, convenience, prosperity and general welfare of the inhabitants, including the elderly and persons with disabilities (para 2).

These comprehensive plans provide an avenue for exploring how constructs of the CVI model are already incorporated within the community planning process through preconstructed documents. With this insight, universities, Extension personnel, and agricultural educators will be better situated to connect the usage of the model with community partners. Therefore, this case study sought to examine town comprehensive plans within southwestern Virginia for connections to the CVI model.

### **Community Viability Indicator (CVI) Model**

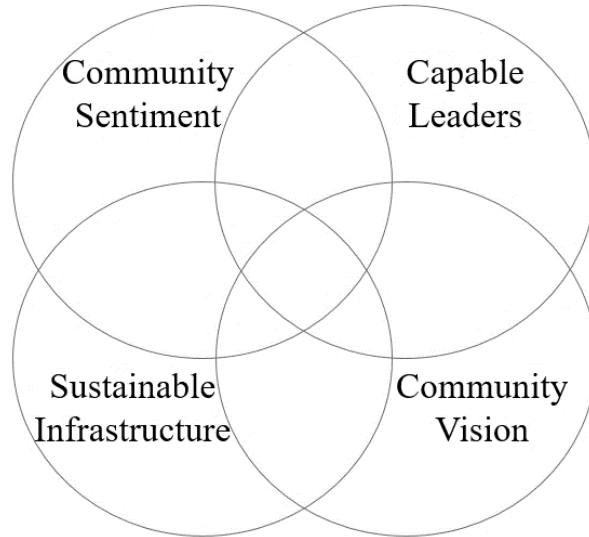

*Figure 1.* Community Viability Indicator (CVI) Model developed by Hogg et al. (2016)

The CVI model is a conceptual framework that encompasses capacities and conditions for a viable community (Figure 1). Within the CVI model, a viable community is one that is sustainable, resilient, and provide opportunities for citizens to lead meaningful lives (Hogg et al., 2016). Under this definition, sustainability represents social, economic, environmental, and institutional properties as an interconnected principle (Valentin & Spangenberg, 2000).

Sustainable communities are those who have longevity within their community assets and are able to adapt and change over time for continuous growth. Resilient communities thrive in the face of unexpected change, unpredictability, and times of uncertainty (Magis, 2010). Additionally, community members must be able to see their own futures within the community. Through an extensive literature review with a theoretical foundation based on diffusion of innovations theory, psychological sense of community theory, and the community capitals framework (Flora, Flora, & Gasteyer, 2015; McMillan & Chavis, 1986; Rogers, 2003), capable leaders, community sentiment, sustainable infrastructure, and community vision emerged as interconnected constructs that predict community viability.

## **Theoretical Framework**

Diffusion of innovations theory, psychological sense of community theory, and the community capitals framework serve as a theoretical basis for the CVI model. Diffusion of innovations theory provides insight on the paradox of social change (Rogers, 2003). Communities must be sustainable and resilient to be viable. In order to be viable, it is essential for communities to be open to and respond to change by accepting innovation initiatives. However, these initiatives must be attentive to community members' sense of community (McMillan & Chavis, 1986). This involves assessing membership, influence, integration, and fulfillment of needs for communities and their members. Community capitals framework provides a basis for understanding attributes, which contribute to community outcomes (Flora & Flora, 2008). Community capitals provide a foundation for community development enterprises and contribute to considerations for bolstering viability.

## **Conceptual Framework**

Based on a theoretical framework and previous literature, Hogg et al. (2016) developed the CVI model to encapsulate essential components for viable communities. Community sentiment, capable leaders, sustainable infrastructure, and community vision emerged as indicators for conditions and capacities for viable communities. These indicators are interrelated and intertwined. For example, community sentiment is increased when capable leaders engage community members within the development process of a community vision. Capable leaders identify and bolster sustainable infrastructure through the development and belief in a community vision. A community vision is generated through capable leaders and community sentiment to increase sustainable infrastructure. An enterprise to increase sustainable infrastructure entails capable leaders, a community vision with longevity, and community support and sentiment.

The constructs all relate and contribute to the theoretical foundation in varying ways. Diffusion of innovations theory provides a pathway for capable leaders to drive community sentiment to strengthen a community vision, which aims to increase sustainable infrastructure. Psychological sense of community theory provides insight on the role of community sentiment. Within this theory, positive community sentiment is the basis for capable leaders, likelihood of building a sustainable infrastructure, and the probability of community vision adoption. Community capitals have a bi-directional relationship with the CVI model and are the basis for

considering the indicators of community viability. Conversely, the CVI model also provides a conceptual model for examining capitals, assets, and attributes.

**Community vision.** Herbert-Chesire and Higgins (2004) postulated a community vision as “the key to improving the sustainability of disadvantaged regions and providing local people with the capacities to respond positively to change” (p. 289). Globalization challenges many rural communities to reexamine their community’s developmental trajectory and consider how change efforts may benefit their community’s growth and sustainability. Successful communities embrace change and are consistently implementing new innovations. To create a strong community vision, historical successes and failures must be examined to ensure community change is situated towards clear goals for thriving (Skerratt, 2013).

Rural communities must implement strategic thinking to vision for long-term planning efforts, which capitalize on community strengths and assets. Agritourism and historic perseveration initiatives are just two examples of ways rural communities utilized community visioning to increase local community viability (Wang & Pfister, 2008). A community’s vision requires capable leaders who believe and openly support the vision, community sentiment and support from members, and an investment in sustainable infrastructure (Hogg et al., 2016).

**Capable leaders.** Capable leaders are crucial to a community’s viability and are often directly related to the success, failure, and longevity of local initiatives (Beer, 2014). Institutional leaders, grassroots leaders, and the power elite all play distinct roles as capable leaders, and are the primary groups associated with decision-making and community action processes (O’Brien, Hassinger, Brown, & Pinkerton, 1991; Poplin, 1972). Institutional leaders are often appointed and have the role of representing the community through articulation of a clear vision, support for all community members, and providing an open climate for community member participation in community-based issue discussion (O’Brien, Raedeke, & Hassinger, 1998). Grassroots or opinion leaders do not always have formal authority, but often challenge the status quo and represent a voice, which other citizens acknowledge (Kezar & Gehrke, 2014).

These individuals engage within the community through local organizations and serve as indicators for community support of initiatives and reexamination of proposed goals. Finally, the power elite are those with the highest wealth, economic power, and/or personal influence (Poplin, 1972). The power elite have wide based networks and resources that provide assets for community collaboration (Beer, 2014). For these groups to work collaboratively, communities must acknowledge the importance of dispersion of power and leadership through community participation (Hogg et al., 2016). Capable leaders provide a voice for all community members to ensure that problem-solving efforts drive cohesion within the community.

**Community sentiment.** Community pride, engagement, heritage, culture, and values all impact overall community sentiment. Community sentiment emerges organically through community members’ ties and personal interactions within their communities (Hogg et al., 2016). This construct determines culture, values, and dynamics within individuals and requires a bi-directional relationship between the individual and their community (Lysgård, 2016). Within these relations, each individual plays a role within their community and their community provides services to the individual.

A shared community identity arises when community members feel a strong bond to their community and fully understand how they fit into the schema (Blackshaw, 2010; Emery, Fey, & Flora, 2006). Shared community identity and sentiment are not created, but emerge organically. However, efforts driven on community tradition, heritage, and multi-generational memories can increase enthusiasm within communities and ultimately lead to a community where residents feel more invested (Lysgård, 2016, Wall, 1999). The key to these endeavors is a participatory nature and relevance to community members (Deweese-Boyd, 2005; Glenzer, Peterson, & Roncoli, 2011). Community sentiment has the capacity to drive initiative, indicate capable leaders, and bolster infrastructure development through community engagement and support.

**Sustainable infrastructure.** Within the CVI model, sustainable infrastructure is the most tangible construct. When considering investment initiatives, viable communities develop structures, which last over time, and have minimal ecological impact (Parrish & Chester, 2014). Additionally, accessibility, safety, and inclusivity must all be considered to ensure infrastructure enables the creation of for social and cultural capital (Cabrera & Najarian, 2015). For instance, sidewalks, trails, downtown shopping areas, and walkable spaces all encourage community engagement (Leyden, 2003). Sustainable infrastructure also encompasses social infrastructure including: social services, healthcare, food access, and social stability. Both physical and social infrastructure act as the building blocks for further community development. Communities require sustainable infrastructure to drive economic stability and growth.

**Central themes.** Sustainable infrastructure, capable leaders, community vision, and community sentiment are interconnected and overlapping indicators of community viability. From a sociological perspective, it would be rare for one construct exist without the influence of another. Power, resilience, sustainability, and the opportunity to lead a meaningful life serve as the items, which intersect in the middle of the indicators. Power is an undercurrent to all aspects of a community impacting change efforts, assets, and community attributes (Ricketts & Place, 2009). Communities must be sustainable and resilient in all indicators of the CVI model to be a true viable community. Additionally, improved well-being of all community members must be central to all concepts of community viability. Communities must keep in mind the central themes, while examining CVI components.

### **Purpose and Research Questions**

The purpose of this case study was to explore if comprehensive plans of southwestern Virginia already incorporate components of the CVI model. This research aligns with research priority 6 of the American Association for Agricultural Education National Research Agenda, *Vibrant, Resilient Communities* (Graham, Arnold, & Jayaratne, 2016) by providing a model for examining indicators of community viability and increasing capacity within rural communities. We used a mixed method, document analysis design to explore the following questions:

RQ 1: Do comprehensive plans of southwestern Virginia communities include any constructs of the CVI model?

RQ 2: Within comprehensive plans of southwestern Virginia communities how are components of the CVI model incorporated?



RQ 3: What are the similarities and differences between a regional comprehensive plan and the comprehensive plans of communities within the region?

### Methodology

We completed this case study utilizing a concurrent, sequential, multi-phase mixed methods document analysis with a qualitative priority. The process of document analysis includes finding, selecting, appraising, and synthesizing data from the selected documents (Bowen, 2009). We selected a sample of comprehensive plans and selected a sample of town comprehensive plans based on the following criteria: population density, publication year, geographic location, and availability of a comprehensive plan. We anonymized the plans. We collected data collected concurrently and incorporated inductive and deductive analysis techniques. Table 1 includes the research design, which incorporated a sequential approach to qualitative analysis with both pre-set and emergent thematic coding procedures. We employed an inclusion rubric developed prior to data analysis for qualitative analysis. We chose a mixed method analysis design to capitalize on each individual method and provide a robust analytical design (Curry, Nembhard, & Bradley, 2009).

Table 1

*Research Design: Research Approach, Analysis, and Outputs for Each Research Question*

Research Question	Approach	Analysis and Outputs
RQ1: Do comprehensive plans of southwestern Virginia communities include any constructs of the CVI model?	Qualitative	We employed thematic coding for statements referring to any construct within the CVI model
RQ2: Within comprehensive plans of southwestern Virginia communities how are components of the CVI model incorporated?	Mixing	We coded articles with pre-set codes for each priority and association to each CVI construct. We used an inclusion rubric to score and quantize data. We examined previous thematic codes for each CVI construct priority.
RQ3: What are the similarities and differences between a regional comprehensive plan and the comprehensive plans of communities within the region?	Mixing	We examined scores on the rubric and thematic codes for each construct in comparison to the regional plan

The data collection process began with attainment of a regional development plan. We chose the specific region based on the researchers' knowledge of current community viability initiatives within the geographic area. Next, we attained all comprehensive plans from individual locales produced since 2010 with a population of less than 10,000. We excluded locales with county rather than individual town plans from the sample. The population yielded 10 potential locales for the sample. Out of the 10 locales, we excluded five based on population and one because it was a county wide plan. From the search, we attained and selected four

comprehensive plans for document analysis. We removed all identifying information from the documents for analysis.

We performed an iterative process, which combined content and thematic analysis, through superficial examination, thorough examination, and interpretation (Bowen, 2009). The content analysis began by reading each document and extracting relevant passages to the CVI model (Corbin & Strauss, 2008). This superficial examination allowed the researchers to separate any passage that was pertinent to the study and could be associated with a CVI construct. To answer the first research question, we open-coded the extracted passages with analytical codes (Corbin & Strauss, 1990, 1990). In phase one, we examined the analytical codes for patterns and emergent themes.

In phase two, we coded each extracted passage with pre-set codes relating to the constructs of the CVI model: community sentiment, capable leaders, community vision, and sustainable infrastructure. We determined each passage for priority to one of the four constructs. After being labeled as one of the four constructs, we then coded the passage for incorporation of other constructs. For instance, we found a passage to be primarily focused on community vision, but it mentioned capable leaders, we coded the passage with priority for community vision and incorporation of capable leaders. We then coded the purpose or vision statement for integration of CVI model constructs. We developed a rubric prior to coding to quantize the qualitative data (Pearce, 2012). We scored purpose/vision statement, community sentiment, capable leaders, community vision, and sustainable infrastructure individually on a scale of zero to four. The rubric, featured in Table 2, has a maximum total score of 20.

Table 2  
*CVI Model Construct Inclusion Rubric*

	0	1	2	3	4
Purpose/Vision Statement	Not Included	Includes one of the CVI model constructs	Includes two of the CVI model constructs	Includes three of the CVI model constructs	Includes all of the CVI model constructs
CVI Construct	Does not mention construct	Includes construct ten times or less	Includes construct more than ten times, but does not make a connection to other constructs	Includes construct more than ten times and makes a connection to at least one other construct	Includes construct more than ten times and makes a connection to all other constructs

*Note.* Each plan was scored individually for each CVI construct: community sentiment, sustainable infrastructure, community vision, and capable leaders. Scores were out of 20 points.

We scored each of the four town comprehensive plans and the regional plan on the rubric. We then examined the analytical codes in relation to the pre-set codes. We examined patterns within each construct for each plan for emergent themes. To answer question three, we compared the mean score of the town plan to the regional plan's score on the rubric for observable

differences. Finally, we compared the emergent themes identified for each construct within each town plan to the regional plan's emergent themes.

In qualitative analysis, it is important to acknowledge how our own biases, values, and background mold the findings in the study (Creswell, 2013). To increase authenticity, credibility, and trustworthiness (Creswell & Miller, 2000), we prepared the following reflexivity statement regarding our backgrounds and connections to the study:

Both researchers live within the selected geographic area and had prior knowledge of community viability initiatives. Additionally, both researchers collaborated with others in the development of the CVI model. To mitigate biases, we incorporated reflection and biases monitoring through the process to reduce impact on the study. This process included extracting passages associated with CVI constructs and multiple rounds of coding as separate processes.

## **Results**

To answer the first research question, we open-coded each of the town plans and examined patterns for emergent themes. Three themes, economic opportunities through community assets, citizen input, and partnerships, and two sub-themes, historical and cultural opportunities and tourism opportunities, emerged from the initial open coding process.

### **Economic Opportunities through Community Assets**

Throughout the plans, utilization of community assets to bolster economic opportunities was pervasive. These communities understood their assets and aimed to find ways to capitalize for continued economic development and employment opportunities. One community focused on their agricultural assets by purposing “the perpetuation of viable farms and the promotion of sound farming techniques are therefore important to the entire community” (Plan 2). This passage discussed the importance of upholding agricultural practices, which would be viable for generations and generate revenue to the community. Another discussed the importance of being selective with development “the town can benefit economically and socially by preserving open spaces and even profit by not developing on these sites” (Plan 4). This town recognized the importance of utilizing natural assets for community economic development. This theme included historical and cultural opportunities and tourism opportunities as sub-themes based upon their prevalence as economic opportunities for use of local assets.

**Historical and cultural opportunities.** These rural communities identified their rich histories and culture as opportunities for economic development and driving revenue to increase local infrastructure. Town plans frequently discussed preserving historic buildings as an opportunity to receive financial support to restore local landmarks and rebuild their downtown areas. Plan 1 included the following statement: “The Town should also continue to raise awareness of the availability of historic rehabilitation tax credits for qualifying structures in the Town’s residential historic districts.” Aside from preserving historical buildings, communities saw the potential benefits for capitalizing upon local culture for development of their downtown areas. “The Downtown area of [Town 2] is a cultural jewel that provides social and commercial capital for the Town, County, and region” (Plan 2). Plan 2 recognized the importance of a downtown area for not only economic development, but also for increasing social capital.

**Tourism opportunities.** “The Town recognizes the increasing importance of tourism to the local economy” (Plan 3). The community plans shared this view of tourism. Plan 3 also included this passage “by promoting the area’s river and mountain assets, the Town and its partners will help tourism make a growing contribution to the economy of the [Town 3] area.” This passage explicitly states how the town intends to use natural assets to increase tourism within the community. Similarly, plan 4 discussed ecological value in relation to tourism, “fish and wildlife are important resources to the [Town 4]. In addition to their ecological value, these resources help draw tourists and outdoor recreation enthusiasts to the area.” This community saw value in their recreational opportunities for tourism.

## **Citizen Input**

The documents included various different discussions related to citizen input. Some discussed the importance of engaging citizens with community planning and development processes. For example, “ensure the sustainability of the rural life and local heritage through citizen input and involvement” (Plan 2). Here the town recognizes the importance of buy-in from community members. Others mentioned goals and objectives driven from community member surveys and evaluations. Plan 3 states “the people [Town 3] recognize that growth and economic development can improve the quality of life.” This town incorporated this passage from community input gathered prior to development of the plan. Although the type of citizen input varied, all plans discussed the importance of citizen input in development processes.

## **Partnerships**

The plans discussed the importance of partnerships for community success. Partnerships ranged from local to regional to statewide to global. However, the most common discussion of partnerships was around the importance of maintaining local partnerships for the benefit of citizen engagement. One community discussed the importance of working collaboratively on community activities. “A goal for the Town is to work towards better communication with these various organizations and increased cooperation and coordination of activities” (Plan 3). Another saw the goal of partnerships to increase community investment. “Work with partner organizations, businesses, and citizens to maintain and improve an atmosphere that encourages investment in the community” (Plan 1). Within these two examples and throughout the plans, partnerships were viewed as ways to add benefit to the community by increasing opportunities for growth and an overall sense of belonging for citizens.

After examining emergent themes, each extracted passage underwent a second round of coding with pre-set codes for priority to one of the four CVI model constructs: community vision, capable leaders, community sentiment, and sustainable infrastructure. If the passage had a connection to more than one construct, we sub-coded the additional constructs. We determined priority based on the construct, which was dominant in the passage. We then used the codes to quantize the data through an inclusion rubric. Scores for each construct and total scores out of 20 are included in Table 3. The regional plan had the highest score of 18 with plan 4 scoring the lowest at 13. Community vision and community sentiment had the highest mean score of 3.75. Purpose ( $M=2.50$ ) and capable leaders ( $M=2.25$ ) yielded the lowest means, respectively. The

regional plan received a 4 for capable leaders. The regional plan generated higher scores on all constructs except for sustainable infrastructure.

Table 3

*Town and Regional Scores for Each Category, Total Scores, Means of Town Scores*

Plan	Purpose	Community Vision	Capable Leaders	Community Sentiment	Sustainable Infrastructure	Total
1	3	4	3	4	3	17
2	3	4	1	4	3	15
3	2	4	4	3	3	16
4	2	3	1	4	3	13
	<u>M</u>	<u>M</u>	<u>M</u>	<u>M</u>	<u>M</u>	<u>M</u>
	2.50	3.75	2.25	3.75	3.00	15.25
Regional	3	4	4	4	3	18

*Note:* Mean scores were determined for the town scores to be compared to the regional score.

To compare the individual town plans with the regional plan, we compared the open codes from phase one to the codes from round two relating to the CVI model. We then identified emergent thematic patterns for each construct for each individual plan (Table 4). Emergent thematic patterns for each construct yielded some notable differences between the regional plan and individual community plans. Overall, the regional plan had a higher focus on people. For example, within the plan it stated:

The [Region] sees its people as its greatest resource for economic sustainability. We recognize that in order for our area to be prosperous, our people must have the tools, resources, and education necessary to reach their full potential as citizens, workers and leaders.

This passage captures the investment the region has in the inhabitants and developing their skills for community viability. This was prevalent throughout passages coded with a community vision priority with community engagement and partnerships being common themes. The four town plans discussed leadership in terms of identifying leaders, explaining their role in partnerships and utilizing the views of citizens for plan implementation. Plan 2 did discuss the importance of utilizing leadership to build a sense of community. However, the regional plan dedicated a large section of the plan to discussing citizen advancement and workforce skills and programs for both adults and youth. This passage represents an overview of the section, “The Leadership category highlights opportunities in the [Region] for promoting and sustaining leadership development and engagement in our local and regional community.”

The regional plan also varied in the discussion of sustainable infrastructure with a higher focus on education and human services for the betterment of local citizens to promote economic success. The plan noted a goal “to train and re-train workers for higher skills and productivity in the 21st Century economy.” Additionally, the plan then discussed skill advancement as a way to increase the economic opportunities for individuals and the community as included in this goal “to enhance and link the region's labor skills and technology advantages to improve wage levels.” Community sentiment had similar patterns in themes. The following passage includes an exemplar understanding of community sentiment taken from the regional plan: “The Natural and

Cultural projects represent the importance our citizen's place on the often intangible aspects of quality of life that can make a place one that people are proud to call home.”

Table 4

*Emergent Thematic Patterns for each Construct*

Plan	Community Vision	Capable Leaders	Community Sentiment	Sustainable Infrastructure
1	Increase sense of community, Economic opportunities, Community Assets	Identified institutional leaders, Partnerships, role of citizens views	Community organizing, Citizen investment, tourism, and Historic/Cultural Opportunities	Community assets, Community opportunities, Partnerships, Community issues
2	Opportunities, Historical/cultural preservation, Citizen views	Institutional leaders identified, Sense of community	Citizen Engagement, Historic/Cultural, Agriculture	Community opportunities, Community assets, Citizen views, Partnerships
3	Citizen investment, Community opportunities, Community assets	Institutional leaders identified, Partnership, the role of citizen views	Citizen Engagement, Historic/Cultural Opportunities, Tourism	Community assets, Economic opportunities, Partnerships, Community issues
4	Economic opportunities, Citizen views, community opportunities with community assets	Partnerships and the role of citizen views	Sense of belonging, Citizen Views, Historical/cultural preservation	Economic opportunities, Community assets, Partnerships
Regional	Citizen engagement, Economic opportunities, Partnerships	Citizen advancement, Workforce skills and programs	Historical/Cultural opportunities, Tourism, Citizen engagement	Economic opportunities, Education, Human services

*Note.* Thematic patterns were derived from sorting CVI model construct priority and the codes from the first phase open-coding process.

**Conclusions, Implications, and Recommendations**

Communities could benefit from the usage of the CVI model with consideration to micro- and macro-level issues within the community development process (Hogg et al., 2016). Within

this exploratory case study, we uncovered the constructs from the CVI model throughout community development plans and a regional plan. The town plans discussed community sentiment, capable leaders, community vision, and sustainable infrastructure through the emergent themes: economic opportunities, partnerships, and citizen input. The town plans included initiatives for tourism, historic preservation, and cultural initiatives to drive economic development. Within the CVI model, these initiatives are suggested for inclusion within a community vision to drive community sentiment and increase infrastructure (Wang & Pfister, 2008).

The results indicate components of the CVI model are evident within community development plans. Citizen input is postulated to increase community sentiment and investment of community members (Hogg et al., 2016). Partnerships are incorporated as opportunities for the power elite and capable leaders to increase networks and community collaboration for development of a sustainable infrastructure. Although citizen input and partnerships were emergent themes these concepts were not readily discussed as a part of capable leadership. Developing capable leaders was a primary focus of the regional plan. However, the town plans primarily discussed leadership in terms of identifying leaders, explaining their role in partnerships, and utilizing the views of citizens for plan implementation. These rural communities should continue to explore the importance of building leaders.

Universities, Extension personnel, and agricultural educators have a critical role in increasing resiliency and building capacity through community outreach programs (Graham et al. 2016). The CVI model provides a framework for increasing knowledge and understanding of the mechanics of one's community to increase rural community viability. Outreach programs, which are developed with the model in mind, stand to further community development initiatives and drive community change.

### **Recommendations**

There are clear ties between the CVI model and existing plans. Education on the framework and a purposive effort to plan around the framework may lead communities to more robust planning and eventually, more resilient communities. We recommend that Virginia Cooperative Extension utilize this framework in community viability efforts. This framework stands to provide a different avenue for communities to consider how each portion of their community development plan is impacted through multiple different constructs.

We found less than optimal ties between the regional and local plans, we recommend a concerted effort for regional and local leaders to work together on planning efforts. Rural leaders and communities need to exploit all resources available to increase viability. The regional plan efforts provide further resources for local communities. Additionally, communities within the area will require variety of tourism initiatives to not overrun their geographic area with the same amenities. By working together regionally, communities can find diverse ways to use historical and cultural opportunities, which differ from neighboring locales.

While the existence of the components of the framework are evident there is no evidence of the effectiveness of the components on community viability. We recommend research be conducted using the CVI model to frame community planning. The research should be longitudinal with measures of viability as explained by capable leaders, sustainable infrastructure, community vision, and community sentiment. Citizen input and partnerships with universities, Extension personnel, and agricultural educators will be essential in this endeavor.

## References

- Aarsaether, N., Riabova, L., & Baerenholdt, J. O. (2004). Community viability. *Arctic Human Development Report*, 139-153.
- Hogg, D., Bush, S. A., Rudd, R., & Seibel, M. (2016). *Community viability indicator (CVI) model for rural communities*. Unpublished manuscript. Department of Agricultural, Leadership, and Community Education, Virginia Polytechnic and State University, Blacksburg, VA.
- Beer, A. (2014). Leadership and the governance of rural communities. *Journal of Rural Studies*, 34, 254-262. doi:10.1016/j.rurstud.2014.01.007
- Blackshaw, T. (2010). *Key Concepts in Community Studies*. Thousand Oaks, CA, Sage Publications.
- Bowen, G. A. (2009). Document analysis as a qualitative research method. *Qualitative Research Journal*, 9(2), 27-40. doi:10.4135/9781452270043
- Cabrera, J. F., & Najarian, J. C. (2015). How the built environment shapes spatial bridging ties and social capital. *Environment and Behavior*, 47(3), 239-267. doi:10.1177/0013916513500275
- Cavaye, J. (2001). Rural community development- New challenges and enduring dilemmas. *The Journal of Regional Analysis & Policy*, 31(2), 109-124.
- Commonwealth of Virginia. (2017). Code of Virginia. Retrieved from <https://law.lis.virginia.gov/vacode>
- Corbin, J., & Strauss, A. (1990). Grounded theory research: Procedures, canons and evaluative criteria. *Zeitschrift für Soziologie*, 19(6), 418-427.
- Corbin, J., & Strauss, A. (2008). *Basics of qualitative research: Techniques and procedures for developing grounded theory*. Los Angeles, CA: Sage Publications.
- Creswell, J. W. (2013). *Research design: Qualitative, quantitative, and mixed methods approach*. Los Angeles, CA: Sage Publications.



- Creswell, J. W., & Miller, D. L. (2000). Determining validity in qualitative inquiry. *Theory Into Practice*, 39(3), 124-130.
- Curry, L. A., Nembhard, I. M., & Bradley, E. H. (2009). Qualitative and mixed methods provide unique contributions to outcomes research. *Circulation*, 119(10), 1442-1452. doi: 10.1161/CIRCULATIONAHA>107.742775
- DeWeese-Boyd, M. (2005). Community versus development? Land use and development policy in Vermont as a tool toward community viability. *Community Development Journal*, 41(3), 334-351. doi:10.1093/cdj/bsi060
- Emery, M., Fey, S., & Flora, C.B. (2006). Using community capitals to build assets for positive community change. *Community Development Practice*, 13. Retrieved from <http://srdc.msstate.edu/fop/levelthree/trainarc/socialcapital/communitycapitalstodevelopasstsemeryfeyflora2006.pdf>
- Flora, C. B., Flora, J., L. (2008). *Community capitals*. Retrieved from <http://www.soc.iastate.edu/staff/cflora/ncrcrd/capitals.html>
- Flora, C. B., Flora, J. L., & Gasteyer, S. P. (2015). *Rural communities: Legacy and change* (5th ed.). Boulder, CO: Westview Press.
- Glenzer, K., Peterson, N., & Roncoli, C. (2011). Introduction to symposium on rethinking farmer participation in agricultural development: Development, participation, and ethnography of ambiguity. *Agriculture and Human Values*, 28(1), 97-98. doi:10.1007/s10460-010-9305-7
- Graham, D. L., Arnold, S., & Jayaratne, K. S. U. (2016). Research priority 6: Vibrant, resilient communities. In T. G. Roberts, A. Harder, & M. T. Brashears (Eds.), *American Association for Agricultural Education national research agenda: 2016-2020* (pp. 49-56). Gainesville, FL: Department of Agricultural Education and Communication.
- Herbert-Cheshire, L., & Higgins, V. (2004). From risky to responsible: Expert knowledge and the governing of community-led rural development. *Journal of Rural Studies*, 20(3), 289-302. doi:10.1016/j.rurstud.2003.10.006
- Kezar, A., & Gehrke, S. (2014). Grassroots leadership: Responding to declining shared governance in the neoliberal world. In Li, Q., & Gerstl-Pepin, C., *Survival of the fittest: The shifting contours of higher education in China and the United States* (pp. 101-117). Springer-Verlag Berlin Heidelberg.
- Leyden, K. M. (2003). Social capital and the built environment: The importance of walkable neighborhoods. *American Journal of Public Health*, 93(9), 1546-1551. doi:10.2105/AJPH.93.9.1546

- Lysgård, H. K. (2016). The 'actually existing' cultural policy and culture-led strategies of rural places and small towns. *Journal of Rural Studies*, *44*, 1-11. doi:10.1016/j.jrurstud.2015.12.014
- Magis, K. (2010). Community resilience: An indicator of social sustainability. *Society and Natural Resources*, *23*(5), 401-416. doi:10.1080/08941920903305674
- McMillan, D. W., & Chavis, D. M. (1986). Sense of community: A definition and theory. *Journal of Community Psychology*, *14*(1), 6-23. doi:10.1002/1520-6629(198601)14:1<6::AID-JCOP2290140103>3.0.CO;2-I
- Poplin, D. E. (1979). *Communities: A survey of theories and methods of research*. New York, NY: Macmillan Publishing Co, Inc.
- O'Brien, D. J., Hassinger, E. W., Brown, R. B., & Pinkerton, J. R. (1991). The social networks of leaders in more and less viable rural communities. *Rural Sociology*, *56*(4), 699-716. doi:10.1111/j.1549-0831.1991.tb00453.x
- O'Brien, D. J., Raedeke, A., & Hassinger, E. W. (1998). The social networks of leaders in more or less viable communities six years later: A research note. *Rural Sociology*, *63*(1), 109. doi:10.1111/j.1549-0831.1998.tb00667.x
- Parrish, K., & Chester, M. (2014). Life-cycle assessment for construction of sustainable infrastructure. *Practice Periodical on Structural Design and Construction*, *19*(1), 89-94. doi:10.1061/(ASCE)SC.1943-5576.0000187
- Pearce, L. D. (2012). Mixed methods inquiry in sociology. *American Behavioral Scientist*, *X*(XX), p. 1-20. doi: 10.1177/0002764211433798
- Ricketts, K. G., & Place, N. T. (2009). Making communities more viable: Four essential factors for successful community leadership. *Journal of Extension*, *47*(2), 1-4. Retrieved from: <https://www.joe.org/joe/2009april/iw2.php>
- Rogers, E. M. (2003). *Diffusion of innovations* (5th ed.). New York, NY: Free Press.
- Skerratt, S. (2013). Enhancing the analysis of rural community resilience: Evidence from community land ownership. *Journal of Rural Studies*, *31*, 36-46. doi:10.1016/j.jrurstud.2013.02.003
- Valentin, A., & Spangenberg, J. H. (2000). A guide to community sustainability indicators. *Environmental Impact Assessment Review*, *20*(3), 381-392. doi:10.1016/S0195-9255(00)00049-4
- USDA Rural Development. (2016). *USDA rural development: 2016 progress report*. Retrieved from <https://www.rd.usda.gov/files/USDARDProgressReport2016.pdf>

Wall, M. (1999). Factors in rural community survival: Review of insights from thriving small towns. *Great Plains Research*, 9(1), 115-135.

Wang, Y. A., & Pfister, R. E. (2008). Residents' attitudes toward tourism and perceived personal benefits in a rural community. *Journal of Travel Research*, 47(1), 84-93.  
doi:10.1177/0047287507312402

# **Good Agricultural Practices Training for Extension Educators and Produce Growers**

John C. Ricketts, Tennessee State University  
Agnes Kilonzo-Nthenge, Tennessee State University

## **Abstract**

The purpose of this project was to evaluate training to educate produce growers and Extension educators on Good Agricultural Practices (GAP) leading to produce safety. Prior to the training, farmers and Extension educators were aware, but not understanding of the necessary nature of written food safety plans and other GAP, but after the training they both reported understanding. Following the training, farmers indicated they were likely to implement written food safety plans, and correct procedures for water testing, soil amendments, washing produce, record keeping, container cleaning and produce spinning/drying. Before the training program, Extension educators were not comprehensively teaching GAP, but following the training they indicated they were likely or very likely to teach all GAP.

## **Introduction**

Outbreaks of food-borne illness linked to fruits and vegetables can put those who enjoy fresh produce at risk of getting sick. The number of documented infections associated with the consumption of fresh produce has increased in the United States (Erickson, 2012; Sivapalasingam, Friedman, Cohen, & Tauxe, 2004). Due to increasing outbreaks associated with fresh produce, the consumer is concerned about food quality and safety of fresh produce (Warriner, Huber, Namvar, Fan, & Dunfield, 2009). Food-borne illness is a significant public health burden that is preventable. Produce safety rules set by the Food Safety Modernization Act (FSMA) shift the focus from responding to contamination to preventing contamination in the nation's food supply (Food Safety Modernization Act, 2011). FSMA aims to improve the culture of food safety and enforces a culture change for most food systems. How do farmers and producers even become aware of changes in the food systems? As with many policies and technologies implemented in agriculture over the years, the Extension educator is a major part of the equation. Extension is positioned to influence changes in local food systems; therefore, educators must work with producers to co-discover new realities beneficial for both consumers and producers (Raison, 2010).

## **Theoretical and Conceptual Framework**

We combined aspects of Fishbein and Azjen (1980; 1975) Theory of Reasoned Action (TRA) and Zanna and Rempel's (1988) Conceptualization of Attitudes to form the theoretical framework. The TRA is a model that predicts human behavior (Fishbein & Azjen, 2010). According to TRA, attitudes and subjective norms determine behavioral intentions, and those intentions determine the ultimate behavioral outcomes, which, relative to our study, involve producers' implementing GAP prescribed by FSMA so that they remain compliant with efforts to provide a safe food supply. Zanna and Rempel's Conceptualization of Attitudes theory explains how attitude is developed from cognition (knowledge of GAP), affect (feelings and emotions related to GAP), and past behaviors. Figure 1 shows the conceptual model underlying our study; as designated by the stars on variables represented in the model, we designed our study to evaluate only cognition, past behaviors, and behavioral intention.

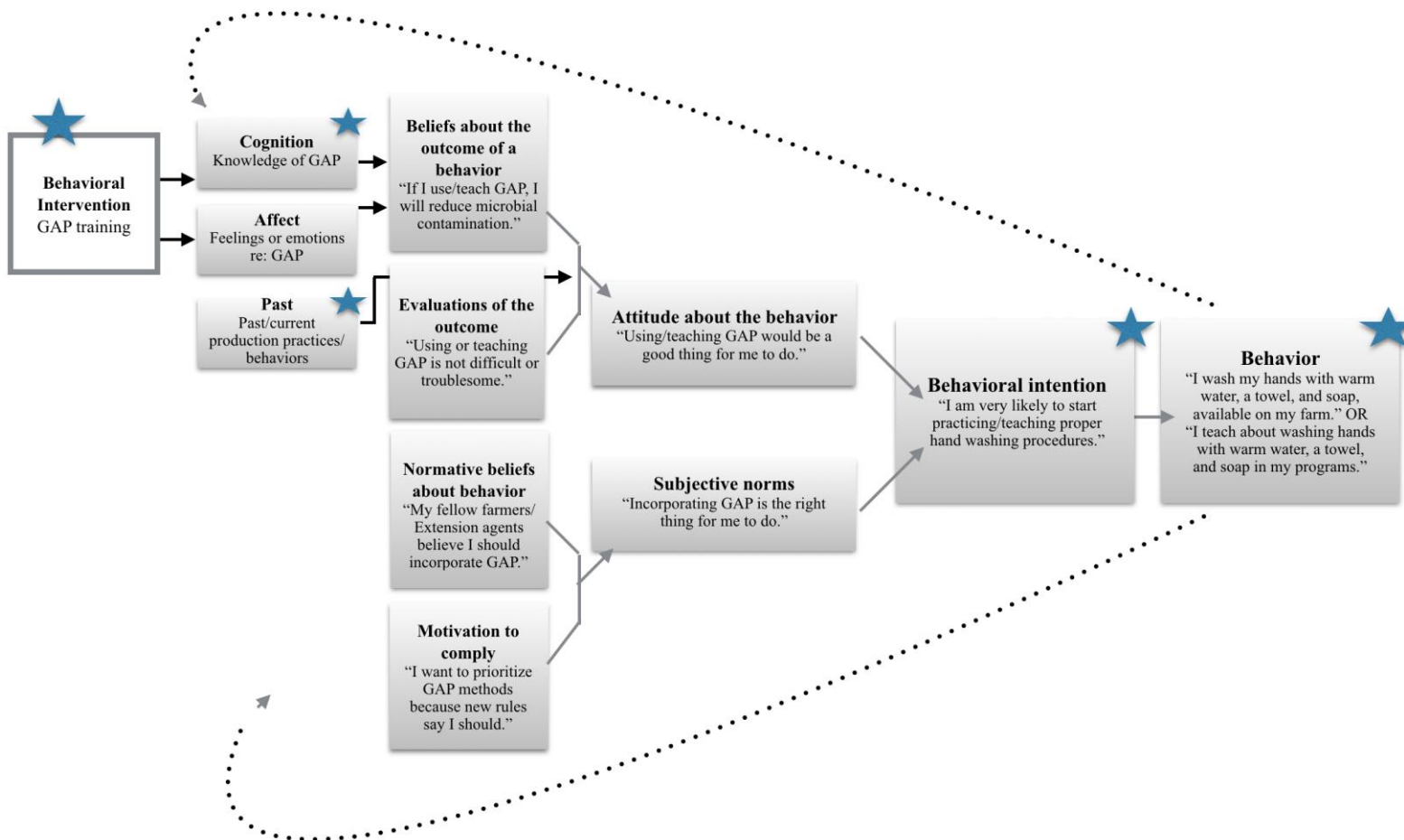

Figure 1. Conceptual Model of Good Agricultural Practices (GAP) Behavior Change for Producers and Extension Educators (Adapted from Belief, Attitude, Intention, and Behavior: An Introduction to Theory and Research (p. 16), by M. Fishbein & I. Ajzen, 1975, Reading, MA: Addison Wesley)

Behavioral intention is most predictive of behavior (Godin & Kok, 1995), but intention is related to attitudes that are affected by cognition/knowledge. The behavioral intervention of GAP training we delivered to producers and Extension educators was applied to attitudes and cognition predictors of attitudes in our model. Azjen (2011) espoused that applying a behavioral intervention to attitudes and their determinants (cognition/knowledge) is an effective method for creating behavior change.

In the American Association for Agricultural Education National Research Agenda (NRA) (Roberts, Harder, & Brashears, 2016), *Research Priority 2: New Technologies, Practices, and Products Adoption Decisions*, Lindner, Rodriguez, Strong, Jones, and Layfield (2016) make it clear that research on adoption and diffusion of new practices is an essential part of agricultural education. Our study addresses both of the NRA's research priority questions related to methods, models, and practices that lead to effective change and diffuse innovations.

### **Purpose and Objectives**

The purpose of our project and study was to effect change and diffuse farmer and Extension agent use of GAP in produce production. Specifically, we sought to educate and train small- and medium-scale produce growers and Extension educators on the practical applications of GAP, thereby fostering improvements in produce safety. The specific objectives of the study were as follows:

1. Describe farmers' current produce production practices.
2. Explain farmers' intentions regarding adopting GAP.
3. Determine Extension educators' current teaching practices regarding produce production.
4. Explain Extension educators' intentions regarding teaching GAP in produce production.
5. Identify changes in farmers' and educators' knowledge of overarching aspects of GAP as a result of the educational intervention (a GAP workshop).
6. Describe actual behavior change through follow-up visits to select participant farmers.

### **Procedures and Methods**

#### **Development of GAP Workshop and Associated Instruments**

Prior to developing the GAP workshop, we selected 12 progressive produce growers—four growers from each Tennessee region (East, Middle, and West)—to form a focus group. From the focus group data, we planned the content of the GAP workshop. Questionnaires linked to focus group data were developed for producers and Extension educators. The instrument addressed producers' existing production practices and their intentions regarding adopting GAP learned at the workshop. The educator instrument addressed educators' existing practices regarding the teaching of GAP content and their intentions regarding incorporating GAP information in their educational programs. Topics covered in the workshop (Table 1) were tied to rules for produce safety as stipulated in FSMA. Workshop presenters provided technical training intended to empower participants to meet the consumer demand for safe produce.

## Produce Grower and Train-the-Trainer GAP Workshop

Preventing microbial contamination requires widespread education; therefore, we invited Extension educators to participate in the workshop. Educated extension agents are in a position to teach many more producers about the FSMA standards and GAP than we could reach with one workshop. Four months after conducting the focus group research, we held a 2-day workshop for produce growers and educators (Day One) and Extension educators only (Day Two) at Tennessee State University. Table 1 lists the specific topics covered at the workshop.

Table 1

### *Topics taught During the Two-day Good Agricultural Practices Workshop*

Day	Topic
Day One (for Producers and Extension educators)	Food Safety Modernization Act
	Economic importance of food-borne illness
	Production issues related to water
	Production issues related to soils
	Production issues related to human health
	Production issues related to hygiene
	Testing of agricultural water
	Hand washing
	Harvest and postharvest handling issues
	Traceability, recall, and record keeping
	Food safety plans and how to write them
	Audits
	Day Two (for Extension educators only)
Introduction to GAP	
Production issues (human and animals)	
Production issues related to soil	
Production issues related to water	
Water quality testing	
Irrigation water directly applied	
Hand washing	
Traceability, recall, and record keeping	
Resources and activities	
Follow-up visits	

At the end of the workshop, the questionnaires we developed were administered to participants. Producers and educators answered yes or no to questions about whether they were engaging in or teaching specific GAP at the time of the workshop. To identify their intentions related to various GAP presented during the workshop, participants selected one of four possible responses on a summated rating scale: 1 (*very unlikely*), 2 (*unlikely*), 3 (*likely*), or 4 (*very likely*). The producer questionnaire asked about implementing the GAP, and the extension educator questionnaire asked about teaching the GAP in their educational programs. A panel of experts for face validity reviewed the instrument, but there were too few cases to report a measure of reliability.

We also implemented a retrospective “pre-post” model of survey research (Davis, 2003; Rohs, 1999) that involved a summated rating scale to determine changes in knowledge of seven overarching aspects of GAP as a result of the workshop. Growers and extension educators were asked to indicate what their levels of awareness of these aspects of GAP had been before the workshop and what their levels of awareness of the aspects were after the workshop. The response set of the scale was as follows: 1 = Not at all; 2= Maybe heard it before; 3= Some awareness & no understanding; 4=Aware & understood; and 5=Very aware & understood clearly.

### **Follow-Up Visits**

During a time period that was 4 months after the GAP workshop and six months into the growing season, extension educators and food safety consultants visited individual farms to determine whether a written food safety plan had been implemented, what GAP had been implemented, and specifically how GAP had been implemented.

### **Results**

The attendees of the workshop included 35 produce growers, 15 Extension educators, and 6 researchers. The majority of the respondents, 20 farmers and 10 Extension educators returned completed questionnaires.

### **Farmers’ Existing Practices and Intent to Make Changes**

Tables 2 and 3 show data related to farmers’ practices before participating in the workshop and intent to make GAP-related changes after the workshop. Farmers’ implementation of GAP prior to attending the workshop was wide ranging. For example, only 5% of respondents kept a written food safety plan, whereas 95% ensured that crop production areas and livestock production facilities were separated.

Table 2

*Percentages of Farmers Using GAP Prior to the GAP Workshop (n = 20)*

GAP	%
Have a written food safety plan	5
Spin/dry produce	15
Test water annually	30
Use gloves when handling produce	40
Use water/ice in direct contact with produce during harvest	40
Limit raw manure use to at least 2 weeks prior to planting and 120 days prior to harvest	45
Keep records for the farm	45
Make hand-washing facilities with warm water, soap, & towels available	55
Clean harvest/transport containers	65
Use cold water to wash produce	65
Avoid use of improper soil amendments (e.g., raw, partially treated, and treated manure)	30
Wash produce after picking	70
Wash hands at appropriate times (before/after eating, smoking, visiting restroom)	80
Separate crop production areas and livestock production facilities	95



Table 3

*Farmer Intent to Make Changes Related to GAP in Fresh Produce Production (n = 20)*

GAP	Likelihood of changing	
	<i>M</i>	<i>SD</i>
Test water appropriately	3.67	0.65
Implement a written food safety plan	3.41	0.80
Use proper soil amendments	3.33	0.98
Wash picked produce	3.23	1.09
Use raw manure properly	3.18	0.98
Keep records	3.07	1.07
Clean harvest containers	2.92	1.12
Spin/dry produce	2.79	1.12
Separate production areas and livestock facilities	2.50	2.12
Incorporate hand washing facilities	2.46	1.33
Wear gloves	2.36	1.08
Use appropriate water temperature	2.27	1.10
Properly use water/ice in direct contact with produce	2.00	0.89
Wash hands correctly	1.80	1.14

Note. 1 = Very Unlikely, 2 = Unlikely, 3 = Likely, 4 = Very Likely

Farmers were mixed as well with regard to their intent to make changes after participation in the workshop. Respondents were likely to test water appropriately, implement a food safety plan, use soil amendments, wash picked produce, use raw manure properly, keep records, clean harvest containers and spin/dry produce. However, they were unlikely to make changes related to separating livestock from produce, incorporating hand washing facilities, wearing gloves, using the appropriate water temperature and hand washing itself.

### **Extension educators' existing practices and intentions**

Tables 4 and 5 display data related to Extension educators' existing practices before participating in the workshop and intent to teach produce food safety after the workshop.

Table 4

*Extension Educators Teaching of Selected GAP Topics Prior to the GAP Workshop (n = 10)*

GAP Topic	Percentage (%)
Spinning/drying produce	0
Testing water	30
Washing produce after picking	30
Using water/ice in direct contact with produce	40
Keeping records	40
Managing crop production areas and livestock facilities	40
Using soil amendments	50
Using gloves while handling produce	50
Washing hands at appropriate times	50
Incorporating hand washing facilities	60

Cleaning harvest containers	60
Writing food safety plans	70

Extension educators in our study were likely or very likely to make teaching and curricular changes for all the GAP topic areas discussed in the Train-the-Trainer workshop (Table 5).

Table 5  
*Extension Educators' Intentions to Teach Produce Food Safety GAP (n = 10)*

	Likelihood of changing	
	<i>M</i>	<i>SD</i>
Keeping records	3.83	0.41
Washing hands	3.71	0.49
Using water/ice in direct contact with produce	3.71	0.49
Writing food safety plans	3.63	0.52
Applying raw manure properly	3.63	0.52
Wearing gloves	3.57	0.53
Using soil amendments	3.50	0.54
Incorporating hand washing facilities	3.50	0.84
Cleaning picked produce	3.38	0.74
Testing water	3.33	1.32
Spinning/drying produce	3.20	0.63
Cleaning containers	3.13	1.36
Separating crop production and livestock facilities	3.12	0.75

Note. 1 = Very Unlikely, 2 = Unlikely, 3 = Likely, 4 = Very Likely

### Knowledge of GAP Before and After GAP Training

Producers' and Extension educators' knowledge of seven aspects of GAP addressed by the content of the workshop significantly improved from before the workshop to after it (Table 6). Even though Extension educators were more informed than producers prior to workshops, their scores significantly improved as well. Changes in participants' knowledge of GAP were not only significant, but the changes had a large effect size for nearly all items.

Table 6  
*Knowledge of Overarching Aspects of GAP Before and After GAP Workshop*

Aspect of GAP	Producers (n = 20)					Extension Educators (n = 10)				
	Retro		Post		<i>d</i>	Retro		Post		<i>d</i>
	<i>M</i>	<i>SD</i>	<i>M</i>	<i>SD</i>		<i>M</i>	<i>SD</i>	<i>M</i>	<i>SD</i>	
I am aware of what Good Handling implies.	2.90	1.59	4.30*	1.52	0.88	3.70	0.95	4.80*	0.42	0.32

Producers (n = 20)

Extension Educators (n = 10)

Aspect of GAP	Retro		Post		<i>d</i>	Retro		Post		<i>d</i>
	<i>M</i>	<i>SD</i>	<i>M</i>	<i>SD</i>		<i>M</i>	<i>SD</i>	<i>M</i>	<i>SD</i>	
I understand the implications of a foodborne diseases outbreak from farm produce.	3.35	1.50	4.25*	1.52	0.60	4.10	0.88	4.70*	0.48	0.68
I know that washing hands and hygiene is a good practice.	4.15	1.50	4.45*	1.54	0.20	4.50	0.53	4.90*	0.32	0.76
I know that keeping equipment and tools clean will reduce contamination of produce.	3.60	1.57	4.35*	1.57	0.48	4.20	0.79	4.90*	0.32	0.89
I know that using properly composited fertilizer reduces the chances of contamination of fresh produce.	3.50	1.61	4.35*	1.53	0.53	3.80	1.40	4.80*	0.42	0.71
I understand that water and manure could cause contamination of disease causing organisms at farm levels.	3.20	1.71	4.40*	1.54	0.70	3.60	1.17	4.90*	0.32	1.11

	Producers ( <i>n</i> = 20)					Extension Educators ( <i>n</i> = 10)				
	Retro		Post		<i>d</i>	Retro		Post		<i>d</i>
	<i>M</i>	<i>SD</i>	<i>M</i>	<i>SD</i>		<i>M</i>	<i>SD</i>	<i>M</i>	<i>SD</i>	
I understand that a food safety plan is necessary for all farms (small and large).	2.75	1.52	4.40*	1.54	1.09	3.20	1.14	4.90*	0.32	1.49

Note. 1 = Not at all; 2= Heard of it; 3= Aware, but not understanding; 4= Aware & Understood; 5= Very Aware & Understood Clearly; Retrospective and Post Mean is significantly different, \**p* < .05; Cohen's *d* effect size interpretation: 0.20 = small effect size, 0.50 = medium effect size, 0.80 = large effect size.

### Follow-up visits

Four months after the GAP workshop, we visited six farmer participants from our workshop, evaluated their records, and found that four (66.6%) were more prepared to undergo a third-party audit in the future. Three of the farmers had begun using water that was tested and washing produce appropriately. Evidence of record keeping was found for all six farms, as all of the farmers provided receipts of produce items that were purchased by customers, and two of the farmers had implemented bar codes for traceability of their products. Producers were also taking steps to eliminate contamination from wild and domestic animals (e.g., using fake howling sounds, plastic snakes, electric fencing). However, some growers had not secured water sources, and there were few signs of wild animal feces on the farms. Growers were reminded that contaminated water could facilitate food-borne outbreaks associated with fresh produce.

### Conclusion and Discussion

Growers' limited familiarity with GAP implies a need for food safety education, which trained Extension educators, should deliver. The intervention of the GAP workshop had significant impacts on cognition, attitudes, beliefs, and intentions, which all lead to new behaviors. Producers had limited knowledge of aspects of GAP prior to the workshop, but their knowledge improved to a large degree following the workshop. Extension educators had more knowledge prior to the workshop, but their scores improved too. An important takeaway is that Extension programming about food safety practices is effective in increasing knowledge and that, therefore, more programs should be planned and delivered by Extension to make producers aware of and to help them adopt GAP.

The most striking and undesirable results in our study related to lack of written food safety plans and limited testing of irrigation water. Future train-the-trainer activities by Extension specialists and community-based programs delivered by agents should focus on written plans and water testing. Additionally, only few growers (30%) avoided using raw or partially treated manure; therefore, more education opportunities on the risks of using such soil amendments are recommended. Animal manure often contains zoonotic, pathogenic bacteria (Gerba & Smith, 2005) that can be very harmful to humans.

The FDA Food Safety Modernization Act Produce Safety Rule 2017 is final and institutes science-based minimum standards for the safe growing, harvesting, packing, and holding of fruits and vegetables grown for human consumption (FDA, 2017). Tobin, Thomson, Laborde, & Bagdon (2011) report that many local growers are concerned that meeting food safety policies will be overly demanding. Producers will need to show evidence that they have implemented food safety plans on their farms. According to Holloway et al., 2007, many consumers prefer local food or food that is sold directly by the producer. There is a substantial need to empower small produce farms to meet consumers' demand for safe produce and to be competitive in the fresh produce industry.

The GAP workshop better equipped Extension educators to train and assist farmers in their counties and to evaluate those clients' food safety practices on the farm. Educators gained knowledge needed to communicate the GAP information and assist in facilitating change toward practices that will lead to safer produce. Our conceptual model in Figure 1 was supported when some of the actual GAP (behaviors) farmers said they would implement was observed at the follow-up visits. Even though the follow-up visits were with a small number of producers, researchers and Extension educators should be encouraged by the positive results of the follow-up visits, which showed that participants were able to transform GAP information into actions after the two-day workshop.

### **Recommendations**

Producers are going to need more training on GAP, and Extension educators should develop programs accordingly. The new agriculture marketplace will require produce growers who are not only aware of GAP, but who apply them. Produce growers and Extension educators must keep up with GAP that are recommended and mandated by FSMA, other federal and state entities, and perhaps most importantly by their consumers.

### **Acknowledgments**

The material presented here is based on work that is supported by the National Institute of Food and Agriculture, U.S. Department of Agriculture.

### **References**

- Ajzen, I. (2011). Behavioral interventions: Design and evaluation guided by the theory of planned behavior. In M. M. Mark, S. I. Donaldson, & B. C. Campbell (Eds.), *Social psychology for program and policy evaluation* (74-100). New York: Guilford.
- Ajzen, I., & Fishbein, M. (1980). Understanding attitudes and predicting social behavior. *Englewood Cliffs*: Prentice-Hall.
- Davis, G. (2003). Using a retrospective pre-post questionnaire to determine program impact. *Journal of Extension*, 41 (4).
- Erickson, M. C. (2012). Internalization of fresh produce by food-borne pathogens. *Annual Review of Food Science and Technology*, (3), 283-310.
- FAO/WHO. (2008). Microbiological hazards in fresh fruits and vegetables. Meeting Report, *Microbiological Risk Assessment Series*, FAO/WHO, Geneva, Switzerland, 1-38.

- Fishbein, M., & Azjen, I. (2010). *Belief, attitude, intention and behavior: The reasoned action approach*. New York: Taylor & Francis.
- Fishbein, M., & Azjen, I. (1975). *Belief, Attitude, Intention and Behavior: An introduction to theory and research*. Reading, MA: Addison Wesley.
- Food and Drug Administration (FDA), Center for Food Safety and Applied Nutrition. (1998). *Guidance for industry: Guide to minimize microbial food safety hazards for fresh fruits and vegetables*. Retrieved July 12, 2016 from: <http://www.fda.gov/downloads/Food/GuidanceComplianceRegulatoryInformationGuidanceDocuments/ProduceandPlantProducts/UCM169112>.
- Food Safety Modernization Act. (2011). Public Law 111-353, Jan. 4, 2011. Retrieved from <http://www.gpo.gov/fdsys/pkg/PLAW-111publ353/pdf/PLAW-111publ353.pdf>.
- Gerba, C.P., & Smith J.E. (2005). Sources of pathogenic microorganisms and their fate during land application of wastes. *Journal of Environmental Quality*, 34, 42–48.
- Godin, G., & Kok, G. (1995). The theory of planned behavior: A review of its applications to health-related behaviors. *American Journal of Health Promotion*, 11, 87–98.
- Harris, L.J., Farber, J.N., Beuchat, L.R., Parish, M.E., Suslow, T.V. Garrett E.H., & Busta, F.F. (2003). Outbreaks associated with fresh produce: incidence, growth, and survival of pathogens in fresh and fresh-cut produce. *Comprehensive Reviews in Food Science and Food Safety* (2), 78–141.
- Holloway L., Kneafsey M., Venn L., Cox R., Dowler, E., Tuomainen, H. (2007). Possible food economies: A methodological framework for exploring food production–consumption relationships. *Sociologica Ruralis*, 47 (1), 1–19.
- Ilic S., Odomeru J., & LeJeune, J. T. (2008). Coliforms and prevalence of *Escherichia coli* and foodborne pathogens on minimally processed spinach in two packing plants. *Journal of Food Protection*, 71(12), 2398-403.
- Lindner, J., Rodriguez, M., Strong, R., Jones, D., & Layfield, D. (2016). Research priority area 2: New technologies, practices, and products adoptions decisions. In T. G. Roberts, A. Harder, & T. Brashears (Eds.), *American Association for Agricultural Education national research agenda: 2016-2020* (19-27). Gainesville, FL: Department of Agricultural Education and Communication.
- Little, C.L., & Gillespie, I.A. (2008). Prepared salads and public health. *Journal of Applied Microbiology*. 105 (6), 1729-43.
- Raison, B., Educators or facilitators? Clarifying Extension’s role in the emerging local food systems movement. *Journal of Extension*, 48 (3).
- Rohs, F. (1999). Response-shift bias: A problem in evaluating leadership development with self-report pretest-posttest measures. *Journal of Agricultural Education*, 40 (4), 28-37.

- Roberts, T. G., Harder, A., & Brashears, M. T. (Eds). (2016). *American Association for Agricultural Education national research agenda: 2016-2020*. Gainesville, FL: Department of Agricultural Education and Communication.
- Sivapalasingam, S., Friedman, C. R., Cohen, L., & Tauxe, R. V. (2004). Fresh produce: A growing cause of outbreaks of foodborne illness in the United States, 1973 through 1997. *Journal of Food Protection*, 67(10), 2342-2353.
- Suslow, T. V., Oria, M. P., Beuchat, L. R., Garret, E.H., Parish, M.E., Harris, L.J., Farber, J.N., & Busta, F.F. (2003). Production practices as risk factors in microbial food safety of fresh and fresh-cut produce. *Comprehensive Reviews in Food Science and Food Safety*, (2), 38–77.
- Tobin, D., Thomson, J., Laborde, L. F., & Bagdonis, J. (2011), Developing GAP training for growers: Perspectives from Pennsylvania Supermarkets, *Journal of Extension*, 45 (5), 5IRB7.
- Warriner K, Huber A, Namvar A, Fan W, & Dunfield K. (2009). Recent advances in the microbial safety of fresh fruits and vegetables. *Advances in Food and Nutrition Research*, (57) 155–208. doi: 10.1016/S1043-4526 (09) 57004-0.
- Zanna, M. P., & Rempel, J. K. (1988). Attitudes: A new look at an old concept. In D. Bar-Tal & A. W. Kruglanski (Eds.). *The social psychology of knowledge* 315-334. Cambridge, England: Cambridge University Press.

## **Identifying Generational Differences to Target Extension Programming when Discussing Genetic Modification**

Peyton N. Beattie, University of Florida  
Dr. Alexa J. Lamm, University of Florida  
Dr. Joy N. Rumble, University of Florida  
Dr. Jason D. Ellis, Kansas State University

*Genetic modification (GM) science has received considerable pushback from consumers despite the research finding GM products are safe for consumption. This may be partly due to the disconnect between consumers and farms since most consumers are disconnected from the farm by at least three generations. The largest consumer population is composed of millennials, which is the generation furthest removed from the farm which may mean they need to be educated differently about GM science than other generations. The purpose of this research was to determine if there were generational differences regarding the perceived attributes of GM science to inform the development of extension programs designed to educate consumers about GM science so they are educated when making purchasing decisions. A survey was used to collect consumers' perceptions of GM science. The respondents were grouped into generational classifications and perceptions between groups were compared. The findings revealed generations do perceived GM science differently and extension programs should be designed for specific generational audiences.*

### **Introduction**

The topic of GM science has become one of much controversy stemming from consumer perceptions that GM food products are a cause for concern despite research findings supporting their safety (Mahgoub, 2016). Consumers often develop their perceptions emotionally, due largely to biased media reporting rather than from an educated, informed perspective (Mahgoub, 2016). It has been hypothesized that consumers' lack information about agriculture impacting their decision-making because, on average, most consumers are disconnected from farming or agriculture by three generations (American Farm Bureau Federation, 2017). Recent research highlighted the farm to consumer disconnect with research findings indicating consumers in major citrus producing states (Florida, California, and Texas) reported regularly purchasing citrus but over half did not believe their community's economy was dependent upon the citrus industry (Ruth, Beattie, Lamm & Rumble, 2017). Therefore, an opportunity exists for Extension agents to take GM science research conducted at land grant universities, translate it into understandable information, and disseminate it to their local communities in order for the public to be better informed when purchasing food.

The consumer population is largely composed of millennials (Hais & Winograd, 2011); the generation farthest removed from production agriculture (Fyksen, 2017). Millennials have the largest purchasing power (Hais & Winograd, 2011) but are not the only consumers involved in the purchasing and consumption of food. Baby boomers, generation Xers, and traditionalists are



also a part of the education, decision-making, and food purchasing equation. There is a need to decrease the farm to consumer gap through educational programming so consumers can make informed food purchasing decisions (King, Tietyen, & Vickner, n.d.). Extension agents will be more effective at developing effective consumer programs targeted towards specific generational groups if they understand how different generations perceive GM attributes. This research aligns with the American Association of Agricultural Education (AAAE) National Research Agenda priority five, developing ways to better communicate with diverse audiences. (Thoron, Myers, & Barrick, 2016). In addition to better understanding generations as audiences this study aims to address complex problem which aligns with research priority seven of the AAAE National Research Agenda (Andenoro, Baker, Stedman, & Weeks, 2016).

Generations are groups of individuals, in this case consumers, that are classified by the events, trends, and changes that occurred in the time-period of their birth year (The Center for Generational Kinetics, 2016). Trends that are responsible for forming the identity of generational groups are parents, technology, and economics (The Center for Generational Kinetics, 2016). Millennials were born between the years 1981 and 2000 (The Center for Generational Kinetics, 2016) and constitute 30% of the adult population (Pew Research Center, 2015). Although millennials are the youngest generations among the adult population, they are on the fast track to becoming the United States' "largest living generation" and will soon be the force "driving changes" around the types of foods consumers purchase (Duff & Phelps Corporation, 2016, p. 6). Millennials depend on the opinions of others and outside sources to guide their purchasing decisions and are expected to struggle with financial management (U. S. News and World Report, 2014).

Generation Xers were born between the years 1965 and 1980 (The Center for Generational Kinetics, 2016) and are responsible for 27% of the adult population (Pew Research Center, 2015). Generation Xers are the informed generation. The development of the internet and other technologies occurred during this generation. Their increased access to information has made them the most involved generation in researching products before purchasing (Williams, n.d.).

Baby Boomers were born between the years 1946 and 1964 (The Center for Generational Kinetics, 2016) and make up 30% of the adult population (Pew Research Center, 2015). The Baby Boomer generation tends to be brand loyal, informed, and financially stable (U. S. News & World Report, 2015). Traditionalists were born prior to the year 1945 (The Center for Generational Kinetics, 2016) and only constitute 11% of the population (Pew Research Center, 2015). Traditionalists are traditional in their values, hesitate to change, and are consistent in their brand devotion (Williams & Page, 2013).

### **Theoretical Framework**

Rogers' (2003) diffusion of innovations theory guided the framework of this study. Diffusion of innovations theory describes the process in which a new idea is diffused through a social system (Rogers, 2003). More specifically the process includes "(1) an *innovation* (2) [being]

*communicated through certain channels (3) over time (4) among the members of a social system”* (Rogers, 2003, p. 11). An innovation is recognized as any idea, technological advancement, or product that is perceived as new to an individual or unit. Communication channels are the space where those who are familiar with the innovation communicate with the less familiar to generate an understanding of the innovation. Time is the variable in which the decision to adopt or reject the innovation is formulated. The social system where the innovation is diffused acts as a constraint in norms, belief, views, etc. and ultimately effects the individual or unit’s decision to adopt or reject an innovation (Rogers, 2003).

Rogers (2003) identifies five attributes of an innovation that should impact rate of adoption: relative advantage, compatibility, complexity, observability, and trialability. Relative advantage is the idea that the innovation possesses characteristics that are perceived to be advantageous as compared to the characteristics of the idea, product, or technology being replaced (Rogers, 2003). Compatibility is defined as how closely the innovation aligns with “existing values, past experiences, and needs” (Rogers, 2003, p. 240). The complexity of an innovation includes the difficulty level and level of knowledge needed to successfully use the innovation (Rogers, 2003). The observability of an innovation is described as how visible the innovation is to the people in the social system in which the innovation is being diffused (Rogers, 2003). Finally, trialability is the ability to sample the innovation before engaging in adoption or rejection of the innovation (Rogers, 2003). The degree to which each of these five attributes are experienced with the innovation builds the positive or negative perception of the innovation by the individual or unit in the social system in which the innovation was diffused (Rogers, 2003).

Previous research has been conducted examining generational differences in the adoption of new technologies. Blackburn (2011) found millennials bring large amounts of expertise in technological advancements to the learning environment (in this case a library) which, in turn, positively impacts efficiency. Blackburn (2011) suggested libraries should consider a millennial workforce due to their level of technology knowledge that could assist with the adoption of new technologies.

Quan-Haase, Martin, and Schreurs (2014) conducted a study of the traditionalist generation and their adoption of e-book technology. They found most of their research participants were aware of e-book technology but had yet to make a decision to adopt or reject the innovation (Quan-Haase et al., 2014). Three factors were found that hindered traditionalist’s adoption of e-books: the e-books lacked the physical book and print aspect, the e-book innovation lacked the trialability attribute, and traditionalists lacked confidence to navigate a new technology.

A study conducted by Gafni and Geri (2013) discussed Generation X’s use of smartphones and the adoption of the internet capabilities on the smartphones as compared to Generation Y or millennials. The results indicated that Generation Xers have been more likely to use smartphones in the last 12 years, compared to a 25-year time span. However, progression of time did not increase the likelihood of Generation Xers using the internet capabilities on their smartphones. Therefore, this study indicated that Generation Xers were slower in their adoption of technology

and have not fully adopted all of the capabilities of the technology as compared to Generation Y or millennials (Gafni & Geri, 2013).

Rumble, Ruth, Owens, Lamm, Taylor, and Ellis (2016) conducted a study of millennial's perceptions of GM science and their likelihood to adopt GM citrus products. The study indicated that 56.1% millennial respondents would be likely or extremely likely to consume GM citrus products. The study also indicated that the compatibility attribute of an innovation was a predictor of their likelihood to consume GM citrus products (Rumble et al., 2016).

### **Purpose and Objectives**

The purpose of this study was to determine if differences existed in the perceived adoption characteristics of GM science. It was conducted to inform the development of extension programs focused on educating about GM science to a variety of generational audiences. The purpose was addressed through the following objectives:

1. Describe the perceived relative advantage, compatibility, complexity, observability, and trialability of GM science within each generation; and
2. Determine if there are statistical differences between the perceived attributes of GM science by generation.

### **Methods**

This study was a part of a larger study designed to understand U.S. consumer perceptions of GM science. An online survey was developed and reviewed by a panel of experts. The survey was pilot tested with slight revisions made to ensure internal and external validity and reliability of the constructs. Responses were collected using non-probability, opt-in sampling techniques (Baker et al., 2013). U.S. residents ages 18 and older were invited to participate in the online survey. Of the 1,751 invited to participate, 1,047 completed responses were returned after quota sampling and attention filters were met which accounts for a 60% usable response rate. The survey data was weighted to reflect the 2010 U.S. Census data to increase generalizability of the results to U.S. consumers (Baker et al., 2013).

First, survey respondents were asked to indicate the year in which they were born. The years reported by the respondents were then recoded into generational categories: 1981-2000 = Millennials, 1965-1980 = Generation X, 1946-1964 = Baby Boomers, before-1945 = Traditionalist (The Center for Generational Kinetics, 2016). Perceptions of the five attributes of GM science were then measured using respondent reactions to a series of statements for each attribute.

Perceived relative advantage was measured using a five-point Likert type scale. Respondents were asked to indicate their level of agreement or disagreement to the following statements: GM science enhances the taste of food, GM science increases the amount of food a farmer can grow, GM science reduces the use of pesticides, GM science combats plant disease, GM science makes

food more affordable, GM science enables plants to grow when less water is available, GM science is part of a solution to end world hunger, and GM science fosters more opportunities for the next generation. The responses to the eight statements were averaged to create a relative advantage index. Reliability was measured *post hoc* ( $\alpha = .92$ ).

Consumers' perceived compatibility was measured using a five-point Likert type scale. Respondents were asked to indicate their level of agreement or disagreement with the following statements as they pertain to GM science: developments in GM science help make society better, GM science is essential for improving the quality of human lives, GM science does not pay attention to the moral of society, GM science makes out way of life change too fast, even if it brings no immediate benefit GM science that advances knowledge is necessary, and overall GM science does more harm than good. The responses to the six statements were averaged to create a compatibility index. Reliability was measured *post hoc* ( $\alpha = .74$ )

Perceived complexity was measured using a semantic differential scale. Survey respondents were asked to select the circle between each set of adjectives that best represents their thoughts about GM science. The sets of adjectives included: complex/simple, easy to understand/difficult to understand, clear/unclear, confusing/straightforward, ambiguous/definitive, and complicated/not complicated. The responses to the six sets of adjectives were averaged to create a complexity index. Reliability was measured *post hoc* ( $\alpha = .83$ ).

Consumers' perceived observability was measured using a semantic differential scale. Respondents were asked to select the circle between each set of adjectives that best represents their thoughts about GM science. The sets of adjectives included: easy to identify/difficult to identify, something I can observe/something I cannot observe, obvious/not obvious, evident/concealed, visible/invisible, and disclosed/withheld. The responses to the six sets of adjectives were averaged to create an observability index. Reliability was measured *post hoc* ( $\alpha = .92$ ).

Lastly, perceived trialability was measured using a five-point Likert type scale. Respondents were asked to indicate their level of agreement or disagreement with the following statements as they pertain to GM science: food products that result from plants made with GM science are easy to try, food products that result from plants made with GM science are readily available to test before I buy, I can easily try food products that result from plants made with GM science in a grocery store, the opportunity to try food products that result from plants made with GM science is not available to me, if given the opportunity I would try food products that results from plants made with GM science, and I want the opportunity to try out food products that result from plants made with GM science before deciding whether I like them or not. The statement *the opportunity to try food products that result from plants made with GM science is not available to me* was removed before creating the trialability construct in order for the construct to be reliable. The remaining five statements were averaged to create a trialability index. Reliability was measured *post hoc* ( $\alpha = .66$ ).

Mean scores and standard deviations were interpreted using the real limits of the scale: 1.00 - 1.49 = *strongly disagree*, 1.50 - 2.49 = *disagree*, 2.50 - 3.49 = *neither agree nor disagree*, 3.50 - 4.49 = *agree*, 4.50 - 5.00 = *strongly agree*. ANOVAs were used to determine if generational differences existed. Tukey post hoc tests were used to identify specific differences between groups.

## Results

For the most part respondents indicating being millennials and generation Xers were similar in their responses. Respondents in both groups agreed GM science provided a relative advantage, whereas millennials and generation Xers neither agreed nor disagreed GM science was compatible, complex, or observable (Table 1). Millennials agreed with the trialability of GM science, whereas generation Xers neither agreed nor disagreed on their perceptions of GM science trialability.

Respondents indicating being in the baby boomer and traditionalist generations were also similar. The baby boomers and traditionalists neither agreed nor disagreed that GM science provided a relative advantage, was compatible, or provided trialability characteristics. The baby boomer and traditionalist generations disagreed GM science is observable. The baby boomers and traditionalists differed in their perceptions of GM science's complexity. The baby boomers neither agreed nor disagreed it was complex, where the traditionalists disagreed that GM science was complex.

Table 1  
*Perceived Attributes of GM Science by Generation*

	Millennials <i>n</i> = 333	Generation X <i>n</i> = 295	Baby Boomers <i>n</i> = 312	Traditionalist <i>n</i> = 107
	<i>M</i> ( <i>SD</i> )	<i>M</i> ( <i>SD</i> )	<i>M</i> ( <i>SD</i> )	<i>M</i> ( <i>SD</i> )
Relative Advantage	3.78 (.64)	3.63 (.78)	3.40 (.77)	3.44 (.73)
Compatibility	3.42 (.59)	3.19 (.71)	3.18 (.79)	3.28 (.77)
Complexity	2.87 (.76)	2.69 (.81)	2.59 (.77)	2.45 (.65)
Observability	3.12 (.89)	2.69 (1.00)	2.41 (.94)	2.13 (.72)
Trialability	3.62 (.63)	3.34 (.70)	3.15 (.64)	3.23 (.54)

Note. Real limits of the scale: 1.00 - 1.49 = *strongly disagree*, 1.50 - 2.49 = *disagree*, 2.50 - 3.49 = *neither agree nor disagree*, 3.50 - 4.49 = *agree*, 4.50 - 5.00 = *strongly agree*

ANOVAs were used to determine if statistical differences existed between the generational groups for the five attribute indices (Table 2). Statistical differences were found for all five of the attributes.

Table 2  
*Differences in Perceived Attributes between Generational Groups*

	<i>F</i>	<i>p</i>
Observability	46.73	.00**

Trialability	30.00	.00**
Relative Advantage	16.03	.00**
Complexity	11.59	.00**
Compatibility	7.92	.00**

Note. \*\* $p < .01$

Tukey post hoc tests were run to determine which specific generational groups had significant differences for each of the five attributes. The differences in the generational groups for the relative advantage attribute are depicted in Table 3. Baby boomers and traditionalists differed significantly from millennials in their perceptions of the relative advantage of GM. Baby boomers also differed significantly in their perceptions to the generation X group.

Table 3  
*Tukey Post Hoc Test for Relative Advantage*

Generation	Generation Comparison	Mean Difference	$p$
Millennials	Generation X	.15	.06
	Baby Boomers	.38	.00**
	Traditionalist	.34	.00**
Generation X	Millennials	-.15	.06
	Baby Boomers	.23	.00**
	Traditionalist	.19	.10
Baby Boomers	Millennials	-.38	.00**
	Generation X	-.23	.00**
	Traditionalist	-.04	.97
Traditionalist	Millennials	-.34	.00**
	Generation X	-.19	.10
	Baby Boomers	.04	.97

Note. \*\* $p < .01$

Consumers in the generation X and baby boomer generations' perceptions of the compatibility of GM science differed significantly from the perceptions of the millennial generation (Table 4). The millennial generation had a higher mean score on their perceptions of compatibility of GM than the traditionalist generation, whereas the traditionalist generation had a higher mean score than the baby boomers and the generations Xers. However, the differences between the traditionalist generation and the other generations was not significant.

Table 4  
*Tukey Post Hoc Test for Compatibility*

Generation	Generation Comparison	Mean Difference	$p$
Millennials	Generation X	.23	.00**
	Baby Boomers	.24	.00**
	Traditionalist	.14	.29
Generation X	Millennials	-.22	.00**
	Baby Boomers	.02	.99

Baby Boomers	Traditionalist	-.09	.71
	Millennials	-.24	.00**
	Generation X	-.02	.99
Traditionalist	Traditionalist	-.10	.55
	Millennials	-.04	.29
	Baby Boomers	.09	.71
	Generation X	.10	.55

Note. \*\* $p < .01$

The millennial consumers' perceptions of the complexity of GM science differed significantly from the perceptions of the consumers in the generation X, baby boomer, and traditionalist groups (Table 5). In addition, millennials' perceptions had a higher mean score than the other three generation groups. Traditionalists differed significantly in their perceptions of the complexity of GM science from generation Xers.

Table 5  
*Tukey Post Hoc Test for Complexity*

Generation	Generation Comparison	Mean Difference	$p$
Millennials	Generation X	.18	.02*
	Baby Boomers	.28	.00**
	Traditionalist	.43	.00**
Generation X	Millennials	-.18	.02*
	Baby Boomers	.10	.35
	Traditionalist	.25	.02*
Baby Boomers	Millennials	-.28	.00**
	Generation X	-.10	.35
	Traditionalist	.14	.34
Traditionalist	Millennials	-.43	.00**
	Generation X	-.25	.02*
	Baby Boomers	-.14	.34

Note. \*\* $p < .01$ , \* $p < .05$

The perceptions of the observability of GM science differed significantly in every generation group (Table 6). Millennials had a higher mean score than generation X, baby boomer, and traditionalist generations. Millennial, generation Xer, and baby boomer consumers had higher mean scores than the traditionalist consumers.

Table 6  
*Tukey Post Hoc Test for Observability*

Generation	Generation Comparison	Mean Difference	$p$
Millennials	Generation X	.43	.00**
	Baby Boomers	.71	.00**
	Traditionalist	.99	.00**
Generation X	Millennials	-.43	.00**
	Baby Boomers	.28	.00**

Baby Boomers	Traditionalist	.56	.00**
	Millennials	-.71	.00**
	Generation X	-.28	.00**
Traditionalist	Traditionalist	.28	.03*
	Millennials	-.99	.00**
	Generation X	-.56	.00**
	Baby Boomers	-.28	.03*

Note. \*\*  $p < .01$ , \*  $p < .05$

The millennial consumers perceived the trialability of GM science differently than the generation X, baby boomer, and traditionalist generations (Table 7). The difference was significant, and millennials had a higher mean score compared to the other three generation groups. Generation X differed significantly in their perceptions compared to the baby boomer generation where generation X had the higher mean score.

Table 7  
*Tukey Post Hoc Test for Trialability*

Generation	Generation Comparison	Mean Difference	$p$
Millennials	Generation X	.28	.00**
	Baby Boomers	.47	.00**
	Traditionalist	.39	.00**
Generation X	Millennials	-.28	.00**
	Baby Boomers	.19	.00**
	Traditionalist	.11	.43
Baby Boomers	Millennials	-.47	.00**
	Generation X	-.19	.00**
	Traditionalist	-.08	.68
Traditionalist	Millennials	-.39	.00**
	Generation X	-.11	.43
	Baby Boomers	.08	.68

Note. \*\* $p < .01$

## Conclusions

The results indicated that generational groups perceive GM science differently, affecting the rate in which the generations may be adopting GM science. Blackburn (2011) indicated that the millennial generation is more likely to engage in new technologies and more willing adopt new technologies compared to other generations. The findings from this study confirmed this to a certain degree. In this study millennials did agree GM science provided a relative advantage, however the millennials were neutral in their perceptions of GM science offering compatibility, complexity, observability, and trialability. Generation X perceived GM science similarly to the millennial generation which is in opposition to Blackburn's findings.

Quan-Haase et al. (2014) found a majority of traditionalists had not adopted e-book technology, some were unaware of the technology and some were aware and chose not to adopt. These



finding are partially consistent with the findings of this GM study. Of the four generations, the traditionalist generation disagreed with two attributes of an innovation, complexity and observability. The traditionalists were neutral in their perceptions of GM science in regards to its relative advantage, compatibility, and trialability. Quan-Haase et al. (2014) indicated traditionalist were hesitant to adopt because there was a lack of trialability of the e-book technology. Result of this study indicated the same, as traditionalist were neutral on their perceptions of the trialability of GM products.

Gafni and Geri (2013) found Generation Xers were slower in their adoption of smartphone technologies and did not fully adopt the technologies capabilities as compared to generation Y or millennials. The results of this study are similar. Millennials and generation Xers were most similar in their perceptions, taking into consideration all four generation groups. However, when comparing millennials and generation Xers, millennials agreed with two attributes and neither agreed nor disagreed with three. Whereas, generation Xers only agreed with one attribute and neither agreed nor disagreed with four attributes.

The study conducted by Rumble et al. (2016) indicated that over half of the millennial respondents would be likely to consume GM food products. The results of this study indicated the millennial generation agreed with the most attributes compared to the other three generation groups. Rumble et al. (2016) indicated that the millennial generation was most likely to consume GM citrus products if the products were compatible. This result differs from the findings of this study which indicated millennials neither agreed nor disagreed GM science was compatible.

### **Implications and Recommendations**

Due to the generational differences in perceptions of GM science, Extension agents should target specific generations when developing educational efforts about GM science. In terms of relative advantage, millennial's and generation x's views aligned closely with each other where baby boomers and traditionalists perceived relative advantage similarly. Therefore, when facilitating outreach efforts to educate consumers around GM science's relative advantages millennials and generation Xers should be a target audience group and baby boomers and traditionalists should be another target audience group. The millennial and generation X generations had a more positive perception of GM science's relative advantages, whereas baby boomers and traditionalist were more conservative with their perceptions. With this, Extension agents can provide programming for baby boomers and traditionalists in areas that focus on their perceptions of the relative advantages of GM science. Agents can focus efforts to share with consumers unbiased, university researched information on how products made using GM science can be advantageous in price, health, safety, quality, and efficiency.

Mixing audience groups could help opposing audiences understand both the positive and negative aspects of GM science. Providing a space where a discussion can be facilitated and mediated by an unbiased professional to discuss both sides of the GM science debate can be helpful. Facilitated discussions can include but are not limited to topics such as what stance do

you take, what events led you to take this stance, why do you believe your stance is better than the opposing, would you consider eating food from the opposing stance, and what facts would you share about your stance. The discussion could lead both parties to a better and more informed understand of both sides and lead to educated purchasing decisions.

The results of this study indicated all four generations' perceptions of both compatibility and trialability of GM science were similar, implying members of all five generations can be grouped together when outreach efforts target the compatibility of GM science. Because perceptions across all generational groups are similar for the compatibility of GM science, Extension agents should be diligent in providing outreach materials that capture positive and negative features of GM science. Creating opportunities for consumers to experience or try GM science-related items can be presented in the form of field days to talk with farmers that grow GM crops, opportunities to speak with scientists, and chances to try GM and non-GM food products

Traditionalists viewed the complexity of GM science more negatively than the other generations. However, millennials viewed the complexity of GM science differently than those from other generations. There were also differences in the views of generation Xers and traditionalist. The findings imply that when carrying out outreach in the space of complexity of GM science, millennials should be targeted as a group of their own, and baby boomers and traditionalist can be segmented audience. Complexity can be addressed by Extension agents as it pertains to each generation group. Assessing the needs of each group in terms of what they find complex about GM science will help Extension agents provide appropriate programming for the segmented audience. Points of complexity could include lack of knowledge, misinformation, lack of resources, or miscommunication.

Millennials and generation Xers perceived the observability of GM similarly, as well as, baby boomers and traditionalists. Outreach efforts around the observability of GM science should be targeted towards the groups reflective of their similar perceptions. Ensuring that your segmented audiences are educated on both sides of the GM science story will help consumers develop a well-rounded level of knowledge of GM science and be able to make educated decisions about whether they accept or reject GM science as an innovation. In an effort to make GM science more observable to consumers, social media campaigns can be formed, videos can be composed, and live experiences can be created for consumer to have opportunities to interact with various aspects of GM science. Aspects of GM science can include but are not limited to GM crops, GM science labs, GM food in the grocery store, or other GM products.

Duff and Phelps Corporation (2016) indicated that the millennial generation will have the largest consumer purchasing power. Millennials should largely be the target audience for GM science extension programs because of their predominant stake in the consumer market. In addition to their ability to control changes in purchasing trends (Duff & Phelps Corporation, 2016), millennials are the farthest generation removed from the agriculture industry (American Farm Bureau Federation, 2017). A better understanding of agriculture and the root of their food supply

will better educate millennial consumers and guide them in their decision process to accept or reject GM science.

Future research on the generational difference in consumers' perceptions of GM science is needed to develop appropriate programming to meet consumers where they are in their perceptions. Future studies should be conducted to investigate which specific barriers related to each attribute keep consumers from adopting GM science. Findings of this study can more specifically guide the content of Extension programming. Also, research can be conducted to understand consumer perceptions according to segments other than generations. Other segments that should be investigated include regional location in the US, gender, religion, age, and rural or urban residences, to name a few. Results from this study can help Extension agents provide their specific audience with the content needed to become educated purchasing consumers.

## References

- American Farm Bureau Federation. (2017). *Our food link*. Retrieved from <http://www.fb.org/programs/womens-leadership-program/our-food-link/>
- Andenoro, A. C., Baker, M., Stedman, N. L. P., & Weeks, P. P. (2016). Addressing complex problems. In *American Association of Agricultural Education National Research Agenda* (Research Priority 7). Retrieved from [http://aaaeonline.org/resources/Documents/AAAE\\_National\\_Research\\_Agenda\\_2016-2020.pdf](http://aaaeonline.org/resources/Documents/AAAE_National_Research_Agenda_2016-2020.pdf)
- Baker, R., J. M. Brick, N. A. Bates, M. Battaglia, M. P. Couper, J. A. Dever, & R. Tourangeau. (2013). *Report of the AAPOR task force on non-probability sampling*. American Association for Public Opinion Research.
- Blackburn, H. (2011). Millennials and the adoption of new technologies in libraries through the diffusion of innovations process. *Library Hi Tech*, 29(4), 663-677. Retrieved from <http://www.emeraldinsight.com/doi/pdfplus/10.1108/0737883111189769>
- Duff and Phelps Corporation. (2016). *Industry insights: Food retail industry insights*. Retrieved from <http://www.duffandphelps.com/assets/pdfs/publications/mergers-and-acquisitions/industry-insights/consumer/food-retail-industry-insights-2016.pdf>
- Fyksen, J. (2017, May). Ag advocate says farmers must share stories. *Ag Update*. Retrieved from [http://www.agupdate.com/news/state\\_news/ag-advocate-says-farmers-must-share-stories/article\\_89f3f487-1e30-5aeb-acaf-17487f4d183e.html](http://www.agupdate.com/news/state_news/ag-advocate-says-farmers-must-share-stories/article_89f3f487-1e30-5aeb-acaf-17487f4d183e.html)
- Gafni, R., & Geri, N. (2013). Generation Y versus generation X: Differences in smartphone adaptation. *Proceedings of the Chais Conference on Instructional Technologies Research*. Retrieved from [http://innovation.openu.ac.il/chais2013/download/b1\\_4.pdf](http://innovation.openu.ac.il/chais2013/download/b1_4.pdf)
- Hais, M., & Winograd, M. (2011, May 1). Put millennials first. *The Huffington Post*. Retrieved from [http://www.huffingtonpost.com/michael-hais-and-morley-winograd/put-millennials-first\\_b\\_856082.html](http://www.huffingtonpost.com/michael-hais-and-morley-winograd/put-millennials-first_b_856082.html)
- King, B. S., Tietyen, J. L., & Vickner, S. S. (n.d.). *Food and agriculture: Consumer trends and opportunities*. IP-58A. Lexington: University of Kentucky Cooperative Extension Service. Retrieved from <http://www2.ca.uky.edu/agcomm/pubs/ip/ip58a/ip58a.pdf>
- Mahgoub, S. E. O. (2016). *Genetically modified foods: Basics, applications, and controversy*. Boca Raton, FL: CRC Press.

- Pew Research Center. (2015). The whys and hows of generations research. *U. S. Politics and Policy*. Retrieved from <http://www.people-press.org/2015/09/03/the-whys-and-hows-of-generations-research/>
- Quan-Haase, A., Martin, K., & Schreurs, K. (2014). Not all on the same page: E-book adoption and technology exploration by seniors. *Information Research*, 19(2). Retrieved from <http://www.informationr.net/ir/19-2/paper622.html#.WU6OfoWcFaM>
- Rogers, E. M. (2003). *Diffusion of innovations* (5th ed.). New York, NY: Free Press.
- Rumble, J. N., Ruth, T. K., Owens, C. T., Lamm, A. J., Taylor, M. R., & Ellis, J. D. (2016). Saving citrus: Does the next generation see GM science as a solution? *Journal of Agricultural Education*, 57(4), 160-173. <https://doi.org/10.5032/jae.2016.04160>
- Ruth, T. K., Beattie, P. N., Lamm, A. J., & Rumble, J. N. (2017, February). Citrus greening solutions: Extension's role in Florida, California, and Texas. *Proceedings of the Southern Association of Agricultural Sciences Conference*, Mobile, AL. Retrieved from <http://aaaeonline.org/resources/Documents/Southern%20Region/2017%20Southern%20AAAE%20Poster%20Proceedings.pdf>
- The Center for Generational Kinetics. (2016). Generational breakdown: Info about all of the generations. *An intro to generations*. Retrieved from <http://genhq.com/faq-info-about-generations/>
- Thoron, A., Myers, B. E., & Barrick, K. (2016). Efficient and effective agricultural education programs. In *American Association of Agricultural Education National Research Agenda* (Research Priority 5). Retrieved from [http://aaaeonline.org/resources/Documents/AAAE\\_National\\_Research\\_Agenda\\_2016-2020.pdf](http://aaaeonline.org/resources/Documents/AAAE_National_Research_Agenda_2016-2020.pdf)
- U. S. News & World Report. (2015). *Baby boomer report*. Retrieved from [https://www.usnews.com/pubfiles/USNews\\_Market\\_Insights\\_Boomers2015.pdf](https://www.usnews.com/pubfiles/USNews_Market_Insights_Boomers2015.pdf)
- U. S. News & World Report. (2014). *Millennial report*. Retrieved from [https://www.usnews.com/pubfiles/USNews\\_Market\\_Insights\\_Millennials2014.pdf](https://www.usnews.com/pubfiles/USNews_Market_Insights_Millennials2014.pdf)
- Williams, E. (n. d.). *Generation X consumer behavior*. Retrieved from <http://yourbusiness.azcentral.com/generation-x-consumer-behavior-9585.html>
- Williams, K. C., & Page, R. A. (2013). Marketing to the generations. *Journal of Behavioral Studies in Business*, 6. Retrieved from <http://www.aabri.com/manuscripts/10575.pdf>

# Framework for School Garden Program Development and Evaluation: A Delphi Approach

John M. Diaz, University of Florida  
Laura A. Warner, University of Florida  
Susan T. Webb, University of Florida

## Abstract

School gardens programs and garden-based education are positioned to become fixtures in educational institutions given recent trends and the national interest in gardens at school sites. Agricultural education professionals have integrated school gardens into core science, social studies, math, and language arts courses as well as agricultural education programs for elementary, middle, and high school curriculum. The literature shows that while there are specific curriculum links being made, school garden programs elicit a multitude of benefits in addition to enhancing student performance. Although the literature outlines an extensive set of impacts that may result from a school garden program, they are grounded in a specific case or intervention. Those who are planning for and evaluating school garden programs are left to make connections based on case study results or intervention trials, which leaves plenty of room for error. We utilized the Delphi approach with a panel of 74 experts to identify consensus on 38 outcomes that should be used to inform program development and evaluation efforts. Agricultural education professionals and other stakeholders connected to school gardens can use the results of this study to provide a solid foundation for an outcome-driven school garden program.

Keywords: Program development, program evaluation, outcomes framework, school gardens

## Introduction

A resurgence of interest in school garden programs came about in the early 1990s that resulted in the development of thousands of gardens on school sites across the country (Duncan, et al., 2016; Williams & Dixon, 2013). These gardens were not only located in urban areas but rural areas as well. School garden programs continue to grow across the country and receive national attention for the breadth of possible impacts from gardening and garden-based education. School standards are becoming aligned with newly designed garden curricula as these curricula emerge in schools, districts and state education departments (Williams & Dixon, 2013).

School gardens programs and garden-based education are positioned to become fixtures in educational institutions given recent trends and the national interest in gardens at school sites (Hayden-Smith, 2006; Williams & Dixon, 2013). The literature shows that while there are specific curriculum links being made with science, language arts, mathematics, social studies and writing; school garden programs exhibit a multitude of purposes and benefits. Williams and Dixon (2013) conducted a comprehensive survey of the literature and effectively outlined these purposes to include:

“(a) personal, social, physical, and moral development that also addresses self-concept, self-esteem, and motivation (Bowker & Tearle, 2007; Dirks & Orvis, 2005; Hendren, 1998; O’Brien & Shoemaker, 2006; Robinson & Zajicek, 2005; Sheffield, 1992; Simone,

2003); (b) positive environmental attitude and empathy (Berenguer, 2007; Dirks & Orvis, 2005; Skelly & Zajicek, 1998; Waliczek & Zajicek, 1999); (c) increased food literacy and healthy eating habits (Canaris, 1995; Koch, Waliczek, & Zajicek, 2006; Lineberger & Zajicek, 2000; Morris, Neustadter, & Zidenberg-Cherr, 2001; Parmer, Salisbury-Glennon, Shannon, & Struempfer, 2009; P. J. Morgan et al., 2010); and (d) school bonding, parental involvement, and formation of community (Brink & Yost, 2004; Brunotts, 1998; Cutter-Mackenzie, 2009; Mayer-Smith, Bartosh, & Peterat, 2009; Waliczek, Logan, & Zajicek, 2003)” (p. 212).

Williams and Dixon’s work (2013) along with the work of Berezowitz, Yoder and Schoeller (2015) also found that curriculum connections being made by school gardens enhance academic performance among its students.

Agricultural education professionals engage in school gardening programs in various ways including integration into core science, social studies, math, and language arts courses as well as agricultural education programs for elementary, middle, and high school curriculum (Duncan et al., 2016; Graves, Hughes, & Balgopal, 2016). The success of these programs and the national school garden movement has relied on the support of many sectors and diverse stakeholder groups including farmers, non-profits, school administrators and teachers, parents, business, and food service as well as universities and cooperative extension (Feenstra & Ohmart, 2012). Estimates indicate approximately one in five Extension professionals are involved in school or community gardens (Benson, 2014). Extension professionals and their volunteers may support school garden initiatives by providing horticulture, nutrition, and food safety expertise and instruction (Black, Haynes, Schrock, Duerfeldt, & Litchfield, 2016; Dzubak, Shaw, Strohbahn, & Naeve, 2016). Additionally, farm to school programs connect local farms and schools in an effort to improve student nutrition, support producers, and provide education (Benson, 2014). Extension evaluation specialists may also play a role in guiding impactful school garden planning and evaluation.

Although the aforementioned literature outlines an extensive set of impacts that may result from a school garden program, they are grounded in specific cases or interventions. Those who are planning for and evaluating school garden programs are left to make connections based on case study results or intervention trials, which leaves plenty of room for error (Slavin, 2008). Also one of the challenges in extension programming for school gardens is the need to create a cohesive approach to support diverse programs that are composed differently and have different goals. Educators and other key stakeholders would benefit from a set of outcomes that cover a variety of school garden functions organized in the logical sequence of impacts following program engagement. By providing such results, educators and support organizations can better plan their programs and understand when and how to collect data to understand their aggregate programmatic impacts (Israel, 2001).

### **Theoretical Framework**

Utilizing principles of backward design (Wiggins & McTighe, 2005), agricultural educators have the opportunity to develop a program theory of change that focuses on mapping out the function of the program and how they lead to desired goals to be achieved (CTC, 2016). This process begins by identifying desired long-term goals and works backwards in identifying all the conditions that must be in place for the goals to occur, providing an outcomes framework (CTC, 2016). The outcomes framework provides the basis for identifying what type of activities

will lead to the desired outcomes necessary to achieve the long-term goal and provides additional clarity on the precise link between activities and goal achievement (CTC, 2016). This approach promotes better planning because the activities are linked to a detailed understanding of how change actually happens (CTC, 2016; Rockwell & Bennett, 2004). It also enhances program evaluation as it allows educators to measure progress towards the achievement of longer-term goals that stretch beyond the identification of program outputs (CTC, 2016; Rockwell & Bennett, 2004; Wiggins & McTighe, 2005).

In utilizing the backwards mapping approach, it is important to consider Bennett’s Hierarchy that outlines various outcome levels that connect the program activities to the intended long-term goals. Table 1 demonstrates the type of outcomes included in the hierarchy that may be immediate, intermediate or long-term in nature (Rockwell, 2004).

Table 1

*The outcome types that would be used in a logic model for educational programs*

Immediate	Knowledge, attitudes, skills and aspirations
Intermediate	Behavior change or adoption of best practices
Long-term	Social, economic and environmental conditions

*Note.* Adapted from “Using Logic Models for Program Development” G. Israel, University of Florida Cooperative Extension Electronic Data Information Source AEC360. Adapted with permission.

Rockwell and Bennett (2004) explained that while immediate outcomes occur directly following engagement in a program activity, intermediate outcomes are expected months or years after program implementation followed by long-term outcomes.

While these concepts are important to consider, agricultural educators must have a specific model to follow that provides additional structure to the aforementioned process. An appropriate model for this case is The Targeting Outcomes of Program (TOP) Model. This model represents a framework commonly used in education that integrates the backwards design approach and Bennett’s Hierarchy to focus on outcomes in planning, implementing and evaluating programs (Rockwell & Bennett, 2004). TOP’s hierarchy also integrates program evaluation in the program development process allowing educators to target specific outcomes in program development and then to assess the degree to which the outcome targets are reached (Rockwell & Bennett, 2004).

While TOP can be used as a programming guide for a single organization, it also can be used for collaborative programming when agencies, organizations, or institutions focus on a strategic need area (Rockwell & Bennett, 2004). It promotes an outcomes framework and program priorities that are based on the views of stakeholders including teachers, administrators, program leaders, program participants, advisory groups and educational specialists. Rockwell and Bennett (2004) believed it created a collaborative advantage with the creation of synergy between collaborating organizations.

Finally, logic models provide an effective tool for educators to use within the TOP Model when putting together program plans for the development and evaluation of educational programs (Israel, 2001). In the planning phases, the intended outcomes are integrated into a logic model in the form of impact indicators that theoretically would result in the programmer’s vision of success (Israel, 2001). These impact indicators should be used to develop program objectives



that would guide the overall evaluation framework and associated evaluation tools. When integrating the additional components of a logic model that include process components, the educator is effectively identifying a causal relationship between the program and its intended outcomes otherwise known as the aforementioned program theory of change (Israel, 2001). By organizing the school gardens program in this manner, programs can measure, learn and improve based on intended outcomes and make proactive changes based on the deficiencies along the outcome chain.

### **Purpose and Objective**

The purpose of the study was to demonstrate the use of a framework for program development and evaluation that stakeholders, including agricultural educators, can adopt in order to show program outcomes. It did so by using an innovative tool, the Delphi technique, which a breadth of stakeholders can adopt. The objective of the study was to identify the most meaningful outcomes (short-term, medium-term, and long-term) that could be included in a program logic model and be utilized to measure the success of such programs. While school garden programs are diverse in size and populations served, this study aims to develop a comprehensive set of indicators that represent multiple types of stakeholders across Florida and integrates divergent needs into a single framework.

### **Methods**

This statewide study used the Delphi technique to identify key outcomes that should be incorporated in evaluation frameworks across a variety of school garden programs. The Delphi technique is frequently used in the educational context to develop consensus for program priorities and objectives that can help guide planning and evaluation efforts of programs (Warner, 2015). The population for this study consisted of key school garden experts that held various roles in school garden programs across the state of Florida. In selecting the expert panel members, an advisory committee was developed that included representatives from state agencies, non-profits, institutions of higher education and various school systems. The advisory committee utilized a selection framework that was predicated on including a breadth of experience, expertise and perspectives that stemmed from criteria that included years of experience, role(s) within the program, organization type and geographic area.

The advisory committee provided a total of 101 unduplicated nominees. From this list, all potential participants were contacted by the principal investigator via email or telephone to setup a scheduled phone call to provide additional information on the study and solicit their inclusion. Of the 101 potential study participants, 76 responded to initial communication. We chose to solicit a large panel of experts to include in this study to develop a comprehensive research product that integrates the breadth of expertise and roles, organizations, and geographic areas that effectively represents the network of key stakeholders and programs in the state. Only two of the 76 that were reached declined to participate in the study. Those that chose to participate received a copy of the initial question included in the first survey to provide time for thoughtful response.

### **Data Collection and Analysis**

The study used a series of three online surveys, each administered following analysis of the previous survey. All 74 panel members were expected to participate in each round but non-

participation did not result in their elimination from the study. The first round of the study used a survey with the open-ended item:

“Please list all of the outcomes that result from a successful school gardens program. Make sure to consider short-term outcomes (changes in knowledge, attitudes, skills and aspirations), medium-term outcomes (behavioral change/adoption of practices) and long-term impacts (societal, economic and environmental) when developing this list.”

This item was used to facilitate the development of a comprehensive list of program outcomes based on the panel’s experience with school garden programs. In each round of the survey, we asked the respondents to provide demographic information about themselves. This included information regarding the organization type that they represent, the role(s) they hold with the garden or garden program, the geographic region where their work takes place and the number of years of experience they have working with school gardens. To delineate geographic area, we utilized the Florida Extension districts. Both geographic region and roles were multiple response items, so each respondent could provide multiple responses based on their work.

We used a three-step process of analysis to categorize the items provided for the development of the second-round survey. First, the data were assessed line by line and coded with temporary names, then recoded until categories became well-defined. Then the individual categories were examined to create meaningful relationships with other categories and subcategories. We then applied the logic model framework to organize the themes within the immediate, intermediate or long-term outcomes. Group coding was used throughout this process where we coded together to develop the initial themes that were then disseminated to an external member for review and feedback (Blair, 2015).

In the second survey, respondents were asked to rate items identified in round one on a seven-point Likert-type scale (1 = *Strongly Agree*, 2 = *Agree*, 3 = *Somewhat Agree*, 4 = *Neither Agree nor Disagree*, 5 = *Somewhat Disagree*, 6 = *Disagree*, 7 = *Strongly Disagree*). The respondents were asked to frame their level of agreement based on how meaningful they felt it was to include such outcomes in the evaluation of a school garden program to ensure its success. Respondents were also asked to consider feasibility to ensure that school garden educators and other key stakeholders would have the capacity to evaluate such outcomes. The researchers adopted the criteria of at least two-thirds level of the group members identifying strongly agree or agree *a priori* as the common definition of consensus and inclusion into the third survey (Boyd, 2003; Conner et al., 2013; Harder et al., 2010; Shinn et al., 2009).

The third and final survey asked the respondents to identify their level of agreement on the same Likert-type scale with the shortened list of outcomes that achieved consensus in round two. The same definition of consensus was applied to the analysis of round three data. The number of iterations are up to the researchers, and two to four rounds are typically considered appropriate to achieve consensus (Delbecq, Van de Ven, & Gustafson, 1975; Linstone & Turoff, 2002). The design of Delphi studies, including the number of rounds employed, is open to modification by the researchers (Warner, 2015). As the majority of the items achieved consensus following round 3, we decided to conclude the study at this point.

Multiple measures were used to ensure the credibility of the findings in order to promote research quality (Lincoln & Guba, 1985). Surveys were validated using an expert panel of program evaluators, agricultural and horticultural educators, and state school garden coordinators

not included in the study. This panel provided a means for evaluating the content, construct and criterion validity of the surveys (Heal & Twycross, 2015). The instruments were piloted with members of the target audience to ensure it was easy to understand and would produce the intended results of the instrument.

### Breakdown of Respondent Demographics

Overall, across all 3 rounds, the participants in this study averaged 10 years ( $M = 10.23$ ,  $SD = 4.92$ ) of experience working with school garden programs. Table 2 provides a breakdown of the rest of the respondent demographic information per round.

Table 2

*A breakdown of the participant demographics per round of the Delphi study including organization type, role(s) in the garden and geographic area(s) where program takes place*

	Round 1 ( $n = 64$ )	Round 2 ( $n = 56$ )	Round 3 ( $n = 60$ )
	$n$ (%)	$n$ (%)	$n$ (%)
<b>Organization*</b>			
University/Extension	20 (31.3)	18 (34)	18 (30.5)
State Agency	1 (1.6)	1 (1.9)	1 (1.7)
Non-profit	12 (18.8)	9 (17.0)	16 (27.1)
Elementary School	11 (17.2)	10 (18.9)	10 (16.9)
Middle School	5 (7.8)	5 (9.4)	3 (5.1)
High School	1 (1.6)	1 (1.9)	1 (1.7)
School Board/District	5 (7.8)	4 (7.5)	5 (8.5)
Other	9 (14.1)	5 (9.4)	5 (8.5)
<b>Roles</b>			
Administrator	27	18	22
Educator	46	36	35
Professional Development	19	11	10
Garden Team Member	26	12	15
Volunteer	23	10	8
Other	18	10	11
<b>Geographic Area</b>			
Northwest	8	7	8
Northeast	4	5	5
Central	5	6	5
South Central	35	27	29
South	9	5	7
Statewide	3	4	5

*Note.* Both geographic region and roles were multiple response items, so each respondent may have provide multiple response based on their work and the reason percentages are not provided for these data.

\*Denotes the percentage of respondents for each organization type. Percentages are only provided for organization type.

## Results

### Delphi Results by Round

#### Round 1

A total of 327 open-ended responses were collected in round one. After we combined responses with the same meaning, there were seventy-seven types of outcomes identified in the first round that included thirty-four immediate outcomes, twenty-six intermediate outcomes and seventeen long-term outcomes. The response rate for this round was 87% ( $n = 64$ ).

#### Round 2

Fifty-six of the 74 individuals responded in round two for a 76% response rate. In this round, respondents were asked to rate their level of agreement with the 77 outcomes identified in round one on a seven point Likert-type scale related to the importance of inclusion in the evaluation of school garden programs. Consensus was achieved on 47 outcomes, while the other 30 fell below the two-thirds threshold and were eliminated from further study (Table 3).

Table 3

*Summary of the Delphi Study round two results for consensus items showing the percentage of participants that chose strongly agree or agree for the importance of the inclusion of each item in the evaluation of school garden programs.*

Outcomes	Strongly Agree / Agree %
<b>Immediate Outcomes (34)</b>	
Increased knowledge and awareness of where food comes from (foods systems)	92.7
Students exhibit an increased willingness to eat more nutritious foods (i.e. fresh fruits and vegetables)	90.9
Students exhibit increased knowledge about nutrition and understand the importance of eating healthy to promote wellness	87.3
Students exhibit an increase in knowledge of healthy eating habits	87.3
Students demonstrate increased ability to identify various plants and produce (i.e. fruits and vegetables)	85.5
Students demonstrate an increase in knowledge and appreciation for the natural environment	83.6
Increasing knowledge, skills and confidence for planning and carrying out gardening best practices	83.6
Fosters love of gardening among students that increases their enthusiasm for learning	83.3
Increased life skills including leadership, accountability, teamwork/cooperation, social skills, responsibility, focus and patience	80.0
Students demonstrate increased knowledge of the value of a garden	78.2
Increased knowledge and skills through cross curricular integration in topics associated with gardening (i.e. science, technology, engineering math, social sciences, history, language arts, etc.)	74.5
Increased knowledge and skills among teachers for cross-curricular integration at the gardens	74.5

Students demonstrate positive attitudes towards exercise while gardening	70.4
Students demonstrate increased knowledge and appreciation for the hard work associated with gardening	69.1
Students, parents and teachers demonstrate increased knowledge, skills, interest and confidence for growing their own food	69.1
Students exhibit an increase in knowledge and appreciation for the value of local food systems (i.e. local foods, local agriculture, local farmers, etc.)	69.1
Families demonstrate increased awareness and interest in home gardening	69.1
Students and teachers exhibit increased knowledge and awareness of food safety practices	67.3
<b>Intermediate Outcomes (26)</b>	
Adults positively engage with students in the garden	81.8
Students, Parents and Teachers make healthier food choices (i.e. expanding palate, eating more fruits and vegetables, trying new healthy foods/drinks)	81.8
Students are more engaged (participate, listen and pay attention to lesson)	80.0
Students engage in nature through outdoor activities	80.0
Students take home produce for cooking/consumption at home	80.0
Increased parent and community engagement in the garden	80.0
Teachers incorporate nutrition education into garden instruction	78.2
Teachers develop and implement garden-based curriculum that leverages real-world application of multiple disciplines (i.e. math, science, history, etc.) and connects to state standards	76.4
Students and staff share healthier options and lifestyles with others	74.5
Administrators designate the garden as an outdoor classroom to be incorporated in the regular school	72.7
Create a plan and structure to collaboratively manage the gardens	72.7
Students increase their physical activity	72.2
Students will protect their environmental by using sustainable gardening practices (water conservation, composting, re-use of materials, etc.)	69.1
School receive donations from local business	69.1
Students and teachers conduct gardening and food preparation practices in accordance with proper food safety	69.1
Students and teachers encourage family members to garden at home	67.3
<b>Long-term Outcomes (17)</b>	
Increase in the number of school, community and home gardens	87.3
Sustainable school gardens (sustained for multiple years)	83.6
Increased access to fresh fruits and vegetables	83.3
Improved quality of outdoor school environment	83.3
Students and teachers become environmental stewards	78.2
Increase in the number of partnerships for school gardens	78.2
Students are connected to nature and their food	74.1
Complete school program that provides a continuum of education from elementary through post-secondary	74.1
A productive edible garden that provides produce for students to bring home	72.7
Future generations participate in sustainable agricultural practices	70.9
Healthier garden participants (physical and mental health)	70.9

---

The outcomes with the highest level of agreement in the immediate outcomes range centered on food systems, nutrition and wellness, horticulture and attitudes toward gardening, and the natural environment. The outcomes with the highest level of agreement in the medium-term range were predominately focused on students sharing knowledge about gardening, parents and community members engaging in gardening with youth, making healthier food choices, engagement with instruction and engagement in outdoor activities. The outcomes with the highest level of agreement in the long-term outcomes range included an increase in the total number of gardens (school, community and backyard), increased sustainability of the gardens, increased healthy food access, improved quality of outdoor school environment, the increase in environmental stewards and the increase in the number of partnership for school gardens.

Respondents exhibited variance that school gardens should be developed and evaluated based on their ability to increase the agribusiness knowledge and skills of their participants along with increasing their knowledge of larger scale environmental issues. Respondents felt, that in the intermediate, success should not be evaluated based on the gardens ability to be funded to grow food for the lunchroom, its ability to promote increase students' attendance and its ability to create partnerships for the development of a program continuum. Additionally, respondents varied on their perspective that school gardens should be developed and evaluated based on their ability to create larger scale, positive economic and social conditions related to strengthening local economies and providing financial security, creating safer and more resilient communities and creating peace in school.

*Round 3*

In round three, consensus was achieved on 38 of the shortened list of 47 items that fell within the definition of consensus based on the responses from round two (Table 4). Panel members were asked to go through the same exercise as in round two in an attempt to capture any potential changes in perception based on the shortened list. Sixty of the 74 panel members responded in this round for an 81.8% response rate.

Table 4

*Summary of the Delphi Study round three results for consensus items showing the percentage of participants that chose strongly agree or agree for the importance of the inclusion of each item in the evaluation of school garden programs.*

Outcome	Strongly Agree / Agree %
<b>Immediate Outcomes (18)</b>	
Increased knowledge and awareness of where food comes from (foods systems)	94.9
Students exhibit an increase in knowledge of healthy eating habits	86.4
Fosters love of gardening among students that increases their enthusiasm for learning	86.4
Students exhibit increased knowledge about nutrition and understand the importance of eating healthy to promote wellness	84.7
Increased life skills including leadership, accountability, teamwork/cooperation, social skills, responsibility, focus and patience.	84.7
Students exhibit an increased willingness to eat more nutritious foods (i.e. fresh fruits and vegetables)	83.1

Increased knowledge and skills among teachers for cross-curricular integration at the gardens	83.1
Students, parents and teachers demonstrate increased knowledge, skills, interest and confidence for growing their own food.	81.4
Students demonstrate increased ability to identify various plants and produce (i.e. fruits and vegetables)	81.4
Students demonstrate an increase in knowledge and appreciation for the natural environment	81.4
Increasing knowledge, skills and confidence for planning and carrying out gardening best practices	81.4
Students demonstrate increased knowledge of the value of a garden	81.4
Increased knowledge and skills through cross curricular integration in topics associated with gardening (i.e. science, technology, engineering math, social sciences, history, language arts, etc.)	79.7
Students exhibit an increase in knowledge and appreciation for the value of local food systems (i.e. local foods, local agriculture, local farmers, etc.)	69.5
<b>Intermediate Outcomes (17)</b>	
Students engage in nature through outdoor activities	86.4
Students are more engaged (participate, listen and pay attention to lesson)	78.0
Students share knowledge about gardening	76.3
Adults positively engage with students in garden	76.3
Students, parents and teachers make healthier food choices (i.e. expanding palate, eating more fruits and vegetables, trying new healthy foods/drinks)	76.3
Teachers incorporate nutrition education into garden instruction	74.6
Create a plan and structure to collaboratively manage the gardens	74.6
Students will protect their environment by using sustainable gardening practices (water conservation, composting, re-use of materials, etc.)	74.6
Teachers develop and implement garden-based curriculum that leverages real-world application of multiple disciplines (i.e. math, science, history, etc.) that connects to state standards.	72.9
Students increase their physical activity	72.9
Increased parent and community engagement in the garden	72.4
Students take home produce for cooking/consumption at home	71.2
Administrators designate the garden as an outdoor classroom to be incorporated in the regular school	69.5
<b>Long-term Outcomes (12)</b>	
Improved quality of outdoor school environment	83.1
Increased access to fresh fruits and vegetables	79.3
Sustainable school gardens (sustained for multiple years)	78.0
Students are connected to nature and their food	78.0
Healthier garden participants (physical and mental health)	76.3
Increase in the number of school, community and home gardens	74.6
Students and teachers become environmental stewards	74.6
Increase in the number of partnerships for school gardens	74.6
A productive edible garden that provides produce for students to bring home	69.5
Future generations participate in sustainable agricultural practices	69.5

---

Four of the nine outcomes that did not maintain consensus resided in the immediate outcomes range related to awareness and interest for gardening at home, increased knowledge and appreciation for the hard work associated with gardening, positive attitudes towards exercising while gardening and knowledge of food safety practices. An additional four of the nine outcomes that did not maintain consensus resided in the intermediate outcomes range related to the schools receiving donations from local business, utilizing best practices related to food safety, sharing healthier options and lifestyles and encouraging family members to garden at home. Finally, only one of the nine outcomes that did not maintain consensus resided in the long-term range and related to creating the condition where there exists a complete school program that provides a continuum of education from elementary through post-secondary.

### **Conclusion and Implications**

Utilizing the Delphi technique proved to be a useful approach in gaining the input of a diverse panel of key experts in the identification of set of agreed outcomes that are essential to school gardens. The panel reached consensus on 14 immediate outcomes, 13 intermediate outcomes and 11 long-term outcomes. The panel viewed increasing the students' knowledge of food systems, increasing their engagement in nature through outdoor activities and increasing the quality of the outdoor school environment as top priorities for school gardens. Since the panel of experts represented the diversity of stakeholders involved in community gardens across the state, it provided a comprehensive and holistic lens to the Delphi technique that included varied interests, expertise and perspectives.

This process shows how a network of key stakeholders that exist in the context of school gardens can work together to develop an outcome-driven program. In addition, this model provides a basis for identifying a program's performance measures because components that are important enough to include in a logic model should also be the focus for performance measurement (Israel, 2001). It is important to take the results of this study into consideration when planning or refining a school garden program but should not be viewed as a panacea as local needs should be integrated into planning decisions. The results have the potential to inform a comprehensive framework for school garden program development and evaluation that agricultural educators, extension faculty and staff, and other school garden key stakeholders, can adopt and implement to consistently demonstrate positive program outcomes across geographic regions.

Agricultural education professionals and other stakeholders connected to school gardens can use the results of this study to provide a solid foundation for an outcome-driven school garden program. This study provided additional rigor and evidence than can be transferred from a specific case or intervention strategy, by bringing a diverse group of experts to help to inform these efforts across the state of Florida and beyond. Their input can be integrated within backward design approach and help streamline the review process for new school garden educators looking to create their own program, or existing stakeholders looking towards program refinement.

When planning for school garden initiatives, agricultural education professionals and school garden stakeholders should consider the findings of this study. The immediate, intermediate, and long-term outcomes can be used to design the structure of a school garden, formal and informal curriculum for students, and can serve as a guide for school garden evaluation. These outcomes may also be used as framework for grant-seeking activities and to



assist with demonstrating accountability to funders (Rockwell & Bennett, 2004). We recommend those associated with school garden programs consult this list and select the most important and relevant outcomes for their local context and students' needs.

A good starting place in using these findings may be to consider the outcomes that received the highest level of agreement as they are likely to be the most universal among school garden programs. In the short-term, school gardens should increase knowledge of food systems of healthy eating while nurturing a love of gardening among students. Medium-term, school gardens should promote connection to nature, more engaged students, and sharing of gardening information. In the long-term, school gardens should result in better outdoor environments, improved access to healthy produce, and sustained school gardening programs.

This study goes beyond providing desired results that are simply related to learning outcomes and are expanded to include behavior change, adoption of best practices and the creation of long-term conditions. This expansion holds promise for those that intend to achieve far reaching impacts, which is necessary for program accountability and public support (Williams & Dixon, 2013). Integrating the results of this study using the backward design into a program logic model ensures that results may provide a valuable contribution towards an educators' program theory of change (Israel, 2001) and potentially clarify points where evaluation tools are needed in addition to provide additional clarity in the development and selection of instructional strategies (Wiggins & McTighe, 2005).

Agriculture educators have the opportunity to use our results or the results of their own Delphi study to work in collaboration with their support network to outline a corresponding outcomes framework using the logic model (Israel, 2001; Rockwell & Bennett, 2004). Figure 1 provides a basic example of a casual chain of outcomes organized within the logic model and outlined in terms of the backwards design principles of the TOP Model.

Figure 1

*Outcome results of the Delphi study outlined in terms backwards design using Bennett's hierarchy within the TOP Model organized for a program logic model*

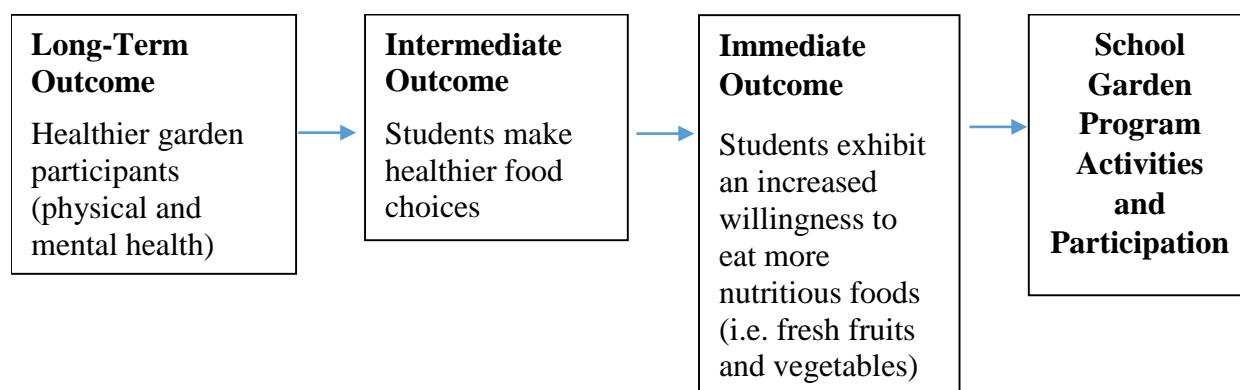

Within the example, the educator's long-term vision for success includes the outcome of developing healthier garden participants. This program theory of change demonstrates that to achieve that long-term outcome, students must make healthier food choices predicated on the program's ability to positively influence their willingness to eat more nutritious foods. Since the results of this study were organized similarly to a logic model, agricultural educators or support

organizations tasked with developing garden activities may better understand how to influence participants' knowledge, attitudes, skills, and aspirations necessary to achieve behavior change or the adoption of best practices (Israel, 2001). While the example in Figure 1 provides the casual chain of outcomes, it is also important to develop a set of associated measurable impact indicators for evaluating program success. Possible impact indicators for the above example may include: lowering body mass index, reducing occurrences of obesity, reducing occurrences of diabetes, and decreased use of related medication to name a few.

With the presented structure, those responsible for evaluating program performance can better understand when to administer evaluative tools and how they should be structured (Israel, 2001). The hierarchy of outcomes not only maps what evaluation should measure but also provides a timeline of expected results to inform appropriate timing for administering evaluation tools. So for instance, the example above outlines an immediate outcome related to increasing the students' willingness to eat more nutritious foods. As a result, agricultural educators need to develop and administer tools directly following student engagement with the related activity to evaluate its ability to achieve the intended outcome. Additionally, follow up instruments or mechanisms would need to be developed to measure intermediate or long-term outcomes that are expected either months or years following implementation. It is important to understand this dynamic to effectively align evaluation with the appropriate timing of outcomes (Israel, 2001). Regardless of whether the agricultural educator is responsible for evaluating these outcomes or a support organization is leading such an effort, it is important that they understand these principles to serve as an effective resource in utilizing evaluation data to make programmatic decisions (Rockwell & Bennett, 2004).

## References

- Bowker, R., & Tearle, P. (2007). Gardening as a learning environment: A study of children's perceptions and understanding of school gardens as part of an international project. *Learning Environments Research, 10*, 83-100. doi:10.1007/s10984-007-9025-0
- Boyd, B. L. (2003). Identifying competencies for volunteer administrators for the coming decade: A national Delphi study. *Journal of Agricultural Education, 44*(4), 47-56. Retrieved from <http://pubs.aged.tamu.edu/jae/pdf/Vol44/44-04-47.pdf>
- Benson, M. C. (2014). Exploring extension involvement in farm to school program activities. *Journal of Extension, 52*(4), 4FEA4. Retrieved from [www.joe.org/joe/2014august/a4.php](http://www.joe.org/joe/2014august/a4.php)
- Berenguer, J. (2007). The effect of empathy in pro-environmental attitudes and behaviors. *Environment and Behavior, 39*, 269-283. doi:10.1177/0013916506292937
- Berezowitz, C. K., Bontrager Yoder, A. B., & Schoeller, D. A. (2015). School gardens enhance academic performance and dietary outcomes in children. *Journal of School Health, 85*(8), 508-518. Retrieved from <http://farmtoschoolbc.ca/wp-content/uploads/sites/3/2016/12/School-Gardens-Enhance-Academic-Performance.pdf>
- Berg, B. L. (2004). *Qualitative research methods* (5th ed.). Boston, MA: Pearson Education, Inc.
- Black, B. J., Haynes, C., Schrock, D., Duerfeldt, K., & Litchfield, R. (2016). Master Gardener-led lessons increase knowledge in gardening and environmental science for Iowa summer camp youth. *Journal of Extension, 54*(5), 5RIB9. Retrieved from [www.joe.org/joe/2016october/rb9.php](http://www.joe.org/joe/2016october/rb9.php)
- Blair, E. 2015. A reflexive exploration of two qualitative data coding techniques. *Journal Methods and Measurement in Social Sciences, 6*(1):14-29. doi:10.2458/v6i1.18772
- Brink, L., & Yost, B. (2004). Transforming inner-city school grounds: Lessons from Learning Landscapes. *Children, Youth and Environments, 14*, 208-232. Retrieved from [http://www.colorado.edu/journals/cye/14\\_1/fieldreports/report3.htm](http://www.colorado.edu/journals/cye/14_1/fieldreports/report3.htm)
- Brunotts, C. M. (1998). *School gardening: A multifaceted learning tool. An evaluation of the Pittsburgh Civic Garden Center's "Neighbors and Schools Gardening Together"* (Master's thesis). Available from Proquest UMI Dissertation Publishing database. (Proquest No. 1392725).
- Canaris, I. (1995). Growing foods for growing minds: Integrating gardening and nutrition education into the total curriculum. *Children's Environments, 12*, 264-270. Retrieved from <http://www.jstor.org/stable/41503435>
- Center for Theory of Change (CTC). (2016). *What is theory of change?* Retrieved from <http://www.theoryofchange.org/what-is-theory-of-change/>

- Conner, N. W., Roberts, T. G., & Harder, A. (2013). Competencies and experiences needed by entry level international agricultural development practitioners. *Journal of International Agricultural and Extension Education*, 20(1), 19 – 32. Retrieved from [https://www.aiaee.org/attachments/article/1503/Conner\\_Roberts\\_20102.pdf](https://www.aiaee.org/attachments/article/1503/Conner_Roberts_20102.pdf)
- Cutter-Mackenzie, A. (2009). Multicultural school gardens: Creating engaging garden spaces in learning about language, culture, and environment. *Canadian Journal of Environmental Education*, 14, 122-135. Retrieved from <http://files.eric.ed.gov/fulltext/EJ842744.pdf>
- Delp, P., Thesen, A., Motiwalla, J., & Seshadri, N. (1977). *Delphi: System tools for project planning*. Columbus, OH: National Center for Research in Vocational Education, Ohio State University.
- Delbecq, A. L., Van de Ven, A. H., & Gustafson, D. H. (1975). *Group techniques for program planning: A guide to nominal group and Delphi processes*. Glenview, Illinois: Scott, Foresman.
- Dirks, A. E., & Orvis, K. (2005). An evaluation of the Junior Master Gardener Program in third grade classrooms. *HortTechnology*, 15, 443-447. Retrieved from <http://horttech.ashspublications.org/content/15/3/443.full.pdf>
- Duncan, D. W., Collins, A., Fuhrman, N. E., Knauft, D. A., & Berle, D. C. (2016). The impacts of a school garden program on urban middle school youth. *Journal of Agricultural Education*, 57(4), 174–185. doi:10.5032/jae.2016.04174
- Dzubak, J., Shaw, A., Strohbehn, C., & Naeve, L. (2016). Food safety education for students and workers in school gardens and university farms. *Journal of Extension*, 54(1), 1TOT7. Retrieved from [www.joe.org/joe/2016february/tt7.php](http://www.joe.org/joe/2016february/tt7.php)
- Feenstra, G., & Ohmart, J. (2012). The evolution of the School Food and Farm to School Movement in the United States: connecting childhood health, farms, and communities. *Childhood Obesity (Formerly Obesity and Weight Management)*, 8(4), 280-289. doi:10.1089/chi.2012.0023
- Graves, L. A., Hughes, H., & Balgopal, M. M. (2016). Teaching STEM through horticulture: implementing an edible plant curriculum at a STEM-centric elementary school. *Journal of Agricultural Education*, 57(3), 192–207. doi:10.5032/jae.2016.03192
- Harder, A., Place, N. T., & Scheer, S. D. (2010). Towards a competency-based extension education curriculum: A Delphi study. *Journal of Agricultural Education*, 51(3), 44–52. doi:10.5032/jae.2010.03044
- Hayden-Smith, R. (2006). *Soldiers of the soil: A historical review of the United States school garden army*. Davis, CA: University of California, 4-H Center for Youth Development. Retrieved from <http://ucanr.edu/sites/thevictorygrower/files/101531.pdf>
- Heale, R., & Twycross, A. (2015). Validity and reliability in quantitative studies. *Evidence-based nursing*, 18(3), 66-67. doi:10.1136/eb-2015-102129

- Hendren, D. K. (1998). *Evaluation of master gardeners' classroom garden project on youth living in low-income, inner-city neighborhoods of San Antonio* (Doctoral dissertation). Available from Proquest UMI Dissertation Publishing database. (Proquest No. 9839567)
- Israel, G. D. (2001). *Using logic models for program development* (No. AEC 360). University of Florida Cooperative Extension Electronic Data Information Source AEC360. Retrieved from <http://edis.ifas.ufl.edu/wc041>
- Koch, S., Waliczek, T. M., & Zajicek, J. M. (2006). The effect of a summer garden program on the nutritional knowledge, attitudes, and behaviors of children. *HortTechnology*, *16* (4), 620-625. Retrieved from <http://horttech.ashspublications.org/content/16/4/620.full.pdf>
- Lincoln, Y. S. & Guba, E. G. (1985). *Naturalistic inquiry*. Newbury Park, CA: Sage.
- Lineberger, S. E., & Zajicek, J. M. (2000). School gardens: Can a hands-on teaching tool affect students' attitudes and behaviors regarding fruit and vegetables? *HortTechnology*, *10*(3), 593-597. Retrieved from <http://horttech.ashspublications.org/content/10/3/593.full.pdf>
- Linston, H. A., & Turoff, M. (Eds.). (2002). *The Delphi method: Techniques and applications* [Electronic version]. Newark, NJ: New Jersey Institute of Technology.
- Mayer-Smith, J., Bartosh, O., & Peterat, L. (2009). Cultivating and reflecting on intergenerational environmental education on the farm. *Canadian Journal of Environmental Education*, *14*, 107-121. Retrieved from <https://cjee.lakeheadu.ca/article/view/890>
- Merriam, S. B. (2009). *Qualitative research: A guide to design and implementation*. San Francisco, CA: Jossey-Bass.
- Morgan, P. J., Warren, J. M., Lubans, D. R., Saunders, K. L., Quick, G. I., & Collins, C. E. (2010). The impact of nutrition education with and without a school garden on knowledge, vegetable intake and preferences and quality of school life among primary-school students. *Public Health Nutrition*, *13*, 1931-1940. doi:10.1017/S1368980010000959
- Morris, J. L., Neustadter, A., & Zidenberg-Cherr, S. (2001). First-grade gardeners more likely to taste vegetables. *California Agriculture*, *55*(1), 43-46. doi:10.3733/ca.v055n01p43
- O' Brien, S. A., & Shoemaker, C. A. (2006). An after-school gardening club to promote fruit and vegetable consumption among fourth grade students: The assessment of social cognitive theory constructs. *HortTechnology*, *16* (1), 24-29. Retrieved from <http://horttech.ashspublications.org/content/16/1/24.full.pdf>
- Parmer, S. M., Salisbury-Glennon, J., Shannon, D., & Struempfer, B. (2009). School gardens: An experiential learning approach for a nutrition education program to increase fruit and vegetable knowledge, preference, and consumption among second-grade students. *Journal of Nutrition Education & Behavior*, *41*, 212-217. doi:10.1016/j.jneb.2008.06.002

- Robinson, C. W., & Zajicek, J. M. (2005). Growing minds: The effect of a one year school garden program on six constructs of life skills of elementary school children. *HortTechnology*, 15(3), 453-457. Retrieved from <http://horttech.ashspublications.org/content/15/3/453.full.pdf>
- Rockwell, K., & Bennett, C. (2004). Targeting outcomes of programs: A hierarchy for targeting outcomes and evaluating their achievement. Retrieved from <http://digitalcommons.unl.edu/cgi/viewcontent.cgi?article=1047&context=aglecfacpub>
- Sheffield, B. K. (1992). *The affective and cognitive effects of an interdisciplinary garden-based curriculum on underachieving elementary students* (Doctoral dissertation). Available from Proquest UMI Dissertation Publishing database. (Proquest No. 9224935)
- Shinn, G. C., Wingenbach, G. J., Briers, G. E., Lindner, J. R., & Baker, M. (2009). Forecasting doctoral-level content in international agricultural and extension education—2010: Viewpoint of fifteen engaged scholars. *Journal of International Agricultural and Extension Education*, 16(1), 57–71. doi:10.5191/jiaee.2009.16105
- Simone, M. F. (2003). *Back to the basics: Student achievement and schoolyard naturalization* (Unpublished master's thesis). Trent University, Ontario, Canada.
- Skelly, S. M., & Zajicek, J. M. (1998). The effect of an interdisciplinary garden program on the environmental attitudes of elementary school students. *HortTechnology*, 8(4), 579-583. Retrieved from <http://horttech.ashspublications.org/content/8/4/579.full.pdf>
- Slavin, R. E. (2008). Perspectives on evidence-based research in education—What works? Issues in synthesizing educational program evaluations. *Educational researcher*, 37(1), 5-14. doi:10.3102/0013189X08314117
- Smithsonian Gardens. (2017) *Grown from the Past: A Short History of Community Gardening in the United States*. Retrieved from <https://communityofgardens.si.edu/exhibits/show/historycommunitygardens/schoolgardens>
- Stufflebeam, D. L., McCormick, C. H., Brinkerhoff, R. O., & Nelson, C. O. (2012). *Conducting educational needs assessments*. Berlin, Germany: Springer Science & Business Media.
- Waliczek, T. M., & Zajicek, J. M. (1999). School gardening: Improving environmental attitudes of children through hands-on learning. *Journal of Environmental Horticulture*, 17(4), 180-184. Retrieved from <http://www.hrijournal.org/doi/pdf/10.24266/0738-2898-17.4.180>
- Warner, L. A. (2015). *Using the Delphi technique to achieve consensus: A tool for guiding extension programs*. University of Florida Cooperative Extension Electronic Data Information Source AEC521. Retrieved from <http://edis.ifas.ufl.edu/wc183>
- Wiggins, G. & McTighe, J. (2005). *Understanding by design*. Alexandria, Virginia: Association for Supervision and Curriculum Development.

Williams, D. R., & Dixon, P. S. (2013). Impact of garden-based learning on academic outcomes in schools: Synthesis of research between 1990 and 2010. *Review of Educational Research*, 83(2), 211-235. doi:10.3102/0034654313475824

## **Laboratory Management Needs of Iowa School-Based Agricultural Mechanics Teachers**

A. Preston Byrd, Ph.D., Clemson University  
P. Ryan Saucier, Ph.D., Sam Houston State University  
Ryan G. Anderson, Ph.D., Sauk Valley Community College

### **Abstract**

Further investigation is needed to determine the specific laboratory management needs of agricultural education teachers. The theoretical foundation that guided this study was Bandura's theory of self-efficacy (1997). To further align this theory with this study researchers explored the beliefs and one's capabilities to organize and execute the course of action to manage an agricultural mechanics laboratory. The research objectives for this study were: Determine the self-perceived level(s) of importance and ability as related to agricultural mechanics laboratory management competencies and determine the professional development needs of Iowa school-based agricultural education teachers regarding agricultural mechanics laboratory management competencies. Results of the Mean Weighted Discrepancy Scores (MWDS) indicated that teacher's greatest in-service needs revolved around hazardous laboratory conditions and materials. The competencies that ranked the highest included correcting hazardous laboratory conditions, safely disposing of hazardous materials, properly installing and maintaining safety devices and emergency equipment, safely handling hazardous materials, and safely storing hazardous materials. Agricultural education teachers need professional development in the realm of hazardous conditions within the confines of an agricultural mechanics laboratory and handling hazardous materials. Working with hazardous materials is a critical competency that agricultural educators must have when managing any type of laboratory.

### **Introduction**

Agricultural laboratories offer a unique opportunity for agricultural education teachers to expose students to hands-on activities that reinforce both academic and vocational skills (Hubert, Ullrich, Lindner, & Murphy, 2003). The various agricultural laboratories that teachers utilize can include the study of curriculum related to land, animals, greenhouse crops, forestry, aquaponics, and agricultural mechanics. McKim and Saucier (2011) stated that an agricultural mechanics laboratory is a necessary component of a quality agricultural education program. The incorporation of laboratory-based experiences allow students the opportunity to apply scientific inquiry and STEM-based applications (Osborne & Dyer, 2000). Since students learn various psychomotor skills in agricultural mechanics curriculum, a lot of time is spent inside an agricultural mechanics laboratory (Johnson, Schumacher, & Stewart, 1990; McKim & Saucier, 2011).

According to numerous studies, laboratory management is the most important aspect of teaching in any agricultural education laboratory (Blackburn, Robinson, & Field, 2015; Johnson et al., 1990; McKim & Saucier, 2011; Saucier, Terry, & Schumacher, 2009; Saucier & McKim, 2011). Agricultural education teachers must be able to complete various tasks when managing a laboratory such as maintaining a safe working environment, providing safety instruction, and identifying safety hazards (Phipps, Osborne, Dyer, & Ball, 2008). Harper (1984) posited that



students are more conscious of safety practices when the teacher exhibits safe behavior and follows proper safety procedures. Having and maintaining positive safety beliefs and procedures are crucial in order to enhance learning opportunities for students in agricultural laboratories (Hubert et al., 2003).

Bruening, Hoover, and Radhakrishna (1991) stated that the physical safety of students must come first, out of all the other duties that an agricultural education teacher has, when teaching students in a laboratory. Since students tend to live in a risk-taking world with disregard towards rules, they are more apt not to know and understand the consequences of unsafe behaviors (Hubert et al., 2003). Saucier, Vincent, and Anderson (2014) posited that agricultural education teachers must be competent and knowledgeable in laboratory management in order to establish a safe learning environment in agricultural laboratories for their students.

If a teacher is incompetent and unknowledgeable in regards to laboratory management, an agricultural laboratory can quickly become unsafe and/or unused (Hubert et al., 2003). According to Hubert, et al., (2003), incompetence of laboratory management could stem from inadequate instruction in pre-service preparation programs. McKim and Saucier (2013) found over a 20 year period that agricultural education instructors were receiving less training in agricultural mechanics, students had less working space in agricultural mechanics laboratories, and programs had an increased student enrollment. Furthermore, Dyer and Andreasen (1999) stated that new agricultural education teachers were ill-equipped in safety. With a decline in required agricultural mechanics courses in pre-service programs, perhaps more in-service professional development opportunities should be held in order for beginning agricultural education teachers to become competent?

Past studies have stated that strategies are needed to help ensure that pre-service and in-service teachers develop technical competence in regards to laboratory management (Blackburn et al., 2015; Johnson et al., 1990; McKim & Saucier, 2011; Saucier et al., 2009; Saucier & McKim, 2011). Hubert et al. (2003) stated that first year teachers and teachers with minimal experience were more open to receive help in regards to agricultural education program safety concerns. With an increased frequency of professional development opportunities offered to beginning teachers, retention rates among these individuals in the agricultural education field should increase (Ruhland & Bremer, 2002). By determining the laboratory management in-service needs of agricultural education teachers, professional development opportunities can be more efficient and effective. This will help ensure beginning and in-service teachers are more competent and knowledgeable about creating safe learning environments in agricultural education laboratories.

### **Theoretical Framework**

The theoretical foundation that guided this study was Bandura's theory of self-efficacy (1997). Bandura defined self-efficacy as the "beliefs in one's capabilities to organize and execute the course of action required to produce given attainments" (p. 3). Self-efficacy influences a person's choices, actions, the amount of effort they give, how long they persevere when faced with obstacles, their resilience, their thought patterns and emotional reactions, and the level of achievement they ultimately attain (Bandura, 1986). To further align the theory with

this study, researchers explored the beliefs and one's capabilities to organize and execute the course of action to manage an agricultural mechanics laboratory.

### **Purpose and Research Objectives**

The purpose of this study was to describe the laboratory management professional development needs of agricultural education teachers in Iowa who instruct students in an agricultural mechanics laboratory. The purpose aligns with the National Career and Technical Education Research Agenda (Lambeth, Elliot, & Joerger, 2008) research problem area (RPA) 5: Program Relevance and Effectiveness, specifically relating to research activity (RA) 5.1.3: Professional Development of Teachers; with secondary implications in RA 1.2.2: CTE Teacher Education. This research also aligns with Research Priority 3 of the American Association for Agricultural Education (AAAE) national standards for teacher-education in agriculture, which suggests that teacher candidates need to be competent in science and be prepared for a 21<sup>st</sup> century workforce (Roberts, Harder, & Brashears, 2016). The following research objectives were investigated to accomplish this purpose:

1. Identify the personal, professional, and program demographic characteristics of Iowa school-based agricultural education teachers who utilize an agricultural mechanics laboratory to instruct related courses.
2. Determine the self-perceived level of importance that Iowa school-based agricultural education teachers place upon selected agricultural mechanics laboratory management competencies.
3. Determine the self-perceived ability level that Iowa school-based agricultural education teachers place upon selected agricultural mechanics laboratory management competencies.
4. Determine the professional development needs of Iowa school-based agricultural education teachers for selected agricultural mechanics laboratory management competencies.

### **Procedures**

The population for this quantitative study was school-based agricultural education teachers in Iowa who taught agricultural mechanics courses in a laboratory setting during the spring of 2014. Due to the number of subjects ( $N = 238$ ) and access to teacher's email addresses, a random sample was selected from a frame of the state's agricultural education teachers and a representative sample size was selected ( $n = 148$ ) based on recommendations from Krejcie and Morgan (1970).

In 2012, McKim and Saucier analyzed data collected with an instrument (modified by Saucier et. al, 2009) that was used in similar studies conducted in six states (Arkansas, Kentucky, Missouri, Oklahoma, Tennessee, and Wyoming). Furthermore, these researchers used factor analysis and psychometric meta-analysis techniques to "analyze the intercorrelations among

three or more measures that reduce the set to a smaller number of underlying factors" and "to investigate the relationship between the same variables" (Ary, Jacobs, & Sorensen, 2010, p. 642 & 645). From their analysis, only 33 agricultural mechanics laboratory management competencies proved to not have issues with multicollinearity. Furthermore, McKim and Saucier (2012) utilized the 33 competencies and analyzed them using psychometric meta-analysis techniques that divided these competencies into eight constructs.

The data collection instrument modified by McKim and Saucier (2012), was used for data collection in this study. This two-section instrument consisted of 33 statements with double-matrix response scales. One scale was designed to rate the perceived importance of each skill competency (1 = *No Importance*, 2 = *Below Average Importance*, 3 = *Average Importance*, 4 = *Above Average Importance*, 5 = *Utmost Importance*), while the other scale was designed to rate the individual's ability to perform the skill competency (1 = *No Ability*, 2 = *Below Average Ability*, 3 = *Average Ability*, 4 = *Above Average Ability*, 5 = *Exceptional Ability*). The second section of the instrument was used to identify personal, professional, and program characteristics of the respondents and the agricultural education programs where they taught.

The design and format of the data collection instrument was guided by the suggestions of Dillman, Smyth, and Christian (2014). To determine face and content validity, the researchers used a panel of experts. The panel of experts ( $N = 5$ ) consisted of one faculty member from a university that specialized in working with Iowa agricultural mechanics teachers, three doctoral graduate students with prior school-based agricultural education teaching experience, and an agricultural education faculty member with expertise in instrument development and research methodology. The instrument was deemed valid through this process.

This study used a modified instrument that was based upon the instrument that was used in studies of school-based secondary agricultural education teachers in six states by Saucier, et al. (2009) and later validated by McKim and Saucier (2012). The Cronbach's alpha for the scales of measurement (Importance and Ability) included in that instrument (Saucier, et. al.) ranged from .87-.90, indicating a high level of confidence in the reliability of the instrument.

Electronic data collection protocol of Dillman et al. (2014) was followed for this study. After five points of contact, a response rate of 48.65% ( $n = 72$ ) was obtained. Non-response error was a relevant concern; therefore, procedures for handling non-respondents were followed as outlined as *Method 1-comparison of early to late respondents* in Lindner, Murphy, and Briers (2001). Therefore, external validity did not threaten the generalizability of the findings of this study to the target population (Lindner, et al., 2001).

Data were analyzed using IBM SPSS Statistics® version 22.0 for Windows™ based computers. In determining the appropriate analysis of the data, the primary guidance was scales of measurement as outlined by Ary, et al., (2010). The first research objective sought to describe selected personal and professional characteristics of school-based agricultural mechanics teachers in Iowa; thus, frequencies and percentages were calculated for gender, first aid training certified, first responder training certified, and type of teacher certification program completed. Mean, range, and standard deviations were calculated for years of teaching experience, years of agricultural mechanics teaching experience, age, average hours per week spent teaching and

supervising student Supervised Agricultural Experience (SAE) projects, and university semester credit hours completed in agricultural mechanics courses. Additionally, this objective sought to describe selected characteristics of agricultural education programs in Iowa that offered agricultural mechanics courses. Mean, range, and standard deviations were also calculated for the following characteristics: annual student enrollment for agricultural mechanics courses, average student enrollment per agricultural mechanics course, age of agricultural mechanics laboratory, size of the agricultural mechanics laboratory, total budget for the agricultural education program, total budget for agricultural mechanics consumables, total budget for personal protection equipment used in the agricultural mechanics laboratory, and total budget for tools and equipment for the agricultural mechanics laboratory. Additionally, frequency and percentage were calculated in regard to if students were required to pass a safety exam prior to working in the agricultural mechanics laboratory.

The second research objective sought to describe the perceived importance of selected agricultural mechanics laboratory management competencies by school-based agricultural mechanics teachers while the third research objective sought to describe school-based agricultural mechanics teachers' perceived ability to perform selected agricultural mechanics laboratory management competencies. Mean and standard deviations were calculated for all variables associated with these objectives.

The fourth research objective sought to prioritize the agricultural mechanics laboratory management competencies that needed improvement through professional development, as perceived by school-based agricultural mechanics teachers in Iowa. To determine the professional development needs of the respondents, the Borich (1980) needs assessment model was utilized to determine the discrepancy (importance level and ability level) for each competency. In accordance with this model, a Mean Weighted Discrepancy Score (MWDS) was calculated for each competency using the following formula:

$$\text{MWDS} = \frac{(\text{Importance Rating} - \text{Ability Rating}) \times (M \text{ Importance Rating})}{\text{Number of Observations}}$$

A large MWDS represents greater in-service needs, while smaller scores represent lesser in-service needs (Borich, 1980).

## **Findings**

### **Research Objective One**

The average respondent was 40 ( $M = 40.48$ ;  $SD = 12.83$ ) years of age, had taught school-based agricultural education courses for more than 15 years ( $M = 15.22$ ;  $SD = 12.06$ ), and had specifically taught agricultural mechanics courses for 14 years ( $M = 14.00$ ;  $SD = 12.16$ ). On average, the respondents completed six university semester credit hours of agricultural mechanics coursework ( $M = 6.78$ ;  $SD = 7.63$ ) as a part of their bachelor's degree. Additionally, teachers reported that they supervised student work in the agricultural mechanics laboratory for an average rate of more than 7 hours ( $M = 7.42$ ;  $SD = 5.02$ ) per week (see Table 1).

Table 1

*Selected Personal and Professional Demographics of School-based Agricultural Education Teachers in Iowa (n = 72)*

Characteristic	<i>M</i>	<i>SD</i>	Min	Max
Age	40.48	12.83	22.0	74.0
Years of agricultural education teaching experience	15.22	12.06	0.5	42.0
Years of agricultural mechanics teaching experience	14.00	12.16	0.0	42.0
University semester credit hours earned in agricultural mechanics coursework	6.78	7.63	0.0	30.0
Hours spent supervising student work in the agricultural mechanics laboratory weekly	7.43	5.02	0.0	23.0

To further describe the population, a summary of selected personal and professional demographic characteristics of Iowa school-based agricultural education teachers were identified. The respondents consisted of 49 (68.1%) male and 17 (23.6%) female teachers; six teachers failed to indicate their gender ( $f = 8.3\%$ ). As outlined in Table 2, the majority ( $f = 65$ ; 90.3%) of these teachers indicated that they were certified to teach agricultural education through a traditional university teacher education program. Only one teacher indicated that they were certified to teach through an alternative education program ( $f = 1$ ; 1.4%) and six teachers failed to respond to the question ( $f = 6$ ; 8.3%). Almost three quarters of the respondents ( $f = 53$ ; 73.6%) indicated that they received first aid training whereas less than a fifth of the teachers ( $f = 13$ ; 18.1%) indicated receiving first responder training.

Table 2

*Selected Professional Demographics of School-based Agricultural Education Teachers in Iowa (n = 72)*

Characteristic	<i>f</i>	%
Type of teacher certification program completed		
Traditional	65	90.3
Alternative	1	1.4
Missing	6	8.3
Completed first aid training?		
Yes	53	73.6
No	12	16.7
Missing	7	9.7
Completed first responder training?		
Yes	13	18.1
No	52	72.2
Missing	7	9.7

The average annual student enrollment for all agricultural mechanics courses per program was 37 students per year ( $M = 37.30$ ;  $SD = 30.07$ ). Respondents indicated that the average student enrollment in their agricultural mechanics classes was more than 13 students ( $M = 13.40$ ;  $SD = 5.08$ ). Teachers also reported that the average age of the agricultural mechanics laboratory

was slightly more than 35 years of age ( $M = 35.68$ ;  $SD = 16.20$ ) and was 2,404 square feet ( $ft^2$ ) in size ( $M = 2,404.73$   $ft^2$ ;  $SD = 1,916.77$   $ft^2$ ). When considering the total number of students enrolled in all agricultural mechanics courses and the size of the agricultural mechanics laboratory ( $ft^2$ ), each student was provided with 202.32  $ft^2$  ( $SD = 167.45$   $ft^2$ ) of laboratory workspace. The average total budget for an agricultural education program in Iowa during the 2013-2014 academic school year was \$1,806.12 ( $SD = \$1,672.56$ ). The average budget for agricultural mechanics related consumables was \$945.24 ( $SD = \$1,200.80$ ). Furthermore, the average budgets for personal protection equipment was \$199.52 ( $SD = \$340.87$ ) and tools and equipment was \$609.13 ( $SD = \$1,146.17$ ). Therefore, the average consumable budget spent per student in an Iowa agricultural mechanics program was \$41.68 ( $SD = \$63.15$ ), the average budget spent for agricultural mechanics related personal protection equipment per student was \$6.45 ( $SD = \$9.77$ ), and the average budget spent for tools and equipment per student was \$18.17 ( $SD = \$32.81$ ). Additionally, the majority of teachers ( $f = 53$ ; 73.6%) indicated that they require students to pass a safety exam prior to working in the agricultural mechanics laboratory. See Table 3 for a summary of these data.

Table 3  
*Selected Program Demographics of School-based Agricultural Education Programs in Iowa (n = 72)*

Characteristic	<i>M</i>	<i>SD</i>	Min	Max
Average student enrollment in agricultural mechanics courses	13.40	5.08	0.00	26.00
Total student enrollment in agricultural mechanics courses	37.68	30.07	0.00	125.00
Size of agricultural mechanics laboratory ( $ft^2$ )	2,404.73	1,916.77	0.00	10,800.00
Size of agricultural mechanics laboratory work space per student ( $ft^2$ )	202.32	167.45	5.56	900.00
Age of the agricultural mechanics laboratory	35.68	16.20	1.00	65.00
Agricultural mechanics consumable budget (\$)	945.24	1,200.80	0.00	7,500.00
Agricultural mechanics consumable budget (\$ per student)	41.68	63.15	0.00	316.67
Agricultural mechanics Personal Protection Equipment (PPE) budget (\$)	199.52	340.87	0.00	1,900.00
Agricultural mechanics Personal Protection Equipment (PPE) budget (\$ per student)	6.45	9.77	0.00	40.00
Agricultural mechanics Tool and Equipment budget (\$)	609.13	1,146.17	0.00	8,000.00
Agricultural mechanics Tool and Equipment budget (\$ per student)	18.17	32.81	0.00	216.22

### Research Objective(s) Two, Three, and Four

Research objective two sought to describe Iowa school-based agricultural education teachers' perceived levels of importance of selected competencies of agricultural mechanics laboratory management. *Enforcing a student discipline policy* ( $M = 4.61$ ;  $SD = 0.58$ ), *correcting*

*hazardous laboratory conditions* ( $M = 4.61$ ;  $SD = 0.62$ ), and *maintaining a student discipline policy* ( $M = 4.58$ ;  $SD = 0.61$ ) were perceived to be the three competencies with the highest levels of importance by the respondents. The three competencies that were perceived to have the lowest importance were: *planning an agricultural mechanics public relations program* ( $M = 3.03$ ;  $SD = 0.94$ ), *conducting an agricultural mechanics public relations program* ( $M = 3.06$ ;  $SD = 0.98$ ), and *planning student recruitment activities for the agricultural mechanics program* ( $M = 3.31$ ;  $SD = 0.86$ ). The mean level of importance that respondents placed upon the 33 laboratory management competencies was 3.94 ( $SD = 0.42$ ), or average importance of the construct, and the mean level of importance for each competency ranged from 3.03 to 4.61. (see Table 4)

Research objective three sought to describe teachers' perceived ability to perform selected agricultural mechanics laboratory management competencies. Mean values of school-based Iowa agricultural mechanics teachers' perceived ability to perform selected laboratory management competencies ranged from 2.89 to 4.12 with a mean construct of 3.52 ( $SD = 0.47$ ). *Enforcing a student discipline policy* ( $M = 4.12$ ;  $SD = 0.67$ ), *maintaining a student discipline policy* ( $M = 4.02$ ;  $SD = 0.73$ ), and *developing a student discipline policy* ( $M = 3.97$ ;  $SD = 0.76$ ) were perceived to be the three competencies with the highest ability levels of performance by the respondents. The three competencies that respondents perceived to have the lowest ability to perform were: *planning student recruitment activities for the agricultural mechanics program* ( $M = 2.89$ ;  $SD = 0.83$ ), *conducting an agricultural mechanics public relations program* ( $M = 2.97$ ;  $SD = 0.85$ ), and *installing stationary power equipment* ( $M = 3.16$ ;  $SD = 0.91$ ). Please see Table 4 for a summary of the results.

Research objective four sought to determine the professional development needs of Iowa school-based agricultural education teachers for selected agricultural mechanics laboratory management competencies. The top three competencies, based on MWDS, were *correcting hazardous laboratory conditions* (MWDS = 5.00), *safely disposing of hazardous material* (MWDS = 4.39), and *properly installing and maintaining safety devices and emergency equipment* (MWDS = 4.31). The bottom three competencies, based on MWDS, were *maintaining computer based student academic records* (MWDS = -0.22), *planning student recruitment activities for the agricultural mechanics program* (MWDS = 0.15), and *maintaining a file of educational projects/ activities for students* (MWDS = 0.26). Please view Table 4 for a detailed summary of the results.

Table 4

*Agricultural Mechanics Laboratory Management Needs of Iowa School-Based Agricultural Mechanics Teachers (n = 72)*

Rank	Competency	MWDS	Mean Importance Level	SD	Mean Ability Level	SD
1	Correcting hazardous laboratory conditions	5.00	4.61	0.62	3.53	0.87
2	Safely disposing of hazardous materials	4.39	4.33	0.84	3.32	0.90
3	Properly installing and maintaining safety devices and emergency equipment	4.31	4.43	0.65	3.46	0.89
4	Safely handling hazardous materials	3.91	4.48	0.73	3.61	0.85
5	Safely storing hazardous materials	2.92	4.29	0.78	3.61	0.81
6	Maintaining protective equipment for student use	2.73	4.50	0.61	3.89	0.75
7	Performing routine maintenance of agricultural mechanics lab equipment	2.67	4.16	0.69	3.52	0.86
8	Maintaining a student discipline policy	2.57	4.58	0.61	4.02	0.73
9	Selecting protective equipment for student use	2.37	4.47	0.66	3.94	0.74
10	Enforcing a student discipline policy	2.23	4.61	0.58	4.12	0.67
11	Developing a student discipline policy	2.16	4.45	0.66	3.97	0.76
12	Making minor repairs to the agricultural mechanics laboratory facility	2.12	4.13	0.79	3.61	0.83
13	Identifying equipment required to teach agricultural mechanics skills	1.85	4.08	0.69	3.62	0.86
14	Identifying tools required to teach agricultural mechanics skills	1.81	4.12	0.71	3.68	0.83
15	Making minor agricultural mechanics lab equipment repairs	1.67	3.91	0.71	3.49	0.89
16	Promoting laboratory safety by color coding equipment/marketing safety zones/posting appropriate safety signs and warnings	1.40	3.70	0.93	3.32	0.95
17	Installing stationary power equipment	1.36	3.54	0.87	3.16	0.91
18	Identifying supplies required to teach agricultural mechanics skills	1.28	4.02	0.67	3.70	0.78
19	Developing an agricultural mechanics laboratory budget	1.23	3.86	0.91	3.55	1.03
20	Operating within the constraints of an agricultural mechanics budget	1.07	3.91	0.87	3.64	0.99
21	Storing protective equipment for student use	0.99	4.08	0.81	3.83	0.67
22	Developing objective criteria for evaluation of student projects/activities	0.91	3.76	0.66	3.52	0.73
23	Estimating time required for students to complete projects/activities	0.88	3.62	0.76	3.38	0.76
24	Developing a file of educational projects/activities for students	0.80	3.65	0.88	3.43	0.70
25	Utilizing technical manuals to order replacement/repair parts for agricultural mechanics lab equipment	0.66	3.72	0.81	3.54	0.72

(continues)



Table 4 (continued)

*Agricultural Mechanics Laboratory Management Needs of Iowa School-Based Agricultural Mechanics Teachers (n = 72)*

Rank	Competency	MWDS	Mean Importance Level	SD	Mean Ability Level	SD
26	Selecting current references/technical manuals	0.50	3.34	0.77	3.19	0.68
27	Identifying current references/technical manuals	0.45	3.37	0.76	3.24	0.68
28	Planning an agricultural mechanics public relations program	0.41	3.03	0.94	2.89	0.83
29	Implementing student recruitment activities for the agricultural mechanics program	0.36	3.40	0.87	3.30	0.74
30	Conducting an agricultural mechanics public relations program	0.27	3.06	0.98	2.97	0.85
31	Maintaining a file of educational projects/activities for students	0.26	3.54	0.82	3.47	0.72
32	Planning student recruitment activities for the agricultural mechanics program	0.15	3.31	0.86	3.27	0.73
33	Maintaining computer based student academic records	-0.22	3.67	0.83	3.73	0.78

*Note:* Importance Scale: 1 = *No Importance*, 2 = *Below Average Importance*, 3 = *Average Importance*, 4 = *Above Average*

*Importance*, 5 = *Utmost Importance*; Ability Scale: 1 = *No Ability*, 2 = *Below Average Ability*, 3 = *Average Ability*, 4 = *Above Average Ability*, 5 = *Exceptional Ability*.

### **Conclusions, Implications, & Recommendations**

The purpose of this study was to determine the self-perceived level of importance, ability and professional development needs of Iowa secondary agricultural education teachers in regard to agricultural mechanics laboratory management. The typical agricultural education teacher in Iowa is approximately 40 years old, has been teaching for 15 years and has spent just under 7.5 hours per week supervising students in an agricultural mechanics laboratory over the past 14 years. Unique data that has implications to agricultural education has emerged from this study. The conclusions, implications, and recommendations will be addressed for each research objective below.

#### **Research Objective One**

The majority of the participants in the study indicated that they had received first aid training; at least 16% of the teachers had not received any training (9.7% did not respond). However, 70% of the teachers had no training as a first responder. It should be noted that a teacher who is not trained in first aid or first response is not an unsafe instructor. However, Bruening et al., (1991) indicated that the physical safety of students must come first, all other duties that an agricultural education teacher has in a laboratory

are secondary. Therefore, first responder training should be conducted for any agricultural education teacher who works in a laboratory where danger is present. While first aid and first responder training should be conducted school-wide, specialized training related to agricultural laboratories should be conducted at the state-level. With the overwhelming majority of participants in Iowa who received a traditional certification, it is possible that the training could be conducted while they are enrolled in their teacher certification programs. Current teachers who lack training in either first aid or first response can work with local emergency management professionals to conduct training within their agricultural mechanics courses preparing both the teachers and their students.

Recommendations for the size of an agricultural mechanics laboratory exist at both the state and national level. Iowa's recommendation for an agricultural mechanics laboratory is 3,200 square feet (The Governor's Council on Agricultural Education, 2000). The national recommendation for an agricultural mechanics laboratory is 120 square feet of floor space per student (Phipps, et al., 2008). The results of this study indicate that the laboratories are 800 square feet below the state recommendations. To further expand on the size of the laboratories in Iowa, Byrd, Anderson, and Paulsen (2015) reported the agricultural mechanics laboratories were over 150 square feet larger in 2015. It is possible that the teachers miscalculated the size of their facility in either of the studies. It is also possible that with the sampling technique implemented, researchers did not collect from the exact same institutions as those sampled in the study by Byrd et al. With the consolidation of small rural schools and new school buildings being constructed on the rise, it is feasible that the new agricultural mechanics laboratories being built are smaller than the old facilities that they are replacing.

The teachers indicated that the students in this study had approximately 200 square feet of space to work in the agricultural mechanics laboratory. The square footage provided to the students is significantly higher than the national recommendation at first glance; however, the national standard is 150 square feet of free space per person. The numbers reported in this study did not take into consideration the amount of free floor space to work, total square footage of the laboratory was the only data collected in regard to the size of the laboratory. However, it is possible that the students are working in areas that exceed the national standard. With class enrollments averaging 13 students in agricultural mechanics courses, it is possible that the teachers in Iowa have followed the suggestions of Saucier, et al., (2014) and have worked with their respective administrators to reduce the number of students in an agricultural mechanics laboratory in an effort to increase student learning and student safety.

Further exploration into the budget that agricultural education teachers are allocated for agricultural mechanics instruction indicates they had received a total budget of approximately \$1,750.00, which includes consumables, tools and equipment, and personal protective equipment. This budget is down by almost \$250.00 from the figures reported by Byrd et al. (2015). This could be a result of funds cut from the program or funds reallocated to other areas within the agricultural education program. What is alarming from the budget is the \$6.45 budget allocated for personal protective equipment. The funds budgeted for PPE barely covers the cost of safety glasses. The cut in funds have led to similar concerns that were expressed by Saucier et al. (2014), will the reduction in funds lead agricultural education teachers to cut out selected safety items or elect to utilize cheaper versions of safety equipment?

One concern that did emerge from the data collected from research objective one was the percentage of teachers who require students to pass a safety exam. Slightly over 73% of the teachers had indicated they required students to pass a safety exam. The teachers are responsible and liable for ensuring a safe environment (i.e. agricultural mechanics laboratory) for students to learn while engaging in experiential learning. While 73% is well beyond a majority, requiring safety exams should be universally required from 100% of students learning in an agricultural mechanics laboratory.

### **Research Objective(s) Two, Three, and Four**

There are a few conclusions that can be drawn from the results of this study. First, agricultural education teachers need professional development in the realm of hazardous materials. Working with hazardous materials is a critical competency that agricultural educators must have when working in any type of laboratory. With the necessity of working with hazardous materials, agricultural educators need opportunities to increase their competency of this skill. Agricultural educators having a low perceived competence and a perception of difficulty will adversely affect a teacher's expectancy of success that can in turn lead to the incorrect behavior when dealing with hazardous materials. One recommendation is to examine if current curriculum being taught in teacher education programs include this competency. Also, state staff and other professional development providers should include this competence in professional development activities which are made available to agricultural education teachers.

Secondly, laboratory maintenance competence is another area in which agricultural educators need more instruction. If an agricultural educator cannot maintain a safe laboratory environment, students can get injured, which could lead to the teacher being dismissed or liable. When an agricultural educator exhibits the incorrect behavior to their students, the wrong behavior becomes more prevalent in the laboratory. Therefore, a proactive stance to providing agricultural education teachers more professional development in this area is paramount. According to Bandura (1997), a change in perceived competence can change the behavior in which the teacher needs to exhibit. It is recommended that professional development opportunities be made available for agricultural education teachers to participate in to increase their competence in numerous areas of agricultural mechanics laboratory management.

Lastly, teachers believe that agricultural mechanics programs do not need recruitment or public relations activities. If recruitment and public relation programs are done correctly, these programs can help enhance the overall agricultural education program by incorporating community support. This lack of importance placed on these competencies may be due to the lack of competence in the agricultural education teacher to instruct agricultural mechanics, therefore, if there is an increase in competence it might lead to a larger importance placed on these competencies. However, this might not be the case, so providing opportunities for agricultural education teachers to come together and develop these competencies is critical.

## References

- Ary, D., Jacobs, L., & Sorensen, C. (2010). Introduction to research in education. (8<sup>th</sup> ed.). Belmont, CA: Wadsworth Cengage Learning.
- Bandura, A. (1986). *Social foundations of thought and action: A social cognitive theory*. Englewood Cliffs, N.J.: Prentice Hall.
- Bandura, A. (1997). *Self-efficacy: The exercise of control*, New York: W.H. Freeman.
- Blackburn, J. J., Robinson, J. S., & Field, H. (2015). Preservice agriculture teachers' perceived level of readiness in an agricultural mechanics course. *Journal of Agricultural Education*, 56(1), 172-187. doi: 10.5032/jae.2015.01172
- Borich, G. D. (1980). A needs assessment model for conducting follow-up studies. *The Journal of Teacher Education*, 31(3), 39-42. doi:10.1177/002248718003100310
- Bruening, T. H., Hoover, T. S., & Radhakrishna, R. B. (1991). *Improving safety practices in agricultural mechanics laboratories*. Proceedings of the 17<sup>th</sup> Annual National Agricultural Education Research Meeting. Los Angeles, CA.
- Byrd, A. P., Anderson, R. G., & Paulsen, T. H. (2015). Does agricultural mechanics laboratory size affect agricultural education teachers' job satisfaction?. *Journal of Agricultural Education*, 56(1), 6-19. doi: 10.5032/jae.2015.01006
- Dillman, D. A., Smyth, J. D., & Christian, L. M. (2014). Internet, phone, mail, and mixed-mode surveys: The Tailored Method. John Wiley & Sons, Hoboken, NJ.
- Dyer, J. E., & Andreasen, R. J. (1999). Safety issues in agricultural education laboratories: A synthesis of research. *Journal of Agricultural Education*, 40(2), 46-52. doi: 10.5032/jae.1999.02046
- Harper, J. G. (1984). *Analysis of selected variables influencing safety attitudes of agricultural mechanics students*. Paper presented at the Central Region Research Conference in Agricultural Education, Chicago, IL.
- Hubert, D., Ullrich, D., Lindner, J., & Murphy, T. (2003). An examination of Texas agriculture teacher safety attitudes based on a personal belief scale from common safety and health practices. *Journal of Agricultural Systems, Technology and Management*, 17, 1-13.
- Johnson, D. M., Schumacher, L. G., & Stewart, B. R. (1990). An analysis of the agricultural mechanics laboratory management inservice needs of Missouri agriculture teachers. *Journal of Agricultural Education*, 31(2), 35-39. doi:10.5032/jae.1990.02035
- Krejcie, R. V. & Morgan, D. W. (1970). Determining sample size for research activities. *Educational and Psychological Measurement*, 30, 607-610. <https://doi.org/10.1177/001316447003000308>
- Lambeth, J. M., Elliot, J., & Joerger, R. M. (2008). The National Career and Technical Education Research Agenda. *Techniques*, 83(7), 52-55.
- Lindner, J. R., Murphy, T. H., & Briers, G. E. (2001). Handling nonresponse in social science research. *Journal of Agricultural Education*, 42(4), 43-52. doi:10.5032/jae.2001.04043

- McKim, B. R., & Saucier, P. R. (2011). Agricultural mechanics laboratory management professional development needs of Wyoming secondary agriculture teachers. *Journal of Agricultural Education*, 52(3), doi: 10.5032/jae.2011.03075
- McKim, B. R., & Saucier, P. R. (2012). A multi-state factor-analytic and psychometric meta-analysis of agricultural mechanics laboratory management competencies. *Journal of Agricultural Education*, 53(2), doi: 10.5032/jae.2012.02139
- McKim, B. R., & Saucier, P. R. (2013). A 20-year comparison of teachers' agricultural mechanics laboratory management competency. *Journal of Agricultural Education*, 54(1), 153-166. doi: 10.5032/jae.2013.01153
- Osborne, E. W., & Dyer, J. E. (2000). Attitudes of Illinois agriscience students and their parents toward agriculture and agricultural education programs. *Journal of Agricultural Education*, 41(3), 50-59. doi: 10.5032/jae.2000.03050
- Phipps, L. J., Osborne, E. W., Dyer, J. E., & Ball, A. L. (2008). *Handbook on agricultural education in public schools* (6<sup>th</sup> ed.). Clifton Park, NY: Thomas Delmar Learning.
- Roberts, T. G., Harder, A., & Brashears, M. T. (Eds.). (2016). *American Association for Agricultural Education national research agenda: 2016-2020*. Gainesville, FL: Department of Agricultural Education and Communication.
- Ruhland, S. K., & Bremer, C. D. (2002). Professional development needs of novice career and technical education teachers. *Journal of Career and Technical Education*, 19(1). Retrieved from <http://scholar.lib.vt.edu/ejournals/JCTE/v19n1/ruhland.html>.
- Saucier, P. R., & McKim, B. R. (2011). Assessing the learning needs of student teachers in Texas regarding management of the agricultural mechanics laboratory: Implications for the professional development of early career teachers in agricultural education. *Journal of Agricultural Education*, 52(4), 24-43. doi: 10.5032/jae.2011.04024
- Saucier, P. R., Terry, Jr. R., & Schumacher, L. G. (2009). Laboratory management in-service needs of Missouri agriculture educators. *Paper presented at the 2009 Southern Region of the American Association for Agriculture Education Conference*, USA, 176-192.
- Saucier, P. R., Vincent, S. K., & Anderson, R. G. (2014). Laboratory safety needs of Kentucky school-based agricultural mechanics teachers. *Journal of Agricultural Education*, 55(2), 184-200. doi: 10.5032/jae.2014.02184
- The Governor's Council on Agricultural Education. (2000). *Guidelines for agricultural education in Iowa secondary schools*. Retrieved from <https://www.google.com/url?sa=t&rct=j&q=&esrc=s&source=web&cd=1&ved=0ahUKEwiF0Zv49ovWAhWCQCYKHR9TDYsQFggmMAA&url=http%3A%2F%2Fiaffa.bizland.com%2Fsitebuildercontent%2Fsitebuilderfiles%2FGuidelinesforQualityHSAgedPrograms.doc&usg=AFQjCNFSVv2l8xsJbRlpXR6EdzEYq0YFEA>

# Exploring the Effect of Personal Norms and Perceived Cost of Water on Conservation

Amanda D. Ali, University of Florida  
Cameron N. Ramey, University of Florida  
Laura A. Warner, University of Florida

## Abstract

In recent studies, between 50% to 75% of residential water was used for outdoor irrigation (Milesi et al., 2012). Additionally, turfgrass lawns are widely used in outdoor landscapes, and are the largest irrigated crop by total area in the United States (Milesi et al., 2005). Consequently, as more American homes utilize turfgrass lawns, outdoor irrigation is expected to increase (Devitt, Carstensen, & Morris, 2008). Thus, increases in outdoor water usage coupled with urbanization pressures water resources and intensifies the need to conserve. This study utilized multiple regression to determine factors affecting urban residents' intent to engage in water conservation. It also evaluated the effect of the Theory of Planned Behavior (TPB) variables on intent to conserve water, then included perceived cost of water, and personal norms as additional factors affecting intent. A total of 1,809 urban residents in the U.S. were surveyed via a researcher-developed questionnaire using non-probability purposive sampling. Findings revealed that both social and personal norms had strong effects on intent to conserve water. It was recommended that social and personal norms be made known to target audiences, and used collectively in extension water conservation programs to promote behavior change.

## Introduction and Literature Review

By 2050, it is predicted there will be over 9 billion people on the planet (United Nations, 2009). This figure is an additional 1.4 billion who will join the current 7.4 billion people already putting stress on global food, water, and energy resources (U.S. Census Bureau, 2017). The United Nations Department of Economic and Social Affairs predicts that the 23% of the global population currently residing in cities (with at least 1 million inhabitants) will rise to 27% by 2030 (United Nations, 2016). Rapid urbanization, compounded by global population growth, will continue to increase water demand, "making it difficult to meet goals for the provision of a safe, affordable, domestic water supply" (Parry, Canziani, Palutikof, Van der Linden, & Hanson, 2007, p. 3.5.1). Additionally, climate change has the capacity to upset current water-use systems by altering the quantity, quality, and temperature of global water resources, thereby disrupting patterns of demand and availability. For example, New York City's Department of Environmental Protection considers the "effect of climate change on turbidity" (Miller & Yates, 2006, p. 49) a significant concern for the city's water supply. Increased turbidity levels in primary city reservoirs requires substantial treatment and monitoring in order to meet legal quality standards (Parry et al., 2007). The disturbance of New York City's water turbidity is but one example of the complex ways in which the influence of climate change, population growth, and urbanization can be measured on local and national scales. Focusing on national trends in water-use can help detangle the complexity of these water-related issues by identifying areas where water-use can be reduced.

Consistent with global population growth projections, the U.S. Census Bureau (2017) predicts that the U.S. population will increase from 325 million to almost 417 million by 2060 (Colby & Ortman, 2015). Despite increasing national population growth, the latest study conducted by the U.S. Geological Survey (USGS) found that water withdrawals in the U.S. decreased by 13% between 2005 and 2010, to an estimated 355 billion gallons per day (Maupin et al., 2010). Freshwater withdrawals in 2010 represented one of the lowest total withdrawals in the U.S. since prior to 1970. This reduction included categories specific to industrial, domestic, and agricultural use (Maupin et al., 2010). The USGS considers improvements to thermoelectric power-plant technology, and the Clean Water Act to be major influences on this trend (Maupin et al., 2010). The USGS also notes the decline in freshwater withdrawals specifically for industrial purposes was likely caused by environmental regulation, limited freshwater resources, and a decline in industrial production (including metal, paper, and chemicals) following the 2008 recession (Maupin et al., 2010). Factors such as urbanization, a changing political climate, economic fluctuations, and climate-related environmental variations have demonstrated potential to influence national water usage in unprecedented ways. For the purpose of this research, further contextualization of water-use in the U.S. will focus specifically on domestic use (indoor and outdoor residential), including lawn irrigation (Maupin et al., 2010).

While many studies analyzing the correlation between climate related factors and irrigation practices have focused on the agricultural industry, fewer have attempted to demonstrate the influence of climate-related factors on irrigation practices specific to residential landscapes. Those that have reported several significant findings for the influence of climate factors on residential water-use behaviors. Most notably, a higher average proportion of water-use for outdoor irrigation has been measured in regions with an arid climate as compared to regions with high precipitation rates (Mayer, 1999). The influence of climate change-related factors adds an additional pressure on the necessity of encouraging water conservation behaviors. Recent studies generally report that the percentage of residential water-use for outdoor irrigation falls between 50% and 75% (Milesi et al., 2012). This finding becomes significant as more American homes install expansive turfgrass lawns, the largest irrigated crop sector in the U.S. by total area (Milesi et al., 2005). Increasing turfgrass area has been linked to increasing water usage (Devitt, Carstensen, & Morris, 2008) and according to Robbins and Birkenholtz (2003), is positively correlated with urbanization and suburban development. These trends demonstrate the importance of considering how water conservation practices may reduce water consumption for residential lawn irrigation.

In 2015, the state of California implemented pricing mechanisms that attempted to encourage water conservation, and prevent wasteful water-use due to severe drought conditions (California Environmental Protection Agency, 2016). Executive Order B-29-15 outlined California's policy for saving water, and increasing enforcements against water waste. Policies designed to save water stated that "the State Water Resources Control Board shall impose restrictions to achieve a statewide 25% reduction in potable urban water usage through February 28, 2016...and requires cities and towns to reduce usage as compared to amount used in 2013" (California Executive Department, 2016, p. 2). The Order also issued the Department of Water Resources (DWR), in collaboration with local agencies to "replace 50 million square feet of lawns and ornamental turf with drought tolerant landscapes" (California Executive Department, 2016, p. 2). Additionally,

the DWR was authorized funding for lawn replacement programs to help communities most in need. Furthermore, the DWR prohibited the use of potable water for outdoor irrigation, as well as irrigation for new homes not using a drip or microspray system. A rebate program led by the California Energy Commission was also underway which sought to offer monetary incentives to households to replace inefficient appliances. Policies designed to increase enforcement against water waste required urban suppliers to report water usage and conservation every month; increased efficient water systems (e.g. irrigation systems), and prohibited the amount of turfgrass lawns that could be used in the landscape.

In addition to conservation water pricing policies, the International Food Policy Research Institute (IFPRI) predicts future “conservation and technological improvements will lower per capita domestic water-use in developed countries with the highest per capita water consumption,” (Rosegrant, Cai, & Cline, 2002, p. 6) of which the U.S. qualifies. While there are numerous technological improvements to residential irrigation and best use practices, broad adoption of technologies like rain sensors and evapotranspiration controllers (Moore, 2012) is needed to aid in achieving IFPRI’s predicted trend by reducing the pressures of high national turfgrass coverage, and water-use associated with residential irrigation (Bremer, 2012; Devitt et al., 2008). Due to substantial variation around the country in information access, financial means, climate, and prevailing attitudes towards the environment, trained Extension professionals are uniquely positioned to facilitate broad adoption of these water-saving technologies and practices (Warner, Lamm, Rumble, Martin, & Cantrell, 2016; Welch & Braunworth, 2010).

Despite evidenced importance of water conservation, the general public’s lack of knowledge and demonstrated apathy towards water issues continues to hinder water conservation efforts (Devitt et al., 2008; Lamm, Lamm, & Carter, 2015). Many interventions targeting the general public promote widespread behavior change as a critical factor in achieving water conservation goals. However, the public remains less informed on water issues than leaders in the agriculture and natural resource fields (Lamm et al., 2015). On the other hand, adequate knowledge of an issue does not directly guarantee a change in behavior, even if the behavior’s benefits are well known.

There are several barriers that might inhibit the adoption of water conservation behaviors, including social norms: if the adoption of these behaviors contrasts with the behaviors accepted by the community, and personal norms: if adoption of these behaviors contradicts personal values (Doran & Larson, 2015). For example, studies comparing advanced irrigation systems to manual systems demonstrated a reduction in water consumption by an additional 20% over the control (Devitt et al., 2008). Yet standard irrigation controllers that require the user to enter the irrigation schedule were found to increase irrigation water volume in comparison to manual irrigation control (Loh & Cochlan, 2003; Syme, Shoa, Po, & Campbell, 2004). This trend is possibly the result of water users valuing time saved over water saved, and the perception that this technology is overly complex, due to the time it takes to manually set the schedule (Salvador, Bautista-Capetillo, & Playán, 2010). However, Syme et al. (2004) interpreted this trend to be a result of user error in setting the timer for extended irrigation periods or at high frequency. Because the impact of these barriers may be hard to distinguish, one might consider addressing both issues together. This can be done by extending education services on proper use of advanced irrigation systems while further investigating the impact of water conservation attitudes on the use of these technologies (Syme et al., 2004).



An additional barrier to the adoption of water conservation behaviors is the relatively low cost of water. A study conducted by Salvador et al. (2010) analyzing water-use behaviors of residents in Spain found that higher incomes and access to water at a lower cost were factors that contributed to the overirrigation of residential lawns. This suggests that users may value lawn aesthetic over water conservation, or associate low water cost with plentiful water. Because the low cost of water may hinder some water conservation efforts, Salvador et al. (2010) suggested that a “water pricing policy seems to be one of the most important tools for decreasing private landscape irrigation water use” (p. 303). These results demonstrate the necessity of informed public policy and user education to encourage water-conserving lawn irrigation practices.

As early as 1948, the U.S. government recognized the need to address water quality and quantity issues on a public policy level, passing the Water Pollution Control Act (WPC) as the first regulatory water control policy (Huang & Lamm, 2016). While several regulatory policies were passed after the WPC Act, public involvement has been lacking, possibly due to insufficient knowledge or lack of personal experience with water issues (Huang & Lamm, 2015). Several studies demonstrated the importance of civic engagement and public policy knowledge in the adoption of water conservation behaviors, and supported the expansion of Extension services to address this knowledge gap (Huang & Lamm, 2015). In addition to addressing knowledge gaps, extension programs have been proven to substantially improve the adoption of water conservation behaviors. For example, the 40 Gallon Water Challenge is an educational program adopted and implemented by the University of Georgia Center for Urban Agriculture to teach the general public about water conservation through voluntary behavior change pledges. As of December 2016, most participants (86%) were committed to their conservation pledges, totaling 1.8 million gallons of water saved per day. Notably, one of the most frequent pledges was reducing irrigation run times. The 40 Gallon Challenge is considered a “flexible, easy-to-use water conservation education tool” (Sheffield, Bauske, Pugliese, Kolich, & Boellstorff, 2016, p. 2) effective in encouraging “Extension audiences to adopt indoor and outdoor conservation practices” (p. 2).

Another study conducted in the Chinyanja Triangle of Southern Africa analyzed factors contributing to land, soil, and water conservation practices. The authors found that adopters of improved agricultural practices had a 10% advantage in accessing agricultural advice and Extension services than did non-adopters (Mango, Makate, Tamenes, Mponela, & Ndengu, 2017). The study concluded that “extension (agricultural advice) remains the main source of information on improved production methods and sustainable agricultural practices in smallholder agriculture” (Mango et al., 2017, p. 127). There is also significant evidence to suggest that extension programs are a worthwhile economic investment in a number of key focus areas. For example, a meta-analysis conducted by IFPRI analyzed all evidence of return in agricultural research and development published since 1953. Findings suggested that the rate of return in economic investment for Extension services was 62.9%, just above the accepted normal range of 40%-60% return on agricultural research (Alston, Chang-Kang, Marra, Pardy, & Wyatt, 2000). Collectively, Extension services have demonstrated substantial potential to improve public awareness and behavior change, and in several cases, provide the opportunity for positive economic return. With these considerations in mind, broadening extension programs that address residential irrigation may prove beneficial to reducing national domestic water consumption.

Across the U.S., the intersectional issues of population growth, urbanization, and climate change have begun to experience greater public awareness. As water users begin to experience the effects of these factors on a personal level, further research may be appropriate to investigate the correlation between public awareness or personal experience with these issues, and adoption of water conservation behaviors. Measuring factors such as attitudes, norms, perceived behavioral control, and perceived cost of water may help Extension professionals further refine and strengthen behavior change in water conservation programs.

### **Purpose and Objectives**

The research described in this paper was guided by the Theory of Planned Behavior (TPB), and sought to determine factors affecting urban residents' intent to engage in water conservation in the United States. The specific objectives were to:

- Evaluate the influence of TPB factors on intention to engage in water conservation
- Evaluate the influence of perceived cost, and personal norms on intention to engage in water conservation

### **Theoretical Framework**

The TPB expands the Theory of Reasoned Action (TRA), which accounts for cognitive processes of a persons' control over performing a behavior (Ajzen, 2012). The TPB comprises three main variables: *attitudes*, *social norms*, and *perceived behavioral control (PBC)* that affect intention to engage in some behavior. Behavioral beliefs are a person's attitude towards the behavior; that is whether performance of the behavior is positively or negatively valued by the individual. Normative beliefs, or social norms, are the social pressures to engage or not engage in the behavior. This is, what do others expect of me? Control beliefs comprise an individual's perception of their ability to perform the behavior, that is, their perceived behavioral control. PBC is a proxy for actual behavioral control which is the degree of resources and skills a person requires to perform the behavior (Ajzen, 2012). PBC can directly impact behavior if all prerequisites needed to perform the behavior are present. In summary, the theory states that "the more favorable a person's attitude and social norms, and the more they believe they are capable of performing the behavior, the stronger should be their behavioral intentions (Ajzen, 2012, p. 447).

Previously, the TPB has been applied in behavior change and adoption of water conservation practices. However, it does not include potential factors influencing water conservation practices such as personal norms or perceived cost of water. In some studies, these factors were found to be important considerations impacting water conservation practices. Attari (2014) investigated perceptions of water-use and found improving the public's understanding of their personal water-use can impact strategies geared towards the adoption of water-saving practices. Fan, Wang, Liu, Yang, & Qin (2014) found significant associations between resident perception of personal water-use and actual water-use. Particularly, residents underestimated their outdoor water-use and overestimated the amount of water consumed indoors. Ultimately, those who accurately

estimated their water-use had better awareness of water conservation practices compared to those who did not. As such, Extension initiatives that target awareness of water-use (through norms) could support the acceptance and implementation of water conservation practices.

The perceived cost of water has been explored from various perspectives with mixed results on conservation behaviors, partly because of the complexity of this approach (Saurí, 2013). Block rates and levies on consumer water-use were two of several strategies used in Singapore to reduce water-use (World Bank, 2006), although this strategy may be ineffective among higher-income consumers (Corral-Verdugo, Frías-Armenta, Tapia-Fonllem, & Frijo-Sing, 2012). However, there is promise in exploring the perceived cost of water as part of a behavior change strategy because “the efficacy of pricing for water conservation appears to be higher for outdoor uses than for indoor uses” (Saurí, 2013, p. 233). Jordan (2011) highlighted that pricing information necessary for decision-making was not provided on water bills as compared to other goods. Additionally, information given on the bill did not clearly articulate to the consumer how much water was actually being used. In a survey conducted with 400 people from Georgia, about 62% were aware of their water bill while 26% were unaware as this cost was included in their rent. Since the cost of water could be made more clear to consumers and can play a role in motivating outdoor water conservation, the perceived cost of water is an important factor when considering changing water consumption behaviors.

Ultimately, norms are powerful tools Extension professionals can use to stimulate changes in behavior (Kumar Chaudhary, Warner, Lamm, Rumble, & Cantrell, 2015). Particularly, personal norms or “self-expectations for behavior backed by the anticipation of self-enhancement or depreciation” (Schwartz & Fleishman, 1978, p. 307) shape an individual’s decision to act. Such obligations to oneself to perform an act are useful when considering behavior change strategies. In the study by Kumar Chaudhary et al. (2015), over 80% of participants agreed they had a personal responsibility to conserve water in the landscape. In other recent studies, social and personal norms have shown promising signs of encouraging pro-environmental behavior change (de Groot, Abrahamse, & Jones, 2013).

## **Methods and Procedures**

The theoretical target audience for this study were urban residents in the United States who engaged in landscaping and irrigation practices. It should be noted that this audience is different from the general population and is an important target audience having the most potential to conserve water in the landscape (Warner, Lamm, Rumble, Martin, & Cantrell, 2016). A sampling frame was developed using an online survey company employing a purposive sampling technique. Therefore, results of this study should not be generalized. Screening questions were used to confirm that those in the sampling frame had a lawn /landscape, had an irrigation system, and had control of their home irrigation system. Thus, the final sample size (*N*) obtained was 1,809. A researcher-developed questionnaire was administered via an online survey. Overall, most respondents (70.0%) were female, and on average 41 years of age where 34.3% had a 4-year college degree, and 21.9% earned between \$50,000 to \$74,000 per year.

To ensure validity, the questionnaire was reviewed by an expert panel qualified in urban water resources engineering, extension education, and water conservation. To test for reliability, a pilot study was conducted to ensure no significant issues concerning question construction and ordering were found. Construct variables used in this study were, attitudes, social norms, PBC, personal norms, perceived cost of water, and intent to engage in water conservation. The reliabilities for all variables were between 0.69 to 0.89 indicating acceptable internal consistency (Field, 2006). See Table 1.

## Constructs

Each index was developed by averaging all items under each construct shown in Table 1. Five statements comprised the attitudes construct that used the question stem, *please indicate your attitude toward the phrase, "Implementing good irrigation practices is..."*. Responses were measured on a 5-point scale where a higher score (toward 5) indicated a positive attitude toward good irrigation practices. The social norms construct included four statements and used a 5-point Likert scale from *strongly disagree* to *strongly agree*. The question stem used for this question was, *please indicate your level of agreement or disagreement with the following statements*. A higher score (toward five) suggested a higher level of agreement. PBC was measured on a 5-point scale and consisted of five statements using the question stem, *please indicate how you feel about the phrase "Implementing good irrigation practices is..."*. A higher PBC score (toward five) indicated greater ability or control to engage in good irrigation practices. The perceived cost of water construct included three statements ranging from *strongly disagree* to *strongly agree* on a 5-point Likert scale. The question stem used was, *for this question, please think about the cost of water*. A higher score (toward five) for perceived cost of water indicated a higher level of agreement. Four statements comprised the personal norms construct which ranged on a 5-point scale from *strongly disagree* to *strongly agree*. The question stem for this question was, *please indicate your level of agreement or disagreement with the following statements*". A higher score (toward five) for this construct meant a higher level of agreement. Twelve statements were included for the intent to engage in water conservation construct which used the question stem, *please indicate how unlikely or likely you are to engage in the following water conservation behaviors in the future*. Responses were measured on a 5-point Likert scale from *very unlikely* to *very likely* where a higher score (tending toward five) indicated greater intent to engage in water saving activities.

Table 1  
*Reliabilities for all variables*

Indexes and individual items	Cronbach's alpha ( $\alpha$ )
Attitudes	0.85
Good: Bad*	
Important: Unimportant*	
Foolish: Wise	
Beneficial: Harmful*	
Positive: Negative*	
Unnecessary: Necessary	
Social norms	0.81

The people who are important to me expect that I will manage my landscaping using the smallest amount of water possible	
The people who are important to me expect me to avoid watering the landscape when it is raining	
The people who are important to me would approve if I conserve water in my home landscape	
The people who are important to me would expect that I use good landscape watering practices	
Perceived Behavioral Control	0.86
Possible for me: Not possible for me*	
Easy for me: Not easy for me*	
In my control: Not in my control*	
Up to me: Not up to me*	
Practical for me: Not practical for me*	
Perceived cost of water	0.69
If my water bill was more expensive, I would use less water on my lawn /landscape	
The cost of my water bill affects how much I water my lawn /landscape	
If my water bill was less expensive, I would use more water on my lawn /landscape	
Personal norms	0.82
It is important to manage my landscape using the smallest amount of water possible	
I feel a personal obligation to water my landscape using only what is needed	
It is important to encourage my friends and family to manage their landscape using the smallest amount of water possible	
I feel a personal obligation to explore ways to reduce my landscape's impact on water quantity	
Intent	0.89
Eliminate irrigated areas in my landscape	
Turn off zone(s) or cap irrigation heads for established woody plants	
Convert turf-grass areas to landscaped beds	
Replace high water plants with drought tolerant plants	
Replace high volume irrigated areas with low volume irrigation	
Install smart irrigation controls (such as soil moisture sensors (SMS) or an evapotranspiration device (ET)) so irrigation will not turn on when it is not needed	
Calibrate my sprinklers	
Use a rain gauge to monitor rainfall for reducing/skipping irrigation	
Use a rain barrel or cistern	
Use different irrigation zones/zone run times based on plants' irrigation needs	
Seasonally adjust irrigation times	
Follow watering restrictions	

\*Items reversed in survey to reduce response-set bias.

## Interpretation of constructs

For the dependent variable intent, a higher score indicated a greater likelihood to engage in irrigation best practices. For the independent variable attitude, a higher score indicated more positive attitudes toward good irrigation practices. Higher social norms scores indicated a greater level of agreement concerning the expectations others had of an individual to conserve water in their landscape. Higher perceived behavioral control scores indicated greater perceived ability to engage in good irrigation practices. A higher perceived cost of water score indicated a greater perception that the cost of water influenced personal water-use. Higher personal norms scores indicated greater personal obligation to conserve water in the landscape.

## Analysis

Two models were tested using multiple regression analysis. For Model 1, independent variables (predictors of intention) were aligned with the TPB variables - attitudes toward implementing good irrigation practices, perceived social norms about water conservation, and perceived control over implementing good irrigation practices. The dependent variable was intent to engage in water conservation. Model 1, was, therefore,

$$I = f(A, SN, PBC)$$

Where  $I$  = intent to engage in water conservation;  $A$  = attitudes toward implementing good irrigation practices;  $SN$  = perceived social norms; and  $PBC$  = perceived control over engaging in good irrigation practices.

In model 2, two additional independent variables - perceived cost of water and personal norms regarding water quantity (using good irrigation practices to conserve water) were added to the TPB variables in model 1. These variables were included in a new model; Model 2:

$$I = f(A, SN, PBC, PC, PN)$$

Where  $PC$  = perceived cost of water;  $PN$  = personal norms concerning using good irrigation practices.

## Results

### Evaluate the influence of TPB factors on intention to engage in water conservation

Table 2 presents the results for the TPB variables (Model 1). Overall, the model was statistically significant ( $F = 125.88$ ;  $p < 0.001$ ), and independent variables explained 17.3% of the variance in intent to engage in water conservation. Both social norms and PBC were statistically significant variables in the model. There was a statistically significant and positive association between social norms and intent to engage in water conservation ( $t = 14.94$ ,  $p < 0.001$ ). A one standard deviation unit (SD-unit) increase in perceived social norms was associated with a 0.341 SD-unit predicted increase in intent to engage in water conservation. That is, an increase in social norms (the expectations others had of an individual to conserve water) was positively correlated with an increase in intent to engage in water conservation.

There was also a statistically significant and positive association between PBC and intent to engage in water conservation ( $t = 6.35$ ,  $p < 0.001$ ). A one SD-unit increase in PBC to implement good irrigation practices was associated with a 0.166 SD-unit predicted increase in intent to

engage in water conservation. Therefore, an increase in a person’s perceived ability to engage in good irrigation practices was positively correlated with intent to engage in water conservation. Overall, social norms had a stronger effect (0.341) on intent to engage in water conservation than PBC (0.167).

Table 2  
*OLS results for Model 1 – TPB variables*

Variable	$\beta$	Std. Error	<i>t</i>	Std. $\beta$	<i>p</i>
Constant	1.556	0.168	9.247	-	0.000
Attitudes	-0.038	0.039	-0.975	-0.025	0.329
Social norms	0.390	0.026	14.939	0.341	0.000***
PBC	0.195	0.031	6.350	0.166	0.000***

Note. \* $p < 0.05$ , \*\* $p < 0.01$ , \*\*\* $p < 0.001$ .  $R^2 = 0.173$  ( $F = 125.88$ ,  $p < 0.001$ )

### Evaluate the influence of perceived cost and personal norms on intention to engage in water conservation

Table 3 presents results for the inclusion of two additional independent variables; perceived cost of water and personal norms (Model 2). The omnibus *F* test indicated that the model was statistically significant ( $F = 131.21$ ;  $p < 0.001$ ), and independent variables explained 26.7% of the variation in intent to engage in water conservation. All variables in the model had statistically significant correlations with intent to engage in water conservation. Notably, there was a statistically significant and negative association between attitudes and intent to engage in water conservation ( $t = -2.11$ ,  $p < 0.05$ ). A one SD-unit increase in attitudes (toward positive) was associated with a 0.051 SD-unit predicted decrease in intent to engage in water conservation. That is, an increase in positive attitudes was negatively correlated with intent to engage in water conservation.

There was also a statistically significant and positive relationship between social norms and intent to engage in water conservation ( $t = 6.48$ ,  $p < 0.001$ ). A one SD-unit increase in perceived social norms was correlated with a 0.161 SD-unit predicted increase in intent to engage in water conservation. That is, an increase in social norms (the expectations others had of an individual to conserve water) was positively correlated with an increase in intent to engage in water conservation. There was a statistically significant and positive association between PBC and intent to engage in water conservation ( $t = 4.67$ ,  $p < 0.001$ ). A one SD-unit increase in PBC was associated with a 0.116 SD-unit predicted increase in intent to engage in water conservation. Therefore, an increase in a person’s perceived ability to engage in good irrigation practices was positively correlated with intent to engage in water conservation. Additionally, both personal cost (PC) and personal norms (PN) had statistically significant associations with intent to engage in water conservation. There was a statistically significant and positive association between PC and intent to engage in water conservation ( $t = 5.89$ ,  $p < 0.001$ ). A one SD-unit increase in perceived cost of water was positively associated with a 0.121 SD-unit predicted increase in intent to engage in water conservation. That is, an increase in the perceived cost of water was positively correlated with intent to engage in water conservation. There was also a statistically significant and positive relationship between PN and intent to engage in water conservation ( $t = 13.25$ ,  $p < 0.001$ ). A one SD-unit increase in personal norms concerning using good irrigation

practices was positively associated with a 0.338 SD-unit predicted increase intent to engage in water conservation. An increase in personal obligations to conserve water in the landscape increased was positively correlated with intent to engage in water conservation. Overall, personal norms had the strongest effect (0.338) on intent to engage in water conservation.

Table 3

*OLS results for Model 2 – Inclusion of cost and personal norms variables*

<b>Variable</b>	<b><math>\beta</math></b>	<b>Std. Error</b>	<b><i>t</i></b>	<b>Std. <math>\beta</math></b>	<b><i>p</i></b>
Constant	0.847	0.169	4.999	-	0.000
Attitudes	-0.078	0.037	-2.111	-0.051	0.035*
Social norms	0.184	0.028	6.477	0.161	0.000***
PBC	0.136	0.029	4.669	0.116	0.000***
PC	0.097	0.017	5.892	0.121	0.000***
PN	0.404	0.030	13.245	0.338	0.000***

Note. \* $p < 0.05$ , \*\* $p < 0.01$ , \*\*\* $p < 0.001$ .  $R^2 = 0.267$  ( $F = 131.21$ ,  $p < 0.001$ )

### **Conclusions and Recommendations**

This study utilized the Theory of Planned Behavior (TPB) to determine significant factors affecting urban residents' intent to engage in water conservation. When considering only those variables in the TPB, social norms and perceived behavioral control (PBC) are statistically significant predictors of intent to conserve water. Additionally, social norms have a stronger impact on intent to engage in water conservation than PBC. This result is similar to the results reported by de Groot et al. (2013), highlighting the significance of social norms to encourage pro-environmental behaviors. As such, social norms are essential tools for activating decision-making processes to act.

With the inclusion of two additional independent variables, personal cost (PC), and personal norms (PN), all variables are statistically significant predictors of intent to conserve water. That is, attitudes, social norms, PBC, PC, and PN are all influential on intent to conserve water. Notably, attitudes are not statistically significant in the first model but are in the second model, negatively correlating with intent to engage in water conservation. While it is not fully clear why, this finding might suggest that attitudes alone do not translate to behavior change (in accordance with the TPB). The inverse relationship might also be explained by a disconnect between having positive attitudes and action. That is, people may feel positively about water conservation, but do not intend to conserve water perhaps because it is not an immediate priority. Another explanation could be that water issues have become so common and perceived as necessary, residents may intend to conserve even if they view doing so negatively. The inverse relationship between attitudes and intent should be further explored.

Other factors, particularly motivation to act, should also be an important consideration as it can be influenced by norms (Schultz, 1999). Social norms and PBC are statistically significant predictors of intent to conserve (model 1), again consistent with previous studies. When all variables are considered (model 2), personal norms have the strongest effect on intent to engage in water conservation. This finding also highlights the importance of personal norms on intentions to act which is again similar to findings by de Groot et al. (2013) and Schwartz and Fleishman (1978). Perceived cost of water is also a statistically significant predictor of intent to



engage in water conservation, suggesting the importance of residents' perceptions of water-use (Attari, 2014), and awareness of how much their water costs.

Both social and personal norms have the greatest effect on intent to engage in water conservation. This finding highlights the significance of norms as factors of intent, and eventual behavior adoption, consistent with literature by Schultz (1999). As a result, the researchers recommend making known (and implementing together) social and personal norms in extension water conservation programs. The use of norms in water conservation programs can increase resident awareness of water-use, and ultimately inspire engagement in water saving practices. Extension professionals should work among their clientele to develop social communities that collectively identify irrigation water conservation as a core value, and encourage individuals to see this value as part of their identity.

Similar to the study by Schultz (1999), feedback interventions could be implemented to communicate a person's task performance (what is) and some abstract standard (what should be). These abstract standards in the intervention are personal and social norms, and once made apparent (activated), could influence action. As such, Extension professionals can use messages reinforcing personal and social norms to encourage water conservation. For example, they might provide information on resident's personal water-use along with feedback on their community/neighbors' water-use while conveying irrigation water conservation as a shared value. Message design and testing should be conducted to determine how best to build these personal and social norms among residents.

Future studies can explore a person's awareness of their water bill and the perceived amount allocated to outdoor irrigation. An experimental design can be used to determine if knowledge of water cost would influence changes in the amount of water used for outdoor irrigation. Based on the literature by Jordan (2011) and Saurí (2013), the difference between awareness of water consumption, and consuming less water based on income and cost is one possible area that can be studied. Because people don't have a clear understanding of the actual cost of water used for the lawn and landscape, it is unknown whether clarifying the actual cost could play a role in eliciting water conservation behaviors or if existing price structures would need to be modified. There are likely instances where one possible strategy would be more effective than the other, and residents' personal characteristics may influence the approach taken. Additionally, since personal norms have the greatest effect on intent, a field experiment could be used to test this result in the context of extension programming. Furthermore, the disconnect between positive attitudes and action is an area that can be investigated to explain this finding. Comparing the results of future research to this study will help determine the accuracy of these recommendations.

## References

- Ajzen, I. (2012). The theory of planned behavior. In P. A. M. Lange, A. W. Kruglanski & E. T. Higgins (Eds.), *Handbook of Theories of Social Psychology* (pp. 439–459). London, UK: Sage.
- Alston, J. M., Chan-Kang, C., Marra, M. C., Pardey, P. G., & Wyatt, T. (2000) *A meta-analysis of rates of return to agricultural R&D* (Research Report 113). Washington D.C.: International Food Policy Research Institute. Retrieved from <http://ebrary.ifpri.org/utils/getfile/collection/p15738coll2/id/125334/filename/125335.pdf>
- Attari, S. Z. (2014). Perceptions of water use. *Proceedings of the National Academy of Sciences, USA*, 111(14), 5129–5134. Retrieved from <http://www.pnas.org/content/suppl/2014/02/26/1316402111.DCSupplemental>
- Bremer, D. J., Keeley, S. J., Jager, A., Fry, J. D., & Lavis, C. (2012). In-ground irrigation systems affect lawn-watering behaviors of residential homeowners. *HortTechnology*, 22(5), 651–658. Retrieved from <http://horttech.ashspublications.org/content/22/5/651.full.pdf+html>
- California Executive Department. (2016). *Executive order B-29-15*. Retrieved from [https://www.gov.ca.gov/docs/4.1.15\\_Executive\\_Order.pdf](https://www.gov.ca.gov/docs/4.1.15_Executive_Order.pdf)
- California Environmental Protection Agency. (2016). *Conservation water pricing*. Retrieved from [https://www.waterboards.ca.gov/waterrights/water\\_issues/programs/drought/pricing/](https://www.waterboards.ca.gov/waterrights/water_issues/programs/drought/pricing/)
- Colby, S. L., & Ortman, J. M. (2015). *Projections of the size and composition of the U.S. population: 2014 to 2060* (Current Population Reports, P 25-1143). Washington, DC: U.S. Census Bureau, Retrieved from <https://www.census.gov/content/dam/Census/library/publications/2015/demo/p25-1143.pdf>
- Corral-Verdugo, V., Frías-Armenta, M., Tapia-Fonllem, C. O., & Frijó-Sing, B. S. (2012). Protecting natural resources: Psychological and contextual determinants of freshwater conservation. In S. Clayton (Ed.), *The Oxford Handbook Of Environmental And Conservation Psychology* (pp. 581-597). New York, NY: Oxford University Press.
- de Groot, J. I. M., Abrahamse, W., & Jones, K. (2013). Persuasive normative messages: The influence of injunctive and personal norms in using free plastic bags. *Sustainability*, 5, 1829–1844. doi:10.3390/su5051829
- Devitt, D. A., Carstensen, K., & Morris, R. L. (2008). Residential water savings associated with satellite-based ET irrigation controllers. *Journal of Irrigation and Drainage Engineering*, 34(1), 74–82. doi:10.1061/ ASCE 0733-9437
- Doran, R., & Larson, S. (2015). The relative importance of social and personal norms in explaining intentions to choose eco-friendly travel options. *International Journal of Tourism Research*, 18, 159–166. doi:10.1002/jtr.2042
- Fan, L., Wang, F., Liu, G., Yang X., & Qin, W. (2014). Public perception of water consumption and its effects on water conservation behavior. *Water*, 6, 1771–1784. doi:10.3390/w6061771
- Field, A. (2006). *Reliability analysis*. Retrieved from <http://www.discoveringstatistics.com/docs/reliability.pdf>
- Huang, P., & Lamm, A. J. (2016). Impact of experience and participation in extension programming on perceptions of water quality issues. *Journal of International Agricultural and Extension Education*, 22(3). doi:10.5191/jiaee.2015.22303.

- Huang, P., & Lamm, A. J. (2015). Understanding public engagement in water conservation behaviors and knowledge of water policy: Promising hints for extension. *Journal of Extension*, 53(6). Retrieved from [https://www.joe.org/joe/2015december/pdf/JOE\\_v53\\_6rb1.pdf](https://www.joe.org/joe/2015december/pdf/JOE_v53_6rb1.pdf)
- Jordan, J. L. (2011). *Pricing to encourage conservation: Which price? Which rate structure?* Retrieved from <http://opensiuc.lib.siu.edu/cgi/viewcontent.cgi?article=1221&context=jcwre>
- Kumar Chaudhary, A., Warner, L. A., Lamm, A., Rumble, J. N., & Cantrell, R. (2015). Encouraging landscape water conservation behaviors series overview #7: Personal and social norms of Florida residents who use irrigation in the home landscape. *Electronic Data Information Source (EDIS)*, AEC543. Retrieved from <http://edis.ifas.ufl.edu/wc205>
- Lamm, K., Lamm, A., & Carter, H. (2015). Bridging water issue knowledge gaps between the general public and opinion leaders. *Journal of Agricultural Education*, 56(3), 146–161. doi:10.5032/jae.2015.03146
- Loh, M. T., & Cochlan, P. (2003). *Domestic Water Use Study in Perth, Western Australia. 1998–2001*. Australia, Perth: Water Corporation of Western Australia. Retrieved from [https://www.water.wa.gov.au/\\_\\_data/assets/pdf\\_file/0016/5029/42338.pdf](https://www.water.wa.gov.au/__data/assets/pdf_file/0016/5029/42338.pdf)
- Mango, N., Makate, C., Tameness, L., Mponela, P., & Ndengu, G. (2017). Awareness and adoption of land, soil and water conservation practices in the Chinyanja Triangle, Southern Africa. *International Soil and Water Conservation Research*, 5(2), 122–129. <https://doi.org/10.1016/j.iswcr.2017.04.003>
- Maupin, M. A., Kenny, J. F., Hutson, S. S., Lovelace, J. K., Barber, N. L., & Linsey, K. S. (2010). *Estimated Use of Water in the United States in 2010* (U.S. Geological Survey Circular 1405, Rep.). Reston, Virginia: U.S. Geological Survey. Retrieved from <https://pubs.usgs.gov/circ/1405/pdf/circ1405.pdf>
- Mayer, P. W., DeOreo, W. B., Opitz, E. M., Kiefer, J. C., Davis, W. Y., Dziegielewski, B., & Nelson, J. O. (1999). *Residential End Uses of Water*. Denver, Colorado: AWWA Research Foundation and American Water Works Association. Retrieved from [http://www.waterrf.org/PublicReportLibrary/RFR90781\\_1999\\_241A.pdf](http://www.waterrf.org/PublicReportLibrary/RFR90781_1999_241A.pdf)
- Milesi, C., Running, S. W., Elvdige, C. D., Dietz, J. B., Tuttle, B. T., & Nemani, R. R. (2005). Mapping and modeling the biogeochemical cycling of turf grasses in the United States. *Environmental Management*, 36(3), 426–438. doi:10.1007/s00267-004-0316-2
- Milesi, C., Elvdige, C. D., Dietz, J. B., Tuttle, B. T., Nemani, R. R., & Running, R. W. (2012). *A Strategy for Mapping and Modeling the Ecological Effects of US Lawns*. Moffett Field, California: NASA Ames Research Center. Retrieved from [https://www.researchgate.net/publication/228337532\\_A\\_strategy\\_for\\_Mapping\\_and\\_Modeling\\_the\\_Ecological\\_Effects\\_of\\_US\\_Lawns](https://www.researchgate.net/publication/228337532_A_strategy_for_Mapping_and_Modeling_the_Ecological_Effects_of_US_Lawns)
- Miller, K., & Yates, D. (2006). *Climate change and water resources: A primer for municipal water providers*. Retrieved from <http://waterinstitute.ufl.edu/WorkingGroups/downloads/WRF%20Climate%20Change%20DocumentsSHARE/Project%202973%20-%20Climate%20Change%20and%20Water%20Resources.pdf>
- Moore, K. (2012). Urban irrigation challenges and conservation. In *Irrigation Systems and Practices in Challenging Environments*. (pp. 343–360). Rijeka, Croatia: InTech. doi:10.5772/29023

- Parry, M. L., Canziani, O. F., Palutikof, J. P., Van der Linden, P. J., & Hanson, C. E. (2007). *Contribution of Working Group II to the Fourth Assessment Report of the Intergovernmental Panel on Climate Change, 2007*. United Kingdom, Cambridge: Intergovernmental Panel on Climate Change. Retrieved from [https://www.ipcc.ch/publications\\_and\\_data/ar4/wg2/en/ch3s3-5-1.html](https://www.ipcc.ch/publications_and_data/ar4/wg2/en/ch3s3-5-1.html)
- Robbins, P., & Birkenholtz, T. (2003). Turfgrass revolution: Measuring the expansion of the American lawn. *Land Use Policy*, 20, 181–194. doi:10.1016/S0264-8377(03)00006-1
- Rosegrant, M. W., Cai, X., & Cline, S. A. (2002). *Global Water Outlook to 2025 Averting an Impending Crisis*. D.C., Washington: International Food Policy Research Institute. Retrieved from <http://ebrary.ifpri.org/utils/getfile/collection/p15738coll2/id/59063/filename/59064.pdf>
- Salvador, R., Bautista-Capetillo, C., & Playán, C. (2010). Irrigation performance in private urban landscapes: A study case in Zaragoza (Spain). *Landscape and Urban Planning*, 100, 302–311. doi:10.1016/j.landurbplan.2010.12.018
- Saurí, D. (2013). Water conservation: Theory and evidence in urban areas of the developed world. *Annual Review of Environmental Resources*, 38, 227–248. doi:10.1146/annurev-environ-013113-142651
- Schwartz, S. H., & Fleishman, J. A. (1978). Personal norms and the mediation of legitimacy effects on helping. *Social Psychology*, 41(4), 306–315. doi:10.2307/3033583
- Sheffield, M. C., Bauske, E., Pugliese, P., Kolich, H. & Boellstorff, D. (2016). Implementing the 40-gallon challenge to increase water conservation. *Journal of Extension*, 54(6). Retrieved from [https://joe.org/joe/2016december/pdf/JOE\\_v54\\_6tt1.pdf](https://joe.org/joe/2016december/pdf/JOE_v54_6tt1.pdf)
- Syme, G. J., Shao, Q., Po, M., & Campbell, E., (2004). Predicting and understanding home garden water use. *Landscape and Urban Planning*, 68(1), 121–128. doi:10.1016/j.landurbplan.2003.08.002.
- United Nations, Department of Economic and Social Affairs, Population Division. (2016). *The world's cities in 2016 - Data booklet*. Retrieved from [http://www.un.org/en/development/desa/population/publications/pdf/urbanization/the\\_worlds\\_cities\\_in\\_2016\\_data\\_booklet.pdf](http://www.un.org/en/development/desa/population/publications/pdf/urbanization/the_worlds_cities_in_2016_data_booklet.pdf)
- United Nations, Department of Economic and Social Affairs, Population Division. (2009). *World population prospects: The 2008 revision, highlights* (Working Paper No. ESA/P/WP.210). Retrieved from [http://www.un.org/esa/population/publications/wpp2008/wpp2008\\_highlights.pdf](http://www.un.org/esa/population/publications/wpp2008/wpp2008_highlights.pdf)
- United States Census Bureau. (2017). *U.S. and world population clock*. Retrieved from <https://www.census.gov/popclock/>
- Warner, L. A., Lamm, A. J., Rumble, J. N., Martin, E., & Cantrell, R. (2016). Classifying residents who use landscape irrigation: Implications for encouraging water conservation behavior. *Environmental Management*, 58(2), 238–253. doi:10.1007/s00267-016-0706-2.
- Welch, T., Braunworth, W. S. (2010). Education in the face of controversy: When water and politics mix. *Journal of Extension*, 48(3). Retrieved from [https://www.joe.org/joe/2010june/pdf/JOE\\_v48\\_3a1.pdf](https://www.joe.org/joe/2010june/pdf/JOE_v48_3a1.pdf)
- World Bank. (2006). Dealing with water scarcity in Singapore: Institutions, strategies, and enforcement. *World Bank Analytical and Advisory Assistance (AAA) Program China: Addressing Water Scarcity, Background Paper No. 4*. Retrieved from [http://siteresources.worldbank.org/INTEAPREGTOPENVIRONMENT/Resources/WRM\\_Singapore\\_experience\\_EN.pdf](http://siteresources.worldbank.org/INTEAPREGTOPENVIRONMENT/Resources/WRM_Singapore_experience_EN.pdf)

## **Saving Water in the City: Behavioral Research to Inform Urban Landscape Water Conservation Extension Programs**

Laura A. Warner, University of Florida  
John M. Diaz, University of Florida  
Anil Kumar Chaudhary, Pennsylvania State University

### **Abstract**

Water availability is an important issue addressed by Cooperative Extension programs nationwide. Rapid population growth and urbanization present unique challenges and opportunities for Extension programming. In this study, we explored whether urban Extension audiences in Florida had unique characteristics that could be used to design tailored programs. We used electronic surveys to collect water conservation and landscape management behaviors along with demographic information. Applying audience segmentation concepts, we divided respondents into subgroups by rural-urban continuum codes. We then described the resulting subgroups and made comparisons to identify differences that could inform Extension programming. The most urban residents had lived in Florida the longest, were least engaged in water conservation practices, most likely to use a professional landscape company for landscape maintenance activities, and most likely to reside in a homeowners' association. The findings revealed somewhat of a disconnect between urban residents and water resources. Understanding these differences among urban audiences can be useful insights to guide impactful Extension programs. Urban landscape water conservation programming should be designed to build a connection between residents and their local water bodies and should engage the many partners present in urban systems. More research is needed to examine the relationship between residing in more urban areas and engaging less in landscape water conservation practices.

### **Introduction**

There is growing evidence that human activities are placing unsustainable demands on fresh water resources with groundwater supplies being over extracted and many major river systems experiencing inadequate water flows (Fielding, Russel, Spinks, & Mankad, 2012; NRDC, 2010). With projected population growth and increased economic development, water resources will continue to be placed under pressure and that will likely be further exacerbated by climate change (Fielding et al., 2012; IPCC 2008; NRDC, 2010). A study conducted by the National Resources Defense Council (2010) found that more than 1,100 counties will face higher risks of water shortages with the Midwest and South, particularly Florida, projected to be confronted with extremely high risk of water shortages. Water security poses a serious challenge for policy makers and other key stakeholders who need to promote strategies that meet the increasing human demand for water while not compromising fragile ecosystems (Fielding et al., 2012; NRDC, 2010).

The country's population has shifted dramatically and more than 80% of America's population is considered urban (U.S. Census Bureau, 2010). As the population continues to change, it is important to identify strategies "that will allow Extension to maximize and demonstrate its potential impact in all locations for all people" (Harder & Wells, 2017, p. 55). Urban populations

comprise an important and under reached audience that will need to be served for Extension to continue its success as a change agency and commitment to the land-grant mission (National Urban Extension Leaders, 2015; Ruemenapp, 2017; Warner, Vavrina, Campbell, Elliott, Northrop, & Place, 2017). Trends toward more urban populations have opened up “vast possibilities” (Tiffany, 2017, p. 38) for Extension professionals serving communities nationwide. While urban Extension should not be seen as a separate entity, it may be accompanied by unique challenges and approaches. Partnerships, diversity, overlapping governmental jurisdiction, the existence of other service providers, recruitment of community members, access to technology, and specialized training needs are some distinguishing characteristics of urban Extension (Harder & Wells, 2017; National Urban Extension Leaders, 2015; Ruemenapp, 2017; Tiffany, 2017; Warner et al., 2017).

As a policy tool, education plays an important role in raising environmental awareness and promoting conservation behaviors to ensure future water security. Since the majority of household water use is applied to landscape irrigation, organizations such as Extension are focusing on influencing residential landscape practices through education to promote water conservation (St. Hilaire et al., 2008; Warner, Lamm, Rumble, Martin, & Cantrell, 2015; Warner & Lamm, 2017). In Florida, Extension promotes residential landscape water conservation through practices such as low-volume irrigation and precise irrigation scheduling techniques (University of Florida / Institute of Food and Agricultural Sciences Extension, 2013).

Studies have shown there are key determinants of household conservation including demographic, psychosocial, behavioral, and infrastructure variables that influence water use (Fielding et al., 2012; Warner & Lamm, 2017). Complex issues such as water scarcity are likely to affect clientele regardless of where they live (National Urban Extension Leaders, 2015). However, it is important to consider rural and urban audiences may exert different influences on participation in environmentally supportive behavior that may be important and need to be incorporated in Extension programs promoting water conservation (Huddart-Kennedy, Beckley, McFarlane & Nadeau, 2009). It is critical for Extension to deliver innovative programs that meet the needs of urban audiences (Harder, Lamm, & Strong, 2010).

A lack of understanding of how rural and urban audiences potentially differ may pose a significant obstacle for educators working with urban audiences who reside in areas that are at the highest risk of water shortages. For Extension to have a fundamental urban impact, it will be vital for local Extension faculty and staff, state systems, and the national system to understand how to position water conservation programs in large metropolitan regions (Ruemenapp, 2017). Behavioral market research can be used for such a purpose to understand and predict habits, responses and decisions people make regarding their residential water use (DeVault, 2016; McKenzie-Mohr, 2000). The process of integrating market research with Extension practice is essential for developing educational programs that promote sustainable behavior (McKenzie-Mohr, 2000). As Extension strives to remain relevant to all clientele, understanding these differences will strengthen educational interventions based on the needs of each specific audience and contribute to the advancement of urban Extension.

## Conceptual Framework

Extension has recently embraced *social marketing*, or the application of commercial marketing principles to encourage behavior change that benefits the target audience and society as a whole (McKenzie-Mohr, Lee, Schultz, & Kotler, 2012; Rogers, 2003). *Audience segmentation* is one social marketing principle which “breaks down a heterophilous audience into a series of relatively more homophilous subaudiences” (Rogers, 2003, p. 292). Educational programs that ignore the inherent variability among a potential audience and use one approach are likely to be ineffective (Andreasen, 2006). When employing concepts of audience segmentation Extension should design different strategies for different subgroups (Lee & Kotler, 2011).

There are an unlimited number of audience segmentation strategies, ranging from subdividing a potential audience by demographic characteristics to grouping them by behavioral or psychological profiles (Andreasen, 2006). Possible audience segments can be evaluated and prioritized by those who are easiest to reach, most likely to take action, or most in need of making a change, among others (Lee & Kotler, 2011). As adult educators, Extension professionals need to fully understand the context within which they are designing and delivering programs (Boone, Safrit, & Jones, 2002). The process of audience segmentation can serve as both a needs assessment activity and a guide for program design.

Extension has recently applied this concept to water conservation strategies. Huang, Lamm, and Dukes (2016) identified important differences among high waters users in central Florida and recommended Extension to focus on this subgroup as an important target audience separate from the general public. Warner et al. (2017) constructed behavioral profiles of national home irrigation users and identified three possible target audiences, suggesting the subgroup that was unengaged in landscape water conservation but likely to adopt comprised an important Extension audience. Monaghan, Ott, Wilber, Gouldthorpe, and Racevskis (2013) segmented residents who lived within homeowners' associations (HOAs) in central Florida, finding the HOA subgroup was less likely to use good irrigation practices.

Few behavioral studies have explored the influence of an urban or non-urban environment on pro-environmental behaviors. A worldwide study on climate change awareness found urban residents in China were more aware of climate change than rural residents but reported geographic location was not an important predictor in the United States (Lee, Markowitz, Howe, Ko, & Leiserowitz, 2015). Other researchers have identified unique and specific communication needs of urban populations for emergency communications (Lachlan, Spence, & Eith, 2013). Urban residents have been found to place less of a priority on the environment and are less engaged in conservation behaviors (Huddart-Kennedy et al., 2009) which may be a result of less exposure to green space (Shanahan et al., 2017). To date there has been little to no behavioral research evaluating the differences in water conservation practices among rural and urban audiences. This is an important area to explore as these audience segments could exhibit different priorities and levels of environmentally supportive behaviors (Huddart-Kennedy et al., 2009; Warner, Kumar Chaudhary, et al., 2017).

## Purpose and Objectives

The purpose of this study was to evaluate possible differences among Extension audiences living in urban areas with different population size in Florida. The specific objectives were to first divide Florida residents by population size, and later compare different population size subgroups based on their demographic characteristics, irrigation water sources, hiring of landscape professionals, and current engagement in water conservation practices so that impactful and tailored Extension programs can be designed.

## Methods

Data collected for this study were part of a multi-year project exploring water conservation behaviors of Florida residents over a period from 2014 to 2016. As there is no existing sampling frame of our target population (Warner et al., 2015; Warner et al., 2017), Florida residents with irrigated lawns/landscapes, we used a professional survey sampling company to secure a purposive sample using an opt-in panel, which is considered appropriate for understanding an audience when random sampling is not possible (Baker et al., 2013; Bryman, 2008). While the generalizability of non-probability samples is somewhat limited, they can produce either comparable or sometimes better results compared to probability-based samples (Abate, 1998; Twyman, 2008; Vavreck & Rivers, 2008). Over the period of three years, we secured complete responses from 3,832 out of 7,888 eligible respondents, for a completion rate of 48.6% (Baker et al., 2016). Out of completed 3,832 responses, 338 respondents were exposed to an experimental treatment in the year 2015 and were removed from further analysis. Another 18 respondents were also removed due to their non-agreement with population size coding, so final analysis sample used 3,476 responses. Prior to data collection, we secured approval from the University of Florida Institutional Review Board.

## Instrumentation and Data Collection

To determine eligibility of respondents for our target sampling frame, we used screening questions to ensure respondents were 18 years and older, had a lawn and/or landscape with irrigation, and control over irrigation of their lawn and/or landscape. Only respondents who were eligible based on these screening questions could proceed to complete the survey.

The survey had four parts. The first part of the survey asked respondents to identify their source of irrigation water using a multiple-choice question with three possible response options: *city (municipal)*, *irrigation well*, and *reclaimed water*. We also provided two additional responses: *other* and *I don't know*, which we did not include in the analysis. The second part of the survey collected information about respondents' hiring of landscape professionals for different purposes using a *select all that apply* question, where they were provided with six response options: *irrigation services*, *lawn maintenance*, *tree pruning*, *pest management*, *landscape design and installation*, and *I do not hire a landscape professional company for any services*.

In the third part of the survey, respondents reported their engagement in water conservation behaviors through 16 statements with a binary response option (*yes/no*) with an additional response option of *unsure*. These behaviors were identified through a review of landscape best



management practices promoted by Florida extension and refined by a panel of experts. The water conservation behaviors included:

- *I calibrate my sprinklers,*
- *I follow watering restrictions imposed by local government and/or water management districts,*
- *I have converted turfgrass areas to landscaped beds,*
- *I have installed smart irrigation controls (such as soil moisture sensors (SMS) or an evapotranspiration device (ET)) so irrigation won't turn on when it isn't needed,*
- *I have low-water consuming plant materials in my yard,*
- *I have replaced high volume irrigated areas with low volume irrigation,*
- *I have replaced high water plants with drought tolerant plants,*
- *I have retrofitted a portion of my landscape so that it is not irrigated,*
- *I have turned off zone(s) or capped irrigation heads for established woody plants,*
- *I seasonally adjust irrigation times,*
- *I use a rain gauge to monitor rainfall for reducing/skipping irrigation,*
- *I use a rain sensor to turn off irrigation when it is not needed,*
- *I use different irrigation zones/zone run times based on plants' irrigation needs,*
- *I use drip (micro) irrigation,*
- *I use high efficiency sprinklers, and*
- *I use recycled waste water to irrigate my lawn/landscape.*

The final part of the survey collected respondents' demographic characteristics. We measured age on a continuous scale using a drop-down list for respondents' date of birth. We captured zip codes along with information about whether respondents owned or rented their homes and belonged to a HOA. We also asked respondents to indicate the highest level of education they had completed. Finally, respondents were asked to indicate their household income.

To ensure the instrument we used for data collection provided valid inferences within the context of our study, we established face and content validity of instruments using a panel of experts (Hardesty & Bearden, 2004; Haynes, Richard, & Kubany, 1995). The panel specialized in Extension programming, agricultural and biological engineering, landscape best management practices, water conservation, and survey methodology. In addition to using a panel of experts, we pilot tested the instrument with a small number of respondents who belonged to the target audience and were not included in the full study. We made minor changes to the instrument based on recommendations from the panel of experts and the pilot test.

## **Data Analysis**

We used the United States Department of Agriculture's rural-urban continuum codes to differentiate respondents based on population size (Economic Research Service, 2013). These codes provide researchers with the ability to approach data with a more detailed analysis to identify trends related to urban proximity. They "form a classification scheme that distinguishes metropolitan (metro) counties by the population size of their metro area, and nonmetropolitan (nonmetro) counties by degree of urbanization and adjacency to a metro area or areas" (Economic Research Service, 2013, para. 1). This classification system has three metro and six

non-metro classifications. In addition to three metro areas, only one of the non-metro county designations occur in Florida, and few respondents reported living in these areas. There were adequate respondents to make robust comparisons in the non-metro county designation (non-metro areas with a population size of 20,000 or more, adjacent to a metro areas), and we excluded the few respondents living in other non-metro areas. We matched respondents' zip codes with Florida census data to segment respondents into four county population size segments:

- metro areas with a population of 1 million or more,
- metro areas with a population of 250,000 to 1 million,
- metro areas with a population of less than 250,000,
- and non-metro areas with a population size of 20,000 or more.

To examine demographic characteristics of Florida residents based on their population size, we used descriptive statistics with means and percentages by population size segment. We used chi-square analyses to differentiate these groups of Florida residents for hiring of landscape professionals, landscape irrigation water source, and engagement in water conservation behaviors based on their urban-rural area. To measure the practical significance of chi-square tests, we calculated effect sizes using Cramer's *V*, where less than 0.10 values were interpreted as negligible effect, 0.10 to 0.19 values were interpreted as a weak effect, 0.20 to 0.39 values were interpreted as a moderate effect, 0.40 to 0.59 values were interpreted as a relatively strong effect, 0.60 to 0.79 values were interpreted as a strong effect, and 0.80 to 1.00 values were interpreted as a very strong effect (Rea & Parker, 1992). We analyzed data using SPSS (version 23.0; IBM Corp., Armonk, NY).

## Results

### Demographic Characteristics

There were similarities and differences among the segments (Table 1). Florida residents in a metro area with more than one million population were youngest (45.9 years) and residents staying at a non-metro area with 20,000 or more population were oldest (53.0 years).

Table 1

*Age and year living in Florida among Florida residents segmented based on population size of areas where they live (N = 3,476)*

Demographic variable	Metro area with 1 million or more population ( <i>N</i> = 2,080) % ( <i>SD</i> )	Metro area with 250,00 to 1 million population ( <i>N</i> = 982) % ( <i>SD</i> )	Metro areas with fewer than 250,000 population ( <i>N</i> = 204) % ( <i>SD</i> )	Non metro areas with population of 20,000 or more ( <i>N</i> = 210) % ( <i>SD</i> )
Age in years	45.9 (16.0)	51.2 (16.4)	48.0 (15.8)	53.0 (17.0)
Number of years living in Florida	23.7 (15.5)	22.5 (16.1)	20.1 (14.6)	19.6 (16.0)

More than half of residents in a metro area with one million or more population (53.9%,  $n = 1,121$ ) resided in an HOA, while one third of residents in metro areas with 250,000 or less population (35.8%,  $n = 73$ ) and non-metro areas with 20,000 or more (36.2%,  $n = 76$ ) resided in an HOA. Most residents in all four segments owned their home and more than fifty percent of residents in all four areas were females. More than fifty percent of residents in metro areas with one million or more population (55.8%,  $n = 1,162$ ) had a four-year college degree or higher education, compared to only 37.2% ( $n = 78$ ) in non-metro areas with 20,000 or more population. The most common income category for residents in metro areas with one million or more was \$75,000 to \$149,99 (37.1%,  $n = 772$ ), while for other three groups the most common income category was less than \$49,999.

Table 2  
*Demographic characteristics of Florida residents segmented based on population size of areas where they live (N = 3,476)*

Demographic variable	Metro area with 1 million or more population (N = 2,080) % (n)	Metro area with 250,00 to 1 million population (N = 982) % (n)	Metro areas with fewer than 250,000 population (N = 204) % (n)	Non metro areas with population of 20,000 or more (N = 210) % (n)
HOA membership	53.9 (1,121)	43.6 (428)	35.8 (73)	36.2 (76)
Gender				
Females	56.3 (1,172)	56.7 (557)	58.3 (119)	55.7 (117)
Males	43.7 (908)	43.3 (425)	41.7 (85)	44.3 (93)
Home ownership				
Own	86.9 (1,807)	87.5 (859)	85.3 (174)	84.8 (178)
Rent	12.0 (249)	11.8 (116)	14.2 (29)	13.8 (29)
Other	1.2 (24)	0.7 (7)	0.5 (1)	1.4 (3)
Education				
Less than high school	0.3 (7)	1.0 (10)	0.5 (1)	1.4 (3)
High school/GED	11.3 (234)	14.2 (139)	15.2 (31)	22.4 (47)
Some college	19.3 (401)	26.3 (258)	19.6 (40)	27.1 (57)
2-year college degree	13.3 (276)	12.6 (124)	17.6 (36)	11.9 (25)
4-year college degree	34.8 (724)	30.1 (296)	24.5 (50)	20.5 (43)
Master's degree	15.9 (330)	13.1 (129)	16.7 (34)	12.4 (26)
Doctoral degree	2.5 (53)	1.2 (12)	2.5 (5)	0.0 (0)

Professional degree (JD, MD)	2.6 (55)	1.4 (14)	3.4 (7)	4.3 (9)
Family income				
Less than \$49,999	27.6 (574)	35.5 (349)	35.3 (72)	48.1 (101)
\$50,000 to \$74,999	25.4 (528)	25.2 (247)	28.4 (58)	24.3 (51)
\$75,000 to \$149,999	37.1 (772)	32.7 (321)	30.4 (62)	24.8 (52)
\$150,000 to \$249,999	8.3 (173)	5.6 (55)	5.4 (11)	2.4 (5)
\$250,000 or more	1.6 (33)	1.0 (10)	0.5 (1)	0.5 (1)

The residents in all four segments used city water more than any other source for irrigating their landscapes (Table 3). More residents in a metro area with one million or more (63.0%,  $n = 1,236$ ) used city (municipal) water to irrigate their landscapes while more residents in metro areas with fewer than 250,000 population used irrigation wells (43.1%,  $n = 85$ ). In all of the segments, only a small number used reclaimed water.

Table 3  
*Comparison of water source for landscape irrigation among Florida residents by segmenting residents based on population size of areas where they live (N = 3,476)*

Water source	Metro area with 1 million or more population ( $n = 1,962$ ) % ( $n$ )	Metro area with 250,00 to 1 million population ( $n = 940$ ) % ( $n$ )	Metro areas with fewer than 250,000 population ( $n = 197$ ) % ( $n$ )	Non metro areas with population of 20,000 or more ( $n = 196$ ) % ( $n$ )
City (municipal)	63.0 (1,236)	47.8 (449)	51.8 (102)	49.5 (97)
Irrigation well	21.8 (427)	36.3 (341)	43.1 (85)	39.3 (77)
Reclaimed water	15.2 (299)	16.0 (150)	5.1 (10)	11.2 (22)

Note. Pearson chi-square = 119.37,  $p < 0.001$ ; Cramer's  $V = 0.14$ . *Other* and *I don't know* responses were treated as missing data and excluded from analysis.

Residents in all four segments differed in their hiring a landscape professional for different purposes, excluding pest management (Table 4). As the population size decreased, likelihood of using a professional decreased. Residents in metro areas with one million or more population were most likely (76.0%,  $n = 1,581$ ) to hire landscape professional for any purpose, while residents in non-metro areas with 20,000 or more population were least likely (64.3%,  $n = 135$ ). The effect sizes for hiring of landscape professionals by different population areas were negligible. For specific purposes (e.g., lawn maintenance, tree pruning), the residents in metro areas with one million or more population was most likely to hire professionals for lawn maintenance (53.5%,  $n = 1,113$ ). Hiring of professionals for other three segments other than one million or more population had no specific pattern.

Table 4

*Comparison of hiring of landscape professional for different purposes among Florida residents by segmenting residents based on population size of areas where they live (N = 3,476)*

Hiring a landscape professional	Metro area with 1 million or more population (n = 2,080) % (n)	Metro area with 250,00 to 1 million population (n = 982) % (n)	Metro areas with fewer than 250,000 population (n = 204) % (n)	Non metro areas with population of 20,000 or more (n = 210) % (n)	$\chi^2$	Cramer's V
Do not hire a professional for any services	24.0 (499)	30.7 (301)	31.9 (65)	35.7 (75)	26.7**	0.09
Any purpose	76.0 (1,581)	69.3 (681)	68.1 (139)	64.3(135)	26.7**	0.09
Lawn maintenance	53.5 (1,113)	44.9 (441)	43.6 (89)	45.2 (95)	25.7**	0.09
Tree pruning	38.8 (808)	30.4 (299)	33.3 (68)	27.6 (58)	27.2**	0.09
Landscape design and installation	19.7 (409)	13.1 (129)	16.7 (34)	19.0 (40)	20.0**	0.08
Irrigation services	26.5 (552)	20.1 (197)	21.6 (44)	19.0 (40)	19.2**	0.07
Pest management	46.4 (966)	42.0 (412)	41.7 (85)	46.7 (98)	6.57	0.04

Note. \*\*  $p < 0.01$

Out of 17 water conservation behaviors, there was a significant difference in engagement in 12 behaviors (Table 5). The effect sizes for differences in water conservation behaviors among residents of four areas were negligible. For all of the significant water conservation behaviors except for use of recycled wastewater for irrigation and installation of smart irrigation controls (e.g., soil moisture sensors), the residents in non-metro areas with 20,000 or more population had highest engagement in water conservation behaviors. Almost two-thirds (62.9%,  $n = 132$ ) in non-metro areas with 20,000 or more population had replaced high volume irrigated areas with low volume irrigation areas, compared to around 45% of residents in other three areas. More than fifty percent of residents (62.9%,  $n = 132$ ) in non-metro areas with 20,000 or more population had used rain gauge to monitor rainfall for reducing/skipping irrigation, compared to around 40% in other three areas.

Table 5

*Comparison of current water conservation behaviors among Florida residents by segmenting residents based on population size of areas where they live (N = 3,476)*

Water conservation behavior	Metro area with 1 million or more population (n = 2,080) % (n)	Metro area with 250,00 to 1 million population (n = 982) % (n)	Metro areas with fewer than 250,000 population (n = 204) % (n)	Non metro areas with population of 20,000 or more (n = 210) % (n)	$\chi^2$	Cramer's V
-----------------------------	---	---	---	--	----------	------------

	% (n)		% (n)	% (n)		
I have replaced high volume irrigated areas with low volume irrigation	45.7 (950)	41.2 (405)	42.2 (86)	62.9 (132)	41.4**	0.08
I have converted turfgrass areas to landscaped beds	39.9 (829)	34.1 (335)	42.2 (86)	50.5 (106)	28.2**	0.06
I use recycled waste water to irrigate my lawn/landscape	36.6 (762)	31.4 (308)	24.5 (50)	33.3 (70)	26.6**	0.06
I have low-water consuming plant materials in my yard	65.7 (1,367)	62.2 (611)	60.8 (124)	76.2 (160)	23.1**	0.06
I use a rain gauge to monitor rainfall for reducing/skipping irrigation	38.1 (793)	37.4 (367)	39.7 (81)	52.9 (111)	22.5**	0.06
I have retrofitted a portion of my landscape so that it is not irrigated	36.3 (755)	31.2 (306)	41.2 (84)	43.3 (91)	22.5**	0.06
I have installed smart irrigation controls (such as soil moisture sensors (SMS) or an evapotranspiration device (ET)) so irrigation won't turn on when it isn't needed	30.8 (640)	23.7 (233)	25.5 (52)	30.5 (964)	21.84**	0.06
I use drip (micro) irrigation	26.2 (544)	21.2 (208)	25.5 (52)	30.5 (64)	19.7**	0.05
I follow watering restrictions imposed by local government and/or water management districts	89.8 (1,867)	91.3 (897)	83.3 (170)	92.9 (195)	17.7**	0.05
I have turned off zone(s) or capped irrigation heads for established woody plants	49.9 (1,038)	46.2 (454)	50.0 (102)	59.5 (125)	17.4**	0.05

I have replaced high water plants with drought tolerant plants	55.0 (1,143)	52.0 (511)	49.0 (100)	63.3 (133)	15.7*	0.05
I use high efficiency sprinklers	62.7 (1,305)	59.9 (588)	58.3 (119)	68.1 (143)	11.8	0.04
I use different irrigation zones/zone run times based on plants' irrigation needs	63.6 (1,323)	63.6 (625)	65.2 (133)	70.5 (148)	6.1	0.03
I seasonally adjust irrigation times	79.9 (1,661)	80.3 (789)	79.4 (162)	83.8 (176)	4.1	0.02
I calibrate my sprinklers	65.0 (1,353)	62.7 (616)	62.3 (127)	63.8 (134)	2.36	0.02
I use a rain sensor to turn off irrigation when it is not needed	51.3 (1,068)	50.1 (492)	52.5 (107)	52.9 (111)	1.40	0.01

Note. \* $p < 0.05$ , \*\* $p < 0.01$ , Numbers in table represent percentage who responded yes to current water conservation behavior. Possible responses were yes, no, and unsure.

### Conclusions and Implications

People living in different urban-rural areas are different in important ways. The most critical difference is that individuals who live in more urban areas are less engaged in water conservation than their less urban counterparts, which is consistent with Huddart-Kennedy et al. (2009). People who live in more urban areas are also less likely to be do-it-yourselfers, and are more likely to hire professionals for their landscape maintenance and related tasks. Those who live in more urban areas tend to be younger and with higher levels of education and more income. Those in more urban areas have lived in Florida for a longer period of time and are also more likely to live in HOAs. While the practical differences among the groups are somewhat small, they point to differentiated strategies that can improve the impact of Extension water conservation programs. There are also differences in the source of residents' irrigation water. As the subgroups become more urban, residents are more likely to irrigate their landscapes using municipal water. In the less urban areas, wells are more prevalent.

As the most urban audiences are least engaged in conserving water, this study highlights the importance of tailoring Extension programs to the behaviors of the urban audience. Following principles of audience segmentation, the audience with the greatest need for change that Extension programs should target are the more urban audiences (Lee & Kotler, 2011), but the traditional rural audiences should not be ignored. We agree with others who recommend Extension programs should be modified as appropriate for urban audiences and the locally-specific context without losing focus on the guiding principles of the Extension organization (Harder & Wells, 2017). Serving increasingly urban Extension audiences with relevant

programming may be a way to develop Extension advocates among a group that does not have a history of engaging with Extension (Harder et al., 2010).

Living in a more urban area could promote reduced connection to environment and natural resources. This would make sense given that urban environments provide fewer opportunities to experience nature (Shanahan et al., 2017). Extension should focus on fostering a connection to nature, especially among the most urban audiences, and help residents understand how their landscape management practices connect to local watersheds, springs, rivers, lakes, and other natural systems. While the need to provide access to green space is often highlighted as a route to increased connection to the environment and associated health benefits (Shanahan et al., 2017), access to local water bodies, or “blue space” should also be considered. Extension professionals might consider working with city and county planners to devise ways to provide exposure to and experience with local water bodies.

There is some relationship between living in a more urban location and being less engaged in landscape water conservation. Future research should explore these and other barriers that may be present in urban areas. There is also a question as to whether the practical significance among the differences we identified will increase as Florida grows more urban.

The findings point to a need to engage more partners in Extension programming for urban residents, a recommendation from our research which is consistent with the current conversation on best practices for urban Extension (National Urban Extension Leaders, 2015; Warner et al., 2017). Urban residents are more likely to live in an HOA and use a professional company for some landscape management tasks, and urban water conservation programs need to incorporate these entities which play a role in home landscape management decisions. As others have reported, HOAs may be playing some role in reducing engagement in conservation (Monaghan et al., 2013) as more HOAs correspond somehow to less conservation in more urban areas. Therefore, Extension must collaborate with HOAs, especially in the most urban areas. Similarly, urban Extension programs need to engage landscape maintenance, irrigation, tree pruning, and irrigation professionals to ensure the many influences on the home landscape are included. Utility companies are another important partner with the majority of urban residents using city water for irrigation. Water and utility bills are likely to be a good medium of communication, especially with the most urban groups. Landscape water conservation programming targeting non-metro residents needs to focus more directly on the residents, who are most likely to be doing landscape tasks themselves. Extension programs for non-metro residents could appeal to a desire to maintain private wells appropriately, while this topic would not interest more urban residents.

This study revealed new research questions that should be addressed. Florida is considerably more urban than much of the nation and we did not have a rural subgroup to use in our analysis for comparison. It is possible larger practical differences could be identified by a national study with a truly rural population size subgroup, and future research should explore this possibility. It would be advantageous to find ways to subdivide Florida residents more precisely than on a county scale and if future researchers are able to secure a random sample of different subgroups then generalizability of findings would be more appropriate



As the more urban residents are younger and have lived in the state for longer suggests more rural residents could be moving to the state later in their lives, such as upon retirement. That they are conserving more than their younger, more urban counterparts implies these new residents are bringing a water conservation ethic with them to Florida or perhaps people are moving to a more rural area upon retirement and have more time to engage in landscaping and water conservation practices.. Further research needs to be conducted to examine this possibility. Even though study results indicated non-metro residents were slightly older and more likely to manage their lawn and/or landscape individually with minimal assistance from a professional, future research is needed to explore the relationship between hiring of a professional and age of residents. Minimal or no work has segmented Extension audiences by their population size, and there is potential for this approach to inform more impactful programming across the country and across programmatic areas.

## References

- Abate, T. (1998, November 3). *Accuracy of online surveys may make phone polls obsolete*. The San Francisco Chronicle, D1. Retrieved from [www.sfgate.com/business/article/This-Election-Night-the-Internet-Could-Turn-Out-2981637.ph](http://www.sfgate.com/business/article/This-Election-Night-the-Internet-Could-Turn-Out-2981637.ph)
- Andreasen, A.R. (2006). *Social marketing in the 21st century*. Thousand Oaks, California: Sage Publications. doi:10.4135/9781483329192
- Baker, R., Brick, J. M., Bates, N. A., Battaglia, M., Couper, M. P., Dever, J. A., & Tourangeau, R. (2013). *Report of the AAPOR task force on non-probability sampling*. Retrieved from [www.aapor.org/AAPORKentico/AAPOR\\_Main/media/MainSiteFiles/NPS\\_TF\\_Report\\_Final\\_7\\_revised\\_FNL\\_6\\_22\\_13.pdf](http://www.aapor.org/AAPORKentico/AAPOR_Main/media/MainSiteFiles/NPS_TF_Report_Final_7_revised_FNL_6_22_13.pdf)
- Baker, R., Brick, J. M., Keeter, S., Biemer, P., Kennedy, C., Kreuter, F., ... Terhanian, G. (2016). Evaluating survey quality in today's complex environment. Retrieved from [www.aapor.org/AAPOR\\_Main/media/MainSiteFiles/AAPOR\\_Reassessing\\_Survey\\_Methods\\_Report\\_Final.pdf](http://www.aapor.org/AAPOR_Main/media/MainSiteFiles/AAPOR_Reassessing_Survey_Methods_Report_Final.pdf)
- Bates, B. C., Kundzewicz, Z. W., Wu, S., & Palutikof, J. P. (Eds.). (2008). *Climate change and water* (IPCC Technical Paper VI). Geneva, Switzerland: Intergovernmental Panel on Climate Change. Retrieved from <https://www.ipcc.ch/pdf/technical-papers/climate-change-water-en.pdf>
- Boone, E.J., Safrit, R. D., & Jones, L. (2002). *Developing programs in adult education: A conceptual programming model* (2nd ed.). Long Grove, IL: Waveland Press.
- Bryman, A. (2008). *Social research methods*. New York, NY: Oxford University Press.
- DeVault, G. (2016). *How Behavioral Research Relates to Market Research*. Retrieved from <https://www.thebalance.com/how-behavioral-research-relates-to-market-research-2296925>
- Economic Research Service. (2013). *Rural-urban continuum codes*. Washington, D. C.: United States Department of Agriculture. Retrieved from <https://www.ers.usda.gov/data-products/rural-urban-continuum-codes/>
- Fielding, K. S., Russell, S., Spinks, A., & Mankad, A. (2012). Determinants of household water conservation: The role of demographic, infrastructure, behavior, and psychosocial variables. *Water Resources Research*, 48(W10510). doi:10.1029/2012WR012398/full
- Harder, A., Lamm, A., & Strong, R. (2010). An analysis of the priority needs of cooperative extension at the county level. *Journal of Agricultural Education*, 50(3), 11–21. doi:10.5032/jae.2009.03011
- Harder, A., & Wells, O. (2017). Tampa Bay Extension agents' views of urban extension: Philosophy and program strategies. *Journal of Human Sciences and Extension*, 5(2), 55–69. Retrieved from [https://docs.wixstatic.com/ugd/c8fe6e\\_74f3a32b703e4a4fb0e98d2b95861a4f.pdf](https://docs.wixstatic.com/ugd/c8fe6e_74f3a32b703e4a4fb0e98d2b95861a4f.pdf)
- Hardesty, D. M., & Bearden, W. O. (2004). The use of expert judges in scale development: Implications for improving face validity of measures of unobservable constructs. *Journal of Business Research*, 57(2), 98–107. doi:10.1016/S0148-2963(01)00295-8

- Haynes, S. N., Richard, D., & Kubany, E. S. (1995). Content validity in psychological assessment: A functional approach to concepts and methods. *Psychological Assessment* 7(3), 238–247. Retrieved from [psycnet.apa.org/fulltext/1996-03400-001.pdf](https://psycnet.apa.org/fulltext/1996-03400-001.pdf)
- Huang, P., Lamm, A. J., & Dukes, M. D. (2016). Informing extension program development through audience segmentation: targeting high water users. *Journal of Agricultural Education*, 57(2), 60–74. doi:10.5032/jae.2016.02060
- Huddart-Kennedy, E., Beckley, T. M., McFarlane, B. L., & Nadeau, S. (2009). Rural-urban differences in environmental concern in Canada. *Rural Sociology*, 74(3), 309–329. doi:10.1526/003601109789037268
- Lachlan, K. A., Spence, P. R., & Eith, C. A. (2013). Risk, crisis, and emergency communication in developing countries: Identifying the needs of urban populations. In C. Okigbo (Ed.) *Strategic Urban Health Communication* (pp. 65–76). New York, NY: Springer.
- Lee, N. R., & Kotler, P. A. (2011) *Social marketing: Influencing behavior for good* (4th ed.). Thousand Oaks, CA: Sage Publications.
- Lee, T. M., Markowitz, E. M., Howe, P. D., Ko, C., & Leiserowitz, A. A. (2015). Predictors of public climate change awareness and risk perception around the world. *Nature Climate Change*, 5, 1014–1020. doi:10.1038/nclimate2728
- Mckenzie-Mohr, D. (2000). New ways to promote proenvironmental behavior: Promoting sustainable behavior: An introduction to community-based social marketing. *Journal of Social Issues*, 56(3), 543–554. doi:10.1111/0022-4537.00183
- McKenzie-Mohr, D., Lee, N. R., Schultz, P. W., & Kotler, P. (2012). *Social marketing to protect the environment*. Thousand Oaks, CA: Sage Publications.
- Monaghan, P., Ott, E., Wilber, W., Gouldthorpe, J., & Racevskis, L. (2013). Defining audience segments for extension programming using reported water conservation practices. *Journal of Extension*, 51(6). Retrieved from <https://www.joe.org/joe/2013december/a8.php>
- National Resource Defense Council. (2010). *Climate Change, Water, and Risk: Current Water Demands Are Not Sustainable*. Retrieved from <https://www.nrdc.org/sites/default/files/WaterRisk.pdf>
- National Urban Extension Leaders. (2015). *A national framework for urban Extension*. Retrieved from [http://media.wix.com/ugd/c34867\\_668cd0780daf4ea18cb1daddad557c72.pdf](http://media.wix.com/ugd/c34867_668cd0780daf4ea18cb1daddad557c72.pdf)
- Rea, L. M., & Parker, R. A. (1992). *Designing and conducting survey research*. San Francisco, CA: Jossey-Boss.
- Rogers, E. M. (2003). *Diffusion of Innovations* (3rd ed.). New York, NY: Free Press.
- Ruemenapp, M. A. (2017). America's changing urban landscape: Positioning extension for success. *Journal of Human Sciences and Extension*, 5(2), 6–21. Retrieved from [https://docs.wixstatic.com/ugd/c8fe6e\\_c21b1537d418462c8338738296d9b586.pdf](https://docs.wixstatic.com/ugd/c8fe6e_c21b1537d418462c8338738296d9b586.pdf)
- Shanahan, D. F., Cox, D. T. C., Fuller, R. A., Hancock, S., Lin, B. B., Anderson, K. ... Gaston, K. J. (2017). Variation in experiences of nature across gradients of tree cover in compact and sprawling cities. *Landscape and Urban Planning*, 157, 231–238. doi:10.1016/j.landurbplan.2016.07.004
- St. Hilaire, R., Arnold, M. A., Wilkerson, D. C., Devitt, D. A., Hurd, B. H., Lesikar, B. J., ... Zoldoske, D. F. (2008). Efficient water use in residential urban landscapes. *HortScience*,

- 43(7), 2081–2092. Retrieved from  
[https://www.researchgate.net/profile/Robert\\_Morris12/publication/241704994\\_Efficient\\_Water\\_Use\\_in\\_Residential\\_Urban\\_Landscapes/links/55b7c83308ae9289a08c1611.pdf](https://www.researchgate.net/profile/Robert_Morris12/publication/241704994_Efficient_Water_Use_in_Residential_Urban_Landscapes/links/55b7c83308ae9289a08c1611.pdf)
- Tiffany, J. S. (2017). Extension in the City: Meeting the challenges of scale. *Journal of Human Sciences and Extension*, 5(2), 37–54. Retrieved from  
[https://docs.wixstatic.com/ugd/c8fe6e\\_d7d56653662f4013a7e9826dd5180ff3.pdf](https://docs.wixstatic.com/ugd/c8fe6e_d7d56653662f4013a7e9826dd5180ff3.pdf)
- Twyman, J. (2008). Getting it right: Yougov and online survey research in Britain. *Journal of Elections, Public Opinions and Parties*, 18(4), 343–354.  
doi:10.1080/17457280802305169
- U.S. Census Bureau. (2010). *2010 Census urban area facts*. Retrieved from  
<https://www.census.gov/geo/reference/ua/uafacts.html>
- University of Florida / Institute of Food and Agricultural Sciences (2013). *Shaping solutions for Florida's future: The UF/IFAS extension roadmap 2013 – 2023*. Retrieved from  
<http://extadmin.ifas.ufl.edu/media/extadminifasufledu/agentx2fspecialist/docs/lrp2.pdf>
- Vavreck, L., & Rivers, D. (2008). The 2006 cooperative congressional election study. *Journal of Elections, Public Opinion and Parties*, 18(4), 355–366. doi:10.1080/17457280802305177
- Warner, L. A., Kumar Chaudhary, A., Rumble, J. N., Lamm, A. J., & Momol, E. (2017). Using audience segmentation to tailor residential irrigation water conservation programs. *Journal of Agricultural Education*, 58(1), 313–333. doi:10.5032/jae.2017.01313
- Warner, L. A. & Lamm, A. J. (2017). Understanding residential irrigation users to target water conservation extension programs. *Journal of Extension*, 55(3). Retrieved from  
<https://www.joe.org/joe/2017june/rb4.php> (8 pages)
- Warner, L. A., Rumble, J. N., Martin, E., Lamm, A. J., & Cantrell, R. A. (2015). The effect of strategic message selection on residents' intent to conserve water in the landscape. *Journal of Agricultural Education*, 56(4), 59–74. doi:10.5032/jae.2015.04059
- Warner, L. A., Vavrina, C. S., Campbell, M. L., Elliott, M. L., Northrop, R. J., & Place, N. T. (2017). A strategic plan for maintaining relevancy among clientele through urban Extension in Florida. *Journal of Extension*, 55(3). Retrieved from  
<https://www.joe.org/joe/2017june/a1.php>

# **Developing 21<sup>st</sup> Century Leadership Skills in County Extension Directors: Exploring Design, Implementation and Evaluation of an Online Leadership Development Program**

Matthew Sowcik, University of Florida  
Matt Bengel, University of Florida  
Jera Niewoehner-Green, Ohio State University

## **Abstract**

County Extension Directors (CED) are tasked with a myriad of responsibilities, many of which are directly related to leadership skills. Despite the identification of competencies and skills needed by CEDs in order to maintain successful programs, little research has been conducted on actual Extension leadership programming. Even more uncommon in the literature is the evaluation of CED leadership development programs that utilize online delivery. Thus, the purpose of this study was to explore the outcomes of a primarily online leadership development program with the goal of developing 21<sup>st</sup> century soft skills in CEDs. The Leadership Short Course was built upon the leadership development foundations of Moore and Rudd (2004), Owen (2004) and Sanders (2014), while the program evaluation framework utilized the Kirkpatrick (1976) model to evaluate program participant reactions, learning, and behavior changes. Key findings indicate that the design and delivery of the program resulted in high participant satisfaction and significant increases in leadership knowledge and skill level. Positive outcomes in this type of online programming has implications for the design and implementation of future CED leadership programs.

## **Introduction**

Leadership development programs are a recognized way to increase an individual's capacity to address unforeseen problems, initiate change, or effectively engage in the process of leading others (Day, 2000; McKee, Odom, Moore, & Murphrey, 2016). These programs are critical to the success of County Extension Directors (CEDs) who provide leadership at the local level with regards to developing and implementing programs, managing budgets, addressing stakeholders needs, attending to policy, and serving as the link between Extension agents and upper levels of Extension administration (Jayaratne, Owen & Jones, 2010; Sanders, 2014). Furthermore, the anticipated challenge of replacing a large number of CEDs in the future, due to the retirement of the baby boomer generation, highlights the importance of having effective leadership programs established to develop the needs of new leaders. (Jayaratne, Owen & Jones, 2010; Moore & Rudd, 2005). As a system that primarily promotes from within (Jayaratne, Owen & Jones, 2010; Moore & Rudd, 2005), internal programming can aid in cultivating and sustaining effective leadership.

It is commonly recognized that developing the competencies and skills of CEDs is a critical priority for Extension (Jayaratne, Owen & Jones, 2010), yet few CEDs have the leadership competencies needed to be effective in their administrative position (Sanders, 2014). This may be due to a number of factors impacting the successful design and implementation of CED leadership development programs. First, research from Campbell, Grieshop, Sokolow and Wright (2004) suggests that CEDs are inadequately supported in their leadership roles.

Additionally, as funding is cut or restricted, often the first programs to be eliminated include those associated with professional development. Finally, leadership development often competes against other tasks with greater perceived importance as CEDs try to manage the various demands on their time. This, once again, puts the development of CED leadership skills on the back burner.

An increasing need for systematic evaluation of leadership programs to measure and communicate the program's worth places added pressure on Extension CEDs to make sure their resources are being utilized effectively. As Jayaratne, Owen, and Jones (2010) point out, "when resources are scarce and funding agencies are demanding program impacts for accountability, the demand for evaluation is obvious" (p.18). However, few leadership programs in general are evaluated and even fewer programs publish their findings so others in the field can learn and build off their results. This is especially true concerning Cooperative Extension based leadership programs, where a dearth in the research exists. The Agricultural Education National Research Agenda (2016) emphasizes the importance for agricultural educators to "determine the most effective means for incorporating and assessing soft skills development in both formal and nonformal settings" (p.30). The authors of this paper aim to contribute to the current base of research on Extension-based leadership development programs by exploring the design, delivery, and evaluation of an online CED leadership program designed to develop 21<sup>st</sup> century leadership skills.

### **Conceptual Framework**

Over the past 50 years in Extension research there has been an interest in the leadership skills critical for a County Extension Directors success. In 1977, Rogers completed a dissertation examining the competencies critical to the administrative role of the County Extension Chairman. In the study, Rodgers found that four administrative functions: personnel management, program management, financial management, and office management, were important to the role of Georgia County Directors. Additionally, Rodgers identified 28 unique managerial competencies that corresponded with the four administrative areas such as communication, motivating, problem-solving, leading, planning, relationship building, and establishing work flow to name a few. Ten years later, the Georgia Extension Service conducted a study of skills essential to performing the managerial role of county directors (White & Bachtel, 1987). Of the 34 skills found in the study, the 10 most important skills for CED success included communicating, public relations, leading, planning, establishing and maintaining a good office image, budget accountability, decision making, evaluating, staff support, and motivating others.

As evidenced in more recent Extension research, similar skills have been associated with leadership competence. Moore and Rudd's (2004) study identified six leadership skill levels of senior Extension leaders: human, conceptual, technical, communication, emotional intelligence, and industry knowledge skills. In addition, Owen (2004) studied CEDs from North Carolina Cooperative Extension and found 38 sub-competencies that were important to CED long-term success, such as interpersonal relationships, emotional intelligence, conflict management, and understanding self and others. Most recently, Sanders (2014) completed a study examining the

leadership competencies and needs of CEDs in Florida Extension. In this research, Sanders (2014) points out:

The majority of CED professional development needs focus on human skills. These include conflict resolution, saying no when warranted, time management, listening, creating a supportive work environment, and relationship building. The highest priority conceptual skills for professional development programming include extension marketing, change implementation, and visioning. (p. 134)

Although this research has helped those in Extension better understand the skills and competencies critical to CED leadership success, the research into programs developing these skills, including program design, implementation and evaluation, is rare. One example comes from the research of Jayaratne et al. (2010) exploring a new and aspiring CED leadership education program. Utilizing both qualitative and quantitative analysis, the authors examined how the design and delivery of a leadership education program helped build CED leadership skills and behaviors. Recommendations from the research included more hands-on activities, team building exercises, problem solving sessions and a shorter time frame than nine months.

Even more uncommon in the literature is evaluation of CED leadership development programs that utilize online delivery. However, these types of programs are critically important for a few reasons. As Hall and Broyles (2015) suggest, “State Cooperative Extension budgets are tight and Extension administrators are looking for ways to compensate for reductions in funding” (p. 197). Therefore, an online leadership development program can reduce the cost associated with travel expenses and training materials. Additionally, CEDs have numerous demands on their time and often find it difficult to juggle all of their different roles (Sanders, 2014). Finding time to travel to a training and dealing with the demands of an inflexible training schedule often requires CEDs to eliminate these developmental opportunities for the good of their primary responsibilities. Online training, however, requires no additional travel time and provides an asynchronous program design.

### **Evaluation Framework**

It is important to provide a systematic evaluation of agricultural leadership development programs to justify the costs and resources associated with the program delivery to key stakeholders (McKee, Odom, Moore, & Murphrey, 2016). Evaluation also provides an opportunity to address feedback and make needed changes to increase the leadership program’s future success. One of the most extensively used approaches to evaluate leadership development programs is Kirkpatrick’s four ‘levels’ of criteria (1976). These four levels of training outcomes include:

- Level 1: Reaction – This level assesses the participants’ reaction to the leadership development program. Reaction questionnaires are most often utilized to measure participants’ affective responses to the training. This can include satisfaction with the training facilitator, content or the program overall;
- Level 2: Learning – At this level, participants’ learning is measured, based on changes in a participant’s knowledge, attitudes, skills, confidence or commitment. This change is

driven by the goals and objectives outlines in development of the program. Level 2 can be assessed by utilizing performance tests or pre-post assessments;

- Level 3: Behavior – In the model, level three assesses changes that happen in participants’ behavior on the job and the extent to which learning from the program has been applied to the participants’ jobs. Evaluation is completed through the use of observation, interviews, or collecting productivity data; and
- Level 4: Results – The final level assesses the impact the development program has had on the bottom-line of the broader organizational goals. The methods for assessment include measuring costs, quality, retention, and return on investment (ROI).

There are a few reasons the Kirkpatrick model has been utilized as a primary tool for evaluating leadership development programs over the past three decades (Bates, 2004). First, the model presents evaluation in a systematic way, which provides numerous data points. These different measures can also be utilized to address a diverse set of stakeholders’ interests (Bates, 2004). Finally, the model simplifies the complex process of leadership program evaluation. By dictating particular questions to address specific criteria and limiting the demands of numerous measurement points, the Kirkpatrick model streamlines the evaluation process (Bates, 2004).

Although the Kirkpatrick model is both a popular and straightforward evaluation tool, typically programs only target the two lower levels of the model. According to Kirkpatrick and Kirkpatrick (2016), approximately 58 percent of online programs measure level one, while level three is only measured 17 percent of the time. Furthermore, even when levels three and four are being assessed, the measures and questions used are more appropriate for level one outcomes (Kirkpatrick, & Kirkpatrick, 2016). More extensive evaluation at levels three and four provide an opportunity to collect valuable data that can be used by the organization to address organizational goals determine what programming elements add significant value.

### **Description of Program**

Taking into account the general literature on CED leadership skills and focusing more specifically on the findings of Moore and Rudd (2004), Owen (2004) and Sanders (2014), the leadership development program offered leadership sessions that explored: (a) role of the leader; (b) leader identity; (c) building strong relationships with others; (d) creating an extraordinary leadership environment (e) best practices in leadership; and (f) continued leadership learning. The specific topics covered in these sessions are outlined in Table 1.

Based on participant feedback and suggestions to further improve the leadership program, Jayaratne, Owen and Jones (2010) recommended after conducting their CED leadership program to condense the overall length of the program from nine to four months. Keeping this in mind, the Leadership Short Course extends over three months while also providing two weeks between developmental sessions to encourage participants to practice what they learned during each session. The first five sessions were delivered online, while the final session was delivered in a face-to-face format reviewing the participants’ 360 evaluations. Program participants received a leadership program certificate for completion of the course.



Table 1

*Session Titles and Descriptions of the Leadership Short Course*

Session Title	Sections Covered in the Session
Roles of a Leader	Understanding the power of perception; establishing purpose; defining leadership priorities
Leader Identity	Developing humility, optimism, and continued learning mindset; appreciating differences (Myers Briggs Type Indicator personality inventory), understanding the power of emotions
Building Strong Relationships with Others	Authentic communication; conflict resolution and stress management
Creating an Extraordinary Leadership Environment	Reframing leadership; accountability and discipline; creating a culture of change
Leadership Best Practices	Cultivating creativity; teamwork and psychological safety; providing feedback and recognition
Developing a Leadership Development Plan	360-degree feedback

**Purpose and Objective**

The purpose of this study was to explore the outcomes of a primarily online leadership development program with the goal of developing 21st century soft skills in CEDs. The research objective was to evaluate participants’ satisfaction, learning outcomes, and behavior changes from the Leadership Short Course.

**Methodology**

The Leadership Short Course took place from February through April, 2017. The target audience for program participation was Florida County Extension Directors. Program participants were selected via nomination from his/her District Extension Director. Selected participants were characterized as emerging leaders, risk takers, and exhibiting enthusiasm to advance themselves and UF/IFAS Extension. Out of 64 Florida CEDs, twenty-two were nominated and began the course; however, program participants were expected to stay engaged and complete the assignments, otherwise they would be removed from the course. Five program participants were removed during the first quarter of the course, ending with a program cohort completion rate of 77% ( $n = 17$ ). Table 2 provides a brief description of final program cohort participants.

Table 2  
*Characteristics of Participants*

	<i>f</i>	<i>%</i>
Years working in Extension		
1-5 years	8	47%
6-10 years	3	18%
11-15 years	2	12%
16 years or more	4	23%
Years serving as a County Extension Director		
1-5 years	14	82%
6-10 years	2	12%
11-15 years	1	6%
Held a leadership position prior to joining Extension		
Yes	13	77%
No	4	23%

Two instruments were created to satisfy Kirkpatrick's (1976) levels of training outcomes, both of which were sent via Qualtrics. The items and open-ended questions stemmed from the program objectives of the Leadership Short Course. Only the first three levels of the model were evaluated for this study, as not enough time had passed to satisfy the criteria of level four outcomes. The first instrument concentrated on the first two levels: reactions and learning outcomes. There were 17 statements pertaining to the learning outcomes using a retrospective pretest and a traditional posttest. Retrospective pretests asked respondents to recall their perceptions prior to engaging in the treatment at the same time they evaluate their perceptions after completing the treatment (Pratt, McGuigan, & Katzev, 2000). The next 10 statements pertained to their reactions to the online course format and satisfaction. The second instrument evaluated the third level, behavior change, using a mixed methods approach. The first 21 statements regarded whether the participants have seen a change in their own leadership competencies and how often they use the competencies developed from the program. Several open-ended questions solicited more detailed input from respondents.

An expert panel was used to establish the instrument's face and content validity. The selected experts were chosen based on proficiency in program evaluation and leadership development. Following the completed program evaluation, the researchers calculated post-hoc reliability for each level of evaluation using Cronbach's alpha. Level one had a Cronbach's alpha of 0.87, level 2 had a Cronbach's alpha of 0.94, and level three had a Cronbach's alpha of 0.87. All three levels of evaluation were deemed reliable as all were above the 0.70 alpha level as noted by Cronbach (1971).

Using SPSS 24.0, data were analyzed using descriptive and inferential statistics for the first instrument and part of the second instrument to analyze the Likert-type scale statements. The constant comparative method (Merriam, 1998) was used to reduce data from the open-ended questions into identifiable, recurring themes (Lincoln & Guba, 1985). An audit trail was maintained throughout the data analysis, while direct quotes from respondents were used to

create a thick description of the findings. Bias from the researchers can affect the way qualitative data is analyzed and interpreted. For the study reported here, one of the researchers is a state specialist with prior experience in Extension. The other two researchers are state specialists with expertise in leadership development.

The researchers followed the Tailored Design Method (TDM) by Dillman, Smyth, and Christian (2009). The TDM is described as “using multiple motivational features in compatible and mutually supportive ways to encourage high quantity and quality response to the surveyor’s request” and yields high response rates, reduces sampling error, develops trust with the respondents, and allows the researcher to follow survey procedures that are scientifically founded (Dillman et al., 2009, p. 16). IRB approval was received prior to executing the program. Qualtrics was the mode of delivery chosen for the online questionnaires. The advantages to using an online survey for this study were low cost, anonymity, quick response time, and ease of distribution and submission (Ary et al., 2006; Dillman et al., 2009). The first survey, which was sent one week after the program ended, yielded a response rate of 100% ( $n = 17$ ). The second survey, which was sent 6 months after the program ended, yielded a responses rate of 88% ( $n = 15$ ).

## Findings

### Level One Results

Respondents indicated a high level of satisfaction with the online-delivery format (Table 3). Participants indicated their highest level of satisfaction with the communication from the instructor ( $M = 4.76$ ,  $SD = 0.44$ ) and engagement of the instructor ( $M = 4.71$ ,  $SD = 0.47$ ). Reichheld (2003) suggests that one of the most significant measures of satisfaction and growth can be measured by a “would recommend” question. As Reichheld suggests, “By asking this one question, you collect simple and timely data that correlate with growth. You also get responses you can easily interpret and communicate” (2003, p. 1). The participants reported they would participate in a similar type of training program in the future ( $M = 4.53$ ,  $SD = .87$ ) and recommend this program to a colleague ( $M = 4.71$ ,  $SD = .59$ ) (Table 4).

Table 3  
*Participants’ Satisfaction of the Leadership Short Course*

	<i>M</i>	<i>SD</i>
Overall course satisfaction	4.41	.62
Organization of online modules	4.41	.71
Navigation of online modules	4.29	.85
Engagement of the online modules	4.47	.51
Content of online modules	4.35	.49
Flexibility of the course	4.41	.80
Course deadlines	4.13	.81
Course work (assignments)	4.00	.71
Engagement of the instructor	4.71	.47
Communication from the instructor	4.76	.44

*Note.* Respondents were asked to rate their level of satisfaction about the course on a Likert-type scale (1 = *Very dissatisfied*, 2 = *Dissatisfied*, 3 = *Neither satisfied nor dissatisfied*, 4 = *Satisfied*, 5 = *Very satisfied*).

Table 4

*Participation in Future Online-Delivered Programs and Recommendations to Colleagues*

	<i>M</i>	<i>SD</i>
I would participate in training programs like this one in the future	4.53	.87
I would recommend this program to my colleagues	4.71	.59

*Note.* Respondents were asked to rate their level of agreement with the above statements on a Likert-type scale (1 = *Strongly disagree*, 2 = *Disagree*, 3 = *Neither agree nor disagree*, 4 = *Agree*, 5 = *Strongly agree*).

**Level Two Results**

Respondents indicated significant changes in many of their leadership skills after completing the Leadership Short Course (Table 5). The three leadership skills with the most significant changes were understanding the importance perceptions play in leadership development,  $t(16) = 4.66$ ,  $p < 0.05$ , understanding the role environment plays in leadership,  $t(16) = 3.66$ ,  $p < 0.05$ , and recognizing the importance of experience on both perception and leadership,  $t(16) = 3.50$ ,  $p < 0.05$ .

Table 5

*Paired Means and Statistical Significance of Leadership Skills*

Leadership Skills	Before		After		<i>t</i>	<i>p</i>
	<i>M</i>	<i>SD</i>	<i>M</i>	<i>SD</i>		
Understand the importance perceptions play in leadership development	3.47	.72	4.35	.70	4.66	.00
Recognize the role purpose plays in leading others	3.59	.62	4.12	.70	2.3	.03
Recognize the importance of experience on both perception and leadership	3.53	.72	4.06	.66	3.50	.01
Identify the difference between primary and secondary dimensions of diversity	3.24	.97	3.71	.99	2.22	.04
Compare and contrast your personality type to others	3.59	1.07	4.53	.62	3.11	.01
Identify my overconfidence and optimism bias	3.25	.86	3.69	.95	1.39	.19
Recognize factors associated with effective communication	3.71	.92	4.24	.83	2.31	.03
Recognize the different dimensions of emotional intelligence	3.18	.11	3.82	.95	2.40	.03
Utilize different approaches to conflict resolution	3.06	.93	3.94	.68	3.05	.01
Understand the role environment plays in leadership	3.31	.70	4.19	.83	3.66	.00
Recognize the different frames of organizational perspective	2.71	.99	3.59	1.00	3.45	.01

Identify costs and benefits to conflict in organizations	3.18	.95	3.94	.43	2.62	.02
Analyze the barriers to change in organizations due to particular organizational frames	2.88	1.05	3.82	.53	3.11	.01
Recognize factors associated with effective email communication	3.65	.79	4.06	.56	1.60	.13
Understand the importance of recognizing others	4.12	.78	4.59	.62	2.06	.06
Identify elements of building an effective team	3.53	.72	4.24	.67	2.95	.01
Recognize the different steps to running an effective meeting	3.59	.80	4.18	.64	2.58	.02

*Note.* Respondents were asked to rate their knowledge level of leadership concepts and ability to apply them before and after participating in the Leadership Short Course on a Likert-type scale: (1 = *Very low*, 2 = *Low*, 3 = *Average*, 4 = *High*, 5 = *Very high*).

### Level Three Results

Overall, respondents reported moderate to high levels of behavior change from their participation in the Leadership Short Course (Table 6). The highest levels of behavior changes reported were their perception of their leadership role ( $M = 3.20$ ,  $SD = 1.03$ ), providing feedback ( $M = 3.17$ ,  $SD = 1.03$ ), paying attention to different personality types ( $M = 3.07$ ,  $SD = 0.92$ ), placing importance on understanding and appreciating differences ( $M = 3.00$ ,  $SD = 1.00$ ), and cultivating creativity ( $M = 3.00$ ,  $SD = 1.29$ ).

Table 6  
*CED Behavior Changes Six Months after Completion of Leadership Short Course*

	<i>M</i>	<i>SD</i>	<i>N</i>
The perception I have of my leadership role	2.36	0.81	11
The priority I place on leadership related activities	2.58	1.08	12
The amount of time I take to coach others	3.20	1.03	10
The importance I place on understanding and appreciating differences	3.00	1.00	13
The attention I pay to different personality styles in leading others	3.07	0.92	14
Being aware of my overconfidence or over optimism	2.27	1.01	11
Am more emotionally in control of thoughts and actions	2.27	0.79	11
Handle conflict more effectively	2.29	0.76	7
Better understand the role the environment plays in my leadership effectiveness	2.67	0.866	9
Use the different frames to help lead more effectively	2.13	1.25	8
Ask for conflicting ideas to get to better solutions	2.63	1.19	8
Use critical thinking (including the frames) to address problems in the organization	2.89	1.17	9
Write more effective emails	2.50	1.00	12
Communicate with others more effectively	2.58	0.90	12

Work with teams more effectively	2.58	1.08	12
Run more effective meetings	2.64	1.12	11
Cultivate creativity	3.00	1.29	7
Encourage psychological safety	2.89	1.05	9
Provide feedback to others	3.17	1.03	12
Provide recognition	2.85	0.98	13
Work on particular leadership competencies	2.75	0.97	12

*Note.* Respondents were asked to rate the degree to which their behavior has changed due to their participation in the Leadership Short Course on a Likert-type scale (1 = *Not at all*, 2 = *A moderate amount*, 3 = *A lot*, 4 = *A great deal*).

Respondents were asked what had been the biggest difference with their ability to lead as a result from their participation in the Leadership Short Course. Ninety-three percent ( $n = 14$ ) of respondents provided an explanation. Increased confidence ( $n = 3$ ) and communication ( $n = 3$ ) were common themes reported, such as “less trepidation to assume a leadership role in my office and with colleagues” and “listening to staff concerns, prioritizing, and making decisions for the greater good of the department”. Another respondent stated, “my willingness to accept different opinions and different ways of doing things; using the differences to make better decisions for the entire office”.

Finally, respondents were asked if their confidence level had changed due to their participation in the Leadership Short Course. Eighty-seven percent ( $n = 13$ ) of respondents reported a change in their confidence to lead. When prompted to describe in what ways their confidence changed, respondents replied “I feel that I am paying better attention to others, so when I make a decision, it is more applicable to everyone” and “I feel more comfortable and take the time to let people know I appreciate them”. Another respondent stated, “I feel more confident in communicating now that I know the communication preferences of my team members. Knowing this info allows me to tailor my message to my audience”.

## Conclusions

It is critically important to find innovative ways to deliver and develop the skills and behaviors of County Extension Directors in the area of leadership. Though there are leadership development programs, which assume this responsibility, the research on the success of these programs is scarce. This paper is the first to look at the design and evaluation of a primarily online CED leadership program. The Kirkpatrick model (1976) of program evaluation was used to better understand the impact the program had on participants.

Kirkpatrick’s first level measures participant satisfaction with the different course components. Overall, the participant were satisfied in all areas evaluated. The highest level of satisfaction from participants were in the areas of engagement with instructor and communication from instructor. In face-to-face training, the variability that could emerge based on the particular instructor would be concerning. However, one of the strengths of an online format is that most engagement and communication was made using videos, emails and postings, which can be replicated in all future courses guaranteeing consistency.

The high level of engagement in the class also likely impacted other ratings of satisfaction. Although the participants' responses were still in the satisfied range, the participants rated course work/assignments and course deadlines as the two lowest levels of participant satisfaction. Based on the qualitative responses, this was related to the short time frame the participants had to complete assignments rather than the difficulty or dissatisfaction with the assignments. However, these findings are inconsistent with participant's views concerning the length of time for program delivery. The current program utilized a three-month timeframe to deliver course content via online and face-to-face following Jayaratne et al.'s (2010) recommendation for limiting leadership development programs to less than four months. When asked about whether the course should be kept the same length, shortened, or increased, 59% ( $n = 10$ ) of respondents reported the program length was satisfactory. Twenty-nine percent ( $n = 5$ ) reported shortening the course length, and 12% ( $n = 2$ ) recommended increasing the program length.

Participants in the Leadership Short Course reported a high likelihood they would recommend the program to colleagues. Since the program is still in its infancy, the recommendations from these early adopters will be critically important to the recruitment success of future cohorts. Additionally, participants in the program suggested they would be likely to participate in a program like this in the future. This may have implications on additional leadership training opportunities and CED training in general. Finally, both of these quantitative results can be used to provide stakeholders with both satisfaction data on the course and the likelihood additional cohorts could be recruited using participant recommendations (Reichheld, 2003).

A retrospective pretest and a traditional posttest was used to measure the change in attitudes, knowledge, and skills learned by the participants of the Leadership Short Course. There was a significant increase in fourteen of the seventeen statements measuring perceived participant learning throughout the program. The learning that occurred during the program was the first step to transferring the competencies back into the work environment (Kirkpatrick & Kirkpatrick, 2016). Although seventy-seven percent of the participants held a leadership position prior to joining Extension, the learning of new perspectives and leadership tools could have aided the CEDs in feeling more confident, which was reported as a behavior change in the six-month behavior change survey.

The third level of evaluation that was completed addressed the changes to the CEDs behavior six months after the leadership program was completed. Based on the findings of the six-month post survey, it is evident the leadership development program had an impact on CED leadership behavior. All of the 21 behavior changes that were measured displayed significant increases from respondents. The strongest impact can be seen in the CED behavior of coaching and providing feedback, indicating the program is having an impact on both the behaviors of the CEDs and also the Extension agents they supervise. The majority of respondents also indicated they saw an increase in their confidence to lead, and their communication styles changed according to which styles their team members prefer, both of which were identified by both Owen (2004) and Sanders (2014) as important competencies for CEDs to possess.

When comparing the level two learning outcomes to the level three behavior changes, differences emerged among two of the evaluation statements. First, *identify my overconfidence and optimism bias* was rated low from both levels two and three, providing important feedback

about this particular section of the course. Moving forward, this section will need to be revised for both initial learning and post-training transfer. Second, *recognize the different frames of organizational perspective* was rated high ( $M = 3.59$ ) in the post training learning evaluation but these tools did not transfer into new behaviors on the job. This will also need to be re-evaluated and more focus should be placed on helping participants take what they have learned and apply it to their leadership opportunities.

### **Implications and Recommendations**

The study explores the impact of an online leadership program on Florida CEDs' satisfaction, learning, and behavior change. The results suggest three major implications for extension, online leadership development, and program evaluation. As Sondgerath (2016) suggests, "With Cooperative Extension budgets shrinking at federal, state, and local levels, it is incumbent on state Extension systems to explore innovative ways of delivering professional development content as efficiently as possible while still providing content relevant to field educator/agent needs." The first implication of this study is that online leadership programs can provide an innovative way to address the leadership developmental needs of CEDs, while also providing increased flexibility in participation and cost saving associated with travel expenses.

A second implication of the current study is the contribution it makes to the body of research pertaining to online leadership development program evaluation. The research provides a template to measure outcomes associated with participant satisfaction, learning, and behavior changes. This research also contributes to the scarce literature on Kirkpatrick's third level of evaluation, addressing CED behavior change six months after the online leadership program concluded. With this said, this study also provides valuable insight into level two and three outcomes, which need to be adapted in order to demonstrate better increases in specific sections.

The final implication of this current study includes the overall satisfaction, learning and behavior change results of the program. The day-to-day leadership responsibilities of a CED, along with the changing landscape of Extension, have presented new leadership challenges for CEDs to overcome (Sanders, 2014). Previous research suggests that very few Extension leaders have the leadership competence appropriate for today's Extension organization (Sanders, 2014; Ladewig & Rohs, 2000). Additionally, "several studies have shown that Extension professionals perceive their own management abilities as deficient," which can have a negative impact on leader self-confidence (Sondgerath, 2016). The online Leadership Short course demonstrates results that address CED satisfaction with the training, perceived learning to impact leader self-confidence, and actual behavior change on different leadership competencies.

As Extension explores the option of online leadership development, there are also a few recommendations that should be considered when conducting future research on CED online leadership development programs. First, more research is needed examining online leadership development programs, specifically observing different program structures and in other contexts. The current research is limited due to the participants studied being CEDs from a single state's Extension system. The second recommendation is to examine the impact these programs have on those who are supervised by CEDs. With the program encouraging the most significant changes in coaching and feedback, it would seem the program also had an impact on the Extension agents supervised by the course participants; however, the course evaluations did not include this audience. Future course evaluations should include an instrument for supervisees to measure



perceived changes to program participant behaviors related to key leadership skills addressed in the online program. The third recommendation is to explore the impact the online program had on the UF/IFAS Extension system, which is also the criteria for level four evaluation under Kirkpatrick's model (1976).

## References

- Ary, D., Jacobs, L., C., Razavieh, A., & Sorensen, C. (2006). *Introduction to research in education* (7th ed.). Australia, Thompson-Wadsworth.
- Bates, R. (2004). A critical analysis of evaluation practice: The Kirkpatrick model and the principle of beneficence. *Evaluation and Program Planning*, 27(3), 341-347.
- Campbell, D., Grieshop, J., Sokolow, A. & Wright, J. (2004). Supporting the critical administrative leadership role of county directors. *Journal of Extension*, 42(2). Retrieved from <https://www.joe.org/joe/2004april/a3.php>
- Cronbach, L. J. (1971). Test validation. In R. L. Thorndike, W. H. Angoff & E. F. Lindquist (Eds.), *Educational measurement* (2nd ed). Washington, DC: American Council on Education. Cohen, J. (1988). *Statistical power analysis for the behavioral sciences* (2<sup>nd</sup> ed.). New York: Academic Press.
- Day, D. (2000). Leadership development: A review in context. *The Leadership Quarterly*, 11(4), 581-613.
- Dillman, D. A., Smyth, J. D., & Christian, L. M. (2009). *Internet, mail, and mixed-mode surveys: The tailored design method* (3rd ed.). Hoboken, New Jersey: John Wiley & Sons, Inc.
- Hall, J. L., & Broyles, T. W. (2015). Leadership competencies of Tennessee Extension agents: Implications for professional development. *Journal of Leadership Education*, 15(3), 187-200.
- Jayaratne, K. S. U., Owen, M., & Jones, D. (2010). Evaluating a new and aspiring county Extension director leadership education program: Determining outcomes and needed improvements. *Journal of Leadership Education*, 9(1), 17-35. Retrieved from [http://www.journalofleadershiped.org/attachments/article/171/JOLE\\_9\\_1\\_Jayaratne\\_Owen\\_Jones.pdf](http://www.journalofleadershiped.org/attachments/article/171/JOLE_9_1_Jayaratne_Owen_Jones.pdf)
- Kirkpatrick, D. L. (1976). Evaluation of training. In R. L. Craig (Ed.), *Training and development handbook: A guide to human resource development* (2nd ed., pp. 87-112). New York: McGraw-Hill.
- Kirkpatrick, J. D., & Kirkpatrick, W. K. (2016). *Kirkpatrick's four levels of training evaluation*. Alexandria, VA: Association for Talent Development.

- Lincoln, Y. S., & Guba, E. G. (1985). *Naturalistic inquiry*. Newbury Park, CA: Sage.
- McKee, V. L., Odom, S. F., Moore, L. L., & Murphrey, T. P. (2016). Impacts of an agricultural leadership Extension program for county officials. *Journal of Agricultural Education*, 57(4), 202-216. doi: 10.5032/jae.2016.04202
- Merriam, S. B. (1998). *Qualitative research and case study applications in education*. San Francisco: Jossey-Bass.
- Moore, L. L., & Rudd, R. D. (2005). Extension leaders' self-evaluation of leadership skill areas. *Journal of Agricultural Education*, 46(1), 68-78. doi: 10.5032/jae.2005.01068
- Owen, M. B. (2004). Defining key sub-competencies for administrative county leaders. *Journal of Extension*, 42(2). Retrieved from <https://www.joe.org/joe/2004april/rb3.php>
- Pratt, C. C., McGuigan, W. M., & Katzev, A. R. (2000). Measuring program outcomes: Using retrospective pretest methodology. *American Journal of Evaluation*, 21(3), 341-349.
- Reichheld, F. F. (2003). The one number you need to grow. *Harvard Business Review*, 81(12), 46-55. Retrieved from <http://marketinglowcost.typepad.com/files/the-one-number-you-need-to-grow-1.pdf>
- Rodgers, T.F. (1977). *Competencies critical to the administrative role of the county Extension chairman* (Unpublished doctoral dissertation). North Carolina State University, Raleigh, NC.
- Sanders, C. B. (2014). *Leadership competencies and needs of county Extension directors as perceived by county and district Extension directors and county administrators in Florida* (Unpublished doctoral dissertation). University of Florida, Gainesville, FL.
- Sondgerath, T. (2016). Interdisciplinary professional development needs of cooperative Extension educators. *Journal of Extension*, 54(1). Available at: <https://www.joe.org/joe/2016february/a6.php>
- Whiteside, J. E., & Bachtel, D. C. (1987). Stepping up: Training Extension county extension directors. *Journal of Extension*, 25(1). Retrieved from <https://www.joe.org/joe/1987spring/a4.php>

# **What do they need? Determining Differences in the Classroom-based Professional Development Needs of Louisiana Agriculture Teachers by Years of Teaching Experience**

Whitney Figland, Louisiana State University

Dr. Joey Blackburn, Louisiana State University

Dr. Eric Smith, Louisiana FFA Association

Dr. Kristin Stair, Louisiana State University

## **Abstract**

An ever-changing world of education has led to growing demand for teachers to remain competent and relevant educators. In order for school districts to enhance teacher effectiveness and increase competency, professional development workshops must be tailored to the specific needs of educators. Professional development has been traditionally based on research methodology as a tool to develop these workshops. To further complicate the issue, in-service needs of teachers are ever growing and changing based on experience. The theoretical foundation of this study was Knowles Theory of Andragogy. Per the theory, adult learners are motivated to learn when they feel intrinsic value or realize the personal gain they will receive from the learning activity. The central drive for this study was to determine what Louisiana agriculture teachers desired in terms of classroom based professional development, thereby giving these adult learners a hand in planning professional development activities. The results from this study indicate that there are dissimilar professional development needs based on years of teaching experience. Per the conclusions, the authors recommend that the results of this study be shared with state agricultural education staff, university faculty, the [State] Agriculture Teachers' Association, and anyone else who offers professional development experiences for agriculture teachers. It is also recommended that professional development organizers should consider years of experience when planning professional development seminars.

## **Introduction**

Since the 1980's educational research and policy have focused on ways to reform teacher education. These reform efforts have not just been aimed at teacher preparation programs, but have also focused on providing higher quality in-service opportunities and improving overall teacher quality (Borman & Dowling, 2008). Education is a continually changing field; therefore the needs of teachers are constantly evolving. Teachers often possess varying backgrounds and experiences that make each of their in-services needs uniquely different from one to another. In order to meet these needs, school systems must find ways to meet the growing demand for

teachers to remain relevant and competent (Smith, Lawver, & Foster, 2017). Often, teacher training is conducted through professional development workshops, which are designed to promote and enhance teacher knowledge, provide training in key areas, and increase teaching effectiveness (Borko, 2004). Professional development needs of teachers change over time. There have often been difficulties in identifying which types of training and professional development should be offered (Birkenholz & Harbstreet, 1987; Washburn, King, Garton, & Harbstreet, 2001). Historically, the United States Department of Education has functioned as a base for identifying relevant professional development topics (Gulamhussein, 2013), but research methodology has also been a commonly employed as a tool to determine the topics for professional development (Birkenholz & Harbstreet, 1987; Claycomb & Petty, 1983; Layfield & Dobbins, 2002; Saucier, Tummons, Terry, & Schumacher, 2010; Washburn et al., 2001).

It is not surprising that professional development needs of teachers change over time, especially in career and technical education (CTE). CTE teachers play a vital role in the nations' educational system, so it remains important that these teachers are meeting CTE standards (Cannon, Kitchel, & Duncan, 2012). Specifically, agricultural educators provide students with foundational education in the agricultural industry (Ramsey & Edwards, 2011). In order for these teachers to remain current, it is vital they receive quality professional development. During a typical academic year, 90% of teachers will spend 2 hours per week participating in district-wide professional development seminars (Darling-Hammond, Chung, Andree, Richardson, & Orphanos, 2009). However, these workshops are often short in duration and provide no visible change in student achievement (Yoon, Duncan, Lee, Scarloss, & Shapley, 2007; Bush, 1984).

In agricultural education, a study completed by Garton & Chung (1996) reported four primary areas in need of professional development including (a) motivating students to learn, (b) preparing FFA degree applications, (c) developing a working Program of Activities, and (d) working with proficiency award applications. Similarly, Dobbins and Camp (2000) indicated there was a need for professional development in areas of (a) learning styles, (b) curriculum development, (c) teaching methods, (d) teaching techniques, and (e) technical areas. According to Washburn et al. (2001) professional development needs can vary by geographic location. It has been concluded that states in the same geographic region (i.e., share a common border) can have vastly different in-service needs (Birkenholz & Harbstreet, 1987). This could be due to the fact that most agricultural education programs are state driven, which makes professional development needs vary from state to state. More recent research has also suggested that technical agriculture areas, like agriculture mechanics, are an emerging area in need of professional development (Rasty, Anderson, & Paulsen, 2017; Duncan, Ricketts, Peake & Uessler, 2006). Further, Saucier et al. (2010) identified (a) laboratory teaching practices, (b) global positioning systems, (c) state agricultural tours, (d) biofuels, and (e) biotechnology as the areas of greatest need for Missouri agriculture teachers. This is particularly important because Walker, Garton, & Kitchel (2004) reported agriculture teachers in Missouri who left the profession often “did not enjoy agricultural mechanics laboratory instruction” (p. 35).

Several research studies have indicated the in-service needs of teachers can vary with years of teaching experience (Layfield & Dobbins, 2002; Roberts & Dyers, 2004; Washburn et al., 2001). Many studies have concluded that beginning teachers need professional development in the areas of (a) program planning, (b) lesson planning, and (c) managing student behavior (Shippy, 1981; Mundt 1991; and Talbert, Camp, & Heath-Camp, 1994). It is not surprising that novice teachers lack classroom experiences and may require more intensive professional development to ensure that they are effective teachers. For these teachers especially, their needs will change depending on their educational and personal experiences (Steffy, Wolff, Pasch, & Enz, 2000). Regarding experienced teachers, Layfield and Dobbins (2002) and Washburn et al. (2001) concluded that teachers with 10+ years of teaching experience needed the most professional development in the area of technology integration. It appears the in-service needs of beginning and experienced teachers can be vastly different.

Research has indicated that an adequate preservice preparation program, professional development, and support of teachers are very important in improving teacher quality, competency, and retention (Ruhland & Bremer, 2003). Professional development and continued practice in a content area is something any teacher needs in order to stay relevant. Agriculture teachers, regardless of tenure in the profession, still have a continuing desire for professional development to ensure that their skills remain current (Barrick, Ladewig, & Hedges, 1983).

### **Theoretical and Conceptual Framework**

The theoretical foundation of this study was Knowles (1980) Theory of Andragogy. The Theory of Andragogy is driven by six principles: (a) the learner's need to know, (b) self-concept of the learner, (c) prior experiences of the learner, (d) readiness to learn, (e) orientation to learning, and (f) motivation to learn (Knowles, Holton III, & Swanson, 2015). Per the theory, adult learners are motivated to learn when they feel intrinsic value or realize the personal gain they will receive from the learning activity (Knowles et al., 2015). Further, motivation to learn is enhanced when the adult learners have a hand in planning their learning activities (Knowles, 1980). The central purpose for this study was to determine what Louisiana agriculture teachers desired in terms of classroom based professional development, thereby giving them input in planning professional development activities.

The model of teacher development was the conceptual frame that underpinned this study (Fessler & Christensen, 1992). The model posits that teacher's needs differ based on career stage (see Figure 1). Specifically, Fessler and Christensen (1992) described eight career stages, (a) induction, (b) competency building, (c) enthusiastic and growing, (d) career frustration, (e)

career stability, (f) career wind-down, and (g) career exit. The induction stage is described as the first few years of employment where the new teacher assimilates into the culture of the school and begins to gain confidence in his or her abilities as a professional educator (Fessler & Christensen, 1992; Greiman, 2010). At some point the novice teacher moves into the competency building stage where he or she strives to improve as an educator, this may include seeking out professional development opportunities or enrolling in graduate coursework (Fessler & Christensen, 1992). The enthusiastic and growing stage is marked by a high sense of teacher self-efficacy and career satisfaction. Often these teachers are sought out to share their excitement and expertise (Fessler & Christensen, 1992; Greiman, 2010). Some teachers begin to feel burnt out and unsatisfied in the career frustration stage. This may happen early or late in one's teaching career (Fessler & Christensen, 1992; Greiman, 2010). During the stability stage, the teacher is likely performing adequately but is not actively striving to better their teaching skills. Career wind-down begins as the teacher contemplates leaving the profession and is marked by a period of reflection. Finally, career exit is the period of time after the teacher has left the job (Fessler & Christensen, 1992; Greiman, 2010). It is important to note these stages are not linear and a teacher may move back and forth through each or may never enter all stages. A teachers' career phase is influenced by several factors, broadly classified as organizational or personal in nature (Fessler & Christensen, 1992; Lynn, 2002).

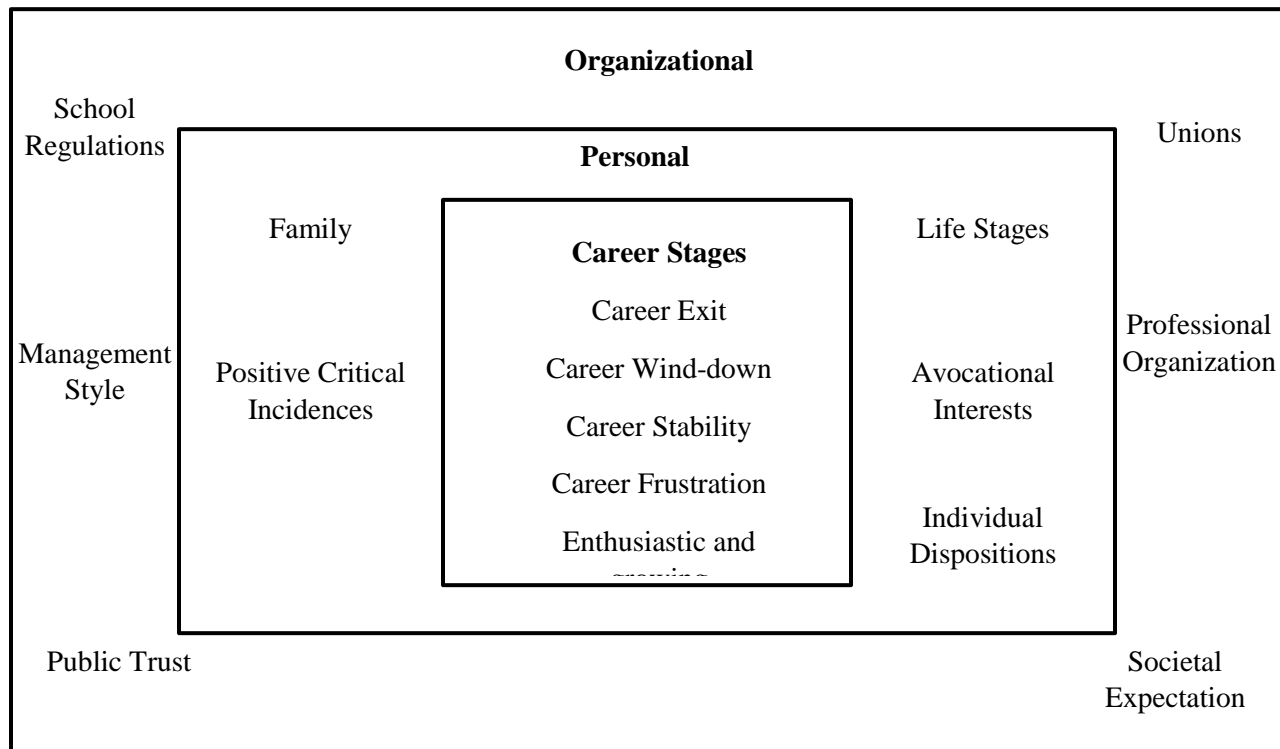

Figure 1. Teacher Career Cycle Model as adapted by Greiman (2010)

A core premise of the model is that teacher development is not a fixed, linear process, but rather ever changing (Fessler & Christensen, 1992; Greiman (2010). As such, teachers within various career stages have different needs for professional development (Fessler & Christensen, 1992; Greiman, 2010). Therefore, individuals involved in organizing teacher professional development should recognize this phenomenon and avoid the one size fits all mentality common in teacher professional development. Agriculture teacher's professional development needs can vary greatly by state (Birkenholz & Harbstriet, 1987; Washburn et al. 2001), as well as by years in the profession (Layfield & Dobbins, 2002; Roberts & Dyer, 2004; Washburn et al., 2001). Therefore, the principle research that arose from the review of literature was: how does the classroom based professional development needs of Louisiana agriculture teachers vary by years of teaching experience?

### **Purpose and Objectives**

The purpose of this study was to identify the classroom-based professional development needs related to agriculture teachers in Louisiana. This research supports the American Association for Agricultural Education's National Research Agenda Research Priority 3: Sufficient Scientific and Professional Workforce that addresses the challenges of the 21st Century (Stripling & Ricketts, 2016). Specifically, this research aims to address Research Priority Question Two, "What methods, models, and practices are effective in recruiting agricultural leadership, education, and communication practitioners (teachers, extension agents, etc.) and supporting their success at all stages of their careers?" (p. 31). The following objectives guided this study:

1. Describe personal and professional characteristics (e.g., years of experience, gender, type of agriculture department) of Louisiana agriculture teachers
2. Identify the instruction and curriculum needs of Louisiana agriculture teachers by years of experience
3. Identify the technical agriculture needs of Louisiana agriculture teachers by years of experience
4. Describe difference in the instruction and curriculum needs of Louisiana agriculture teachers by years of experience
5. Describe differences in the technical agriculture professional development needs of Louisiana agriculture teachers by years of experience

### **Methods**

The target population of this study was all Louisiana agricultural educators actively working during the 2017–2018 academic year ( $N = 261$ ). Data were collected, with a paper instrument delivered by the researcher at each of the three Louisiana FFA Leadership Camp sessions in July 2017. The Louisiana Agriscience Teachers Association meeting is held immediately after lunch at each FFA camp in the conference center near the campground. In all, 190 advisors registered for camp and 164 finished the survey, which yielded 86.0% response rate, representing 62.8% of the total agriculture teacher population in Louisiana. No attempt to collect data from those who did not attend a camp session was attempted because an accurate frame (i.e., directory) of agriculture teachers was not available at the time of data collection.

The instrument employed in this study was utilized by Roberts and Dyer (2004) and modified by Saucier et al. (2010) to investigate the professional development needs of teachers in their respective states. This instrument was further modified by the deletion of items not relevant to [State] and additional items were added to reflect current practice in Louisiana agricultural education. The instrument was comprised of sections that measured teacher needs in the areas of (a) instruction/curriculum, (b) technical agriculture, (c) Career/Leadership Development Events, (d) SAE, (e) program management, and (f) teacher characteristics. For the purposes of this research, only data associated with instruction/curriculum and technical agriculture are reported. Cronbach's alpha was calculated post-hoc to determine internal consistency of the instruction/curriculum ( $\alpha = .91$ ) and the technical agriculture ( $\alpha = .97$ ) sections. Face and content validity were determined by a panel of experts that included two agricultural education faculty members, a doctoral student who had taught agriculture for 14 years in Louisiana, and three current agriculture teachers. After expert review, two items were deleted and several items were reworded to enhance clarity.

Data were analyzed utilizing SPSS version 24 for Macintosh. Descriptive statistics, including mean, standard deviation, frequency, and percentage were utilized to meet the needs for objectives one, two, and three. Objectives four and five sought to describe differences in professional development needs by years of teaching experience, therefore a one-way ANOVA was employed. Further, partial eta squared ( $\eta^2$ ) was calculated to determine practical significance and the Tukey HSD statistic was calculated to determine where differences between groups existed. Due to the exploratory nature of this study, an alpha level of 0.10 was set *a priori*.

## Findings

Objective one sought to determine the personal and professional characteristics of [State] agriculture teachers. The majority ( $f = 110$ ; 65.5%) of these teachers were male and over half ( $n = 86$ ; 51.2%) taught in multiple teacher departments (see Table 1). Most ( $n = 99$ ; 58.9) indicated the bachelor's degree was their highest level of education. Finally, these teachers were categorized by years of teaching experience. Forty-four (26.2 %) had taught 1–5 years, 28 (16.7%) had taught 6–10 years, 29 (17.3%) taught 11–15 years, 21 (12.5%) had taught 16–20 years, 20 (11.9%) had taught 21–25 years, and 21 indicated they had taught 26 or more years.



Table 1

*Personal and Professional Characteristics of Louisiana Agriculture Teachers (n = 168)*

Variable	<i>f</i>	%
Gender		
Male	110	65.5
Female	54	32.1
Type of Agriculture Department		
Single Teacher	77	45.8
Multiple Teacher	86	51.2
Highest Degree Held		
Bachelors Degree	99	58.9
Masters Degree	58	34.5
Doctoral Degree	1	0.6
Other	5	3.0
Years of Experience Categories		
1–5 years	44	26.2
6–10 years	28	16.7
11–15 years	29	17.3
16–20 years	21	12.5
21–25 years	20	11.9
26 or more years	21	12.5

*Note. Percentages may not equal 100 due to missing data*

Table 2 highlights the perceived instructional needs Louisiana agriculture teachers based on years of experience. Teachers with 1 – 5 years of experience reported much need in *Teaching in a Laboratory* ( $M = 2.51$ ) and *Managing Instruction Facilities* ( $M = 2.60$ ). Teachers with 6–10 responded with much need in *Motivating Student Learning* ( $M = 2.57$ ) and *Developing Online Teaching Resources* ( $M = 2.61$ ). Agriculture teachers with 11 – 15 years of experience also responded with much need in *Developing Online Teaching Resources* ( $M = 2.61$ ) and *Using Instructional Technologies* ( $M = 2.46$ ). Teachers with 16+ years of experience all responded with much need in using *Instructional Technologies* and *Developing Online Teaching Resources*. Teachers with 16–20 years of teaching experience perceived little need for professional

development in the areas of (a) *Teaching in a Classroom*, (b) *Teaching in a Laboratory*, (c) *Managing Student Behavior*, and (d) *Teaching Decision-Making Skills*. All other items for all groups were perceived to be areas where at least some need for professional development existed, as interpreted by the real limits of the scale.

The third research objective sought to identify the technical agriculture needs of Louisiana agriculture teachers by years of experience (see Table 3). Overall, Environmental/Natural resources was the highest rated item for teachers who had 1–5 years of experience ( $M = 2.67$ ;  $SD = 1.21$ ), 6–10 years of experience ( $M = 2.57$ ;  $SD = 1.25$ ), 16–20 years of experience ( $M = 2.10$ ;  $SD = 1.00$ ), 21–25 years of experience ( $M = 2.38$ ;  $SD = 1.11$ ), and 26 or more years of experience ( $M = 2.36$ ;  $SD = 0.93$ ). The highest rated item for those who had taught 11–15 years was Animal Science ( $M = 1.97$ ;  $SD = 0.99$ ). All items were perceived to be areas where there was some need for professional development as determined by the real limits of the scale.

Table 2  
*Perceived Instructional Needs of Louisiana Agriculture Teachers*

Instructional Item	Years of Experience											
	1–5		6–10		11–15		16–20		21–25		26 or more	
	<i>M</i>	<i>SD</i>	<i>M</i>	<i>SD</i>	<i>M</i>	<i>SD</i>	<i>M</i>	<i>SD</i>	<i>M</i>	<i>SD</i>	<i>M</i>	<i>SD</i>
Teaching in a Classroom	1.83	1.01	1.68	.98	1.75	1.08	.95	.69	1.70	1.03	1.57	1.21
Teaching an a Laboratory	2.51	1.12	2.07	1.15	2.29	1.05	1.35	1.09	2.00	1.30	1.81	1.17
Using Instructional Technologies	2.07	1.20	2.29	1.15	2.46	.88	1.85	1.09	2.80	.95	2.90	.79
Integrating science into the agriculture curriculum	1.91	1.09	2.04	.96	1.96	.92	1.55	.83	2.05	.95	1.90	.94
Integrating math into the agriculture curriculum	2.05	1.09	1.93	1.05	2.18	.91	1.70	.81	2.35	1.14	2.19	1.12
Managing instructional facilities	2.60	1.13	2.26	1.13	2.00	1.15	1.55	1.00	1.95	1.10	1.86	1.23
Managing student behavior	2.21	1.25	2.07	1.09	1.96	1.00	1.20	1.06	1.65	1.18	2.00	1.38
Motivating student learning	2.16	1.25	2.57	.96	2.39	1.10	1.60	1.05	2.35	1.50	2.29	1.35
Developing online teaching resources	2.47	1.14	2.61	1.16	2.61	1.29	1.90	1.02	2.65	.81	2.81	.93
Teaching decision-making skills	2.14	1.00	2.14	1.01	1.93	1.02	1.40	1.10	2.00	1.30	1.81	1.08
Teaching personal finance	2.14	1.28	2.07	1.01	1.89	1.03	1.80	1.15	1.95	1.15	2.14	1.11
Teaching problem solving skills	2.16	1.23	2.32	1.06	2.32	.98	1.65	1.04	2.35	1.18	2.24	1.18
Instruction Grand Mean	2.19	0.77	2.16	0.72	2.15	0.64	1.54	0.81	2.15	0.81	2.78	0.84

*Note.* Real limits: No Need = 0 – 0.49; Little Need = 0.50 – 1.49; Some Need = 1.50 – 2.49; Much Need = 2.50 – 3.49; Highest Need = 3.50 – 4.00



Table 3

*Perceived Technical Agriculture In-service Needs of Louisiana Agriculture Teachers*

Technical Agriculture Category	<i>Years of Experience</i>											
	<i>1–5</i>		<i>6–10</i>		<i>11–15</i>		<i>16–20</i>		<i>21–25</i>		<i>26 or more</i>	
	<i>M</i>	<i>SD</i>	<i>M</i>	<i>SD</i>	<i>M</i>	<i>SD</i>	<i>M</i>	<i>SD</i>	<i>M</i>	<i>SD</i>	<i>M</i>	<i>SD</i>
Agribusiness	2.32	1.06	2.32	0.84	1.81	0.78	1.73	0.78	2.09	0.96	1.88	0.88
Animal Science	2.36	0.86	2.34	0.95	1.97	0.99	1.56	0.83	2.26	0.71	1.93	0.80
Environmental/Natural Resources	2.67	1.21	2.57	1.25	1.96	1.07	2.10	1.00	2.38	1.11	2.36	0.93
Plant/Soil Science	2.35	1.01	2.32	0.95	1.87	0.85	1.60	0.84	1.94	0.85	1.94	0.87
Agricultural Mechanics	2.22	0.95	2.22	1.02	1.82	0.85	1.73	0.87	2.07	0.93	2.01	0.79
Technical Agriculture Grand Mean	2.38	0.88	2.41	0.77	1.88	0.78	1.74	0.78	2.14	0.71	2.04	0.78

*Note.* Real limits: No Need = 0 – 0.49; Little Need = 0.50 – 1.49; Some Need = 1.50 – 2.49; Much Need = 2.50 – 3.49; Highest Need = 3.50 – 4.00

Objective four sought to determine if differences existed in perceived needs for professional development related to instruction based on years of teaching experience. Prior to calculating a one-way ANOVA, Levene's test for equality of error variances was employed. Specifically, the Levene's test was not statistically significant ( $p = .70$ ), therefore equality of error variances was assumed. The ANOVA yielded  $F(1, 151) = 199.27, p = 0.00, \text{power} = 1.00$  (see Table 5). Partial  $\eta^2$  was calculated to determine practical significance at 0.89, indicating a large effect (Cohen, 1988). The Tukey HSD statistic revealed statistically significant differences between teachers who had taught 16–20 years and the groups of teachers who had taught 1–5 years ( $p = .03$ ), 6–10 years ( $p = .07$ ), 11–15 years ( $p = .08$ ), and 26 or more years ( $p = .10$ ). No differences were found between those who had taught 16–20 years and those who had taught 21–25 years ( $p = .12$ ).

Table 4  
*Analysis of Variance Summary Table for Differences in Instruction Related Professional Development Needs by Years of Experience*

Source	SS	df	MS	F	p	Partial $\eta^2$
Years	690.35	6	115.06	199.27	.00	0.89
Error	87.19	151	.58			
Total	777.54	157				

The goal of objective five was to determine if differences existed in the perceived professional development needs related to technical agriculture based on years of experience. Prior to employing ANOVA, Levene's test was calculated to ensure equality of error variances. Levene's test was determined not to be statistically significant ( $p = .72$ ). The ANOVA yielded  $F(1, 144) = 182.75, p = .00, \text{and power} = .85$ . Partial  $\eta^2$  was calculated at .09 indicating a medium practical effect. The Tukey HSD revealed statistically significant differences between the teachers who had taught 16–20 years and those who had taught 1–5 years ( $p = .04$ ) teachers and 6–10 years ( $p = .06$ ).

Table 5  
*Analysis of Variance Summary Table for Differences in Technical Agriculture Related Professional Development Needs by Years of Experience*

Source	SS	df	MS	F	p	Partial $\eta^2$
Years	700.97	6	116.83	182.75	.00	0.88
Error	92.06	144	0.64			
Total	793.02	150				

### Conclusions/Implications

The purpose of this study was to identify the classroom-based professional development needs of agriculture teachers in Louisiana. The first objective sought to describe the personal and professional characteristics of Louisiana agriculture teachers. A majority of participants were

male and over half taught in a multiple teacher agriculture department. There were more teachers with 1–5 years of experience than any other age group. All teachers reported a professional development need in *Developing Online Teaching Resources*. Agriculture teachers with 1–5 years of experience also indicated *Teaching in a Laboratory* and *Managing Instructional Facilities* as additional areas in which they desired professional development. Teachers with more than six years of experience reported needing professional development in *Using Instructional Technologies*. This aligns with previous research where professional development needs were found in the areas of teaching methods/techniques and technical areas (Dobbs & Camp, 2000). Similarly, Layfield & Dobbins (2002) and Washburn et al. (2001) concluded that teachers with over 10 years of teaching experience needed the most professional development in technology integration.

Objective three examined the perceived technical agriculture in-service needs of Louisiana Agriculture teachers. Teachers with 1–15 years of teaching experience desired professional development in *Animal Science*, and *Environmental/Natural Resources*. Also, teachers with 16+ years of expressed need for professional development related to *Environmental/Natural Resources*, *Agricultural Mechanics*, and *Agribusiness*. Perhaps technical agriculture professional development needs differ because of geographic location. Previous research tells us that professional development needs in states can have vastly different professional development needs based on their region (Birkenholz & Harbstriet, 1987; Washburn et al., 2001). Perhaps professional development needs may vary within regions of a particular state. For example, teachers in the southern region of Louisiana have a particular industry that is important to that region that needs to be emphasized in their curriculum, so they may need professional development in that technical area to provide those skills.

When further exploring objective three, it could be noted that perhaps teachers with 16+ years of experience feel they need more professional development in technical agriculture areas that have re-emerged in agricultural education (i.e., agricultural mechanics). In Louisiana, agriculture teachers are expected to provide Industry Based Certifications (IBCs) as part of their instructional program. One certification program has led to an emphasis in agricultural mechanics coursework and a push for certification in this area by many school administrators. Since this program was implemented in 2006, it is possible that the 16+ year teachers from this study have had to implement this program into their classroom well after they had already established their classroom, which could result in a for need professional development in agricultural mechanics. According to previous research, agricultural mechanics, laboratory teaching practices, GPS, and biotechnology were all areas in need of professional development (Rasty et al., 2017; Saucier et al., 2010).

Objectives four and five sought to determine if differences existed between the perceived professional development needs of teachers related to instruction and technical agriculture based

on years of teaching experience. When exploring objective four, it was concluded that there were statistically significant differences between professional development needs related to instruction for teachers who taught 16 – 20 years, 1 – 5, 6 – 10, 11–15, and 26+ years. Specifically, those teachers who had taught 16 – 20 years felt the least need for professional development in the area of instruction. Perhaps these teachers have reached the career stability stage and believe they are performing their job well and do not desire to change their teaching (Fessler & Christensen, 1992). This finding could serve as additional support for the notion that the teacher career stages are not linear, as teachers with over 21 years of experience felt a stronger need for instructional professional development. Similarly, objective five sought to determine if there were differences in professional development needs related to technical agriculture. It was concluded that there were statistically significant differences between teachers who taught 16–20 years, 1–5, and 6–10 years. Specifically, teachers with 1–5 and 6–10 years of experience felt a greater need for professional development related to technical agriculture. These teachers are likely in the induction or competency building stages and are focused on honing their teaching abilities and furthering their knowledge of agriculture (Fessler & Christensen, 1992).

### **Recommendations**

The results of this study should be shared with state agricultural education staff, university faculty, the Louisiana Agriculture Teachers' Association, and anyone else who offers professional development experiences for agriculture teachers. These groups should work together as a Louisiana Team AgEd to offer relevant professional development experiences based on this research. Per the theory of Andragogy, teachers in Louisiana should be receptive to professional development opportunities based on this research because they had a role in identifying the topics (Knowles, 1980). Further, professional development organizers should consider years of experience when planning workshops. One size fits all professional development workshops may not be the most effective means of encouraging attendance since the results of this study indicate differences based on years of experience. For example, workshops could be offered specifically for 1–5 year teachers in the areas of instructional facility management and laboratory teaching methods. Further, it is recommended that web based professional development (i.e., webinars) be explored as a means to offer training in conducive subject areas. Additionally, professional development opportunities related to technical agriculture areas should be created and targeted toward teachers with 10 or fewer years of experiences.

The National Association of Agricultural Educators (NAAE) has recently implemented a one year professional development training for mid-career teachers (7–15 years). The overall goals of this program are to develop these teachers into mentors for younger teachers, provide mid-career level professional development, and increase longevity and job satisfaction. Perhaps, implementing programs like this for early career teachers (1–6 years) could improve teacher retention, job satisfaction, and teacher effectiveness. Late career teachers (16+ years) could be provided with quality professional development in areas of weakness to improve in overall competency, and perhaps be mentors to early career teachers.



Future research should attempt to gather data from all agriculture teachers in Louisiana. As such, Louisiana agricultural education staff and teacher education departments should attempt to create an accurate, up-to-date frame of agriculture teachers. This would allow data to be collected from those who did not participate in the FFA camp sessions and determine if their professional development needs differ. It is speculated that a number of the teachers who do not attend FFA camp may be alternatively certified and may not know they are expected to attend with FFA members. Further, research should be conducted to determine if professional development needs of Louisiana agriculture teachers differ based on certification type. Alternatively certified teachers have been hired in Louisiana for many years, previous research has indicated that the needs of these teachers differ from those who completed a traditional teacher education program (Roberts & Dyer, 2004; Swafford & Friedel, 2010). Further, the job of being an agriculture teacher extends beyond the classroom and laboratory; therefore research should be completed that identifies professional development needs in the areas of Supervised Agricultural Experience (SAE), FFA advisement, and running a total program.

## References

- Barrick, R.K., Ladewig, H.W., & Hedges, L.E. (1983). Development of a systemic approach to identifying technical inservice needs of teachers. *The Journal of the American Association of Teacher Educators in Agriculture*, 24(1), 13–19. doi: 10.5032/jaatea.1983.01013
- Birkenholz, R. J., & Harbstreit, S. R. (1987). Analysis of the inservice needs of beginning vocational agriculture teachers. *Journal of the American Association of Teacher Educators in Agriculture*, 28(1), 41–49. doi: 10.5032/jaatea.1987.01041
- Borko, H. (2004). Professional development and teacher learning: mapping the terrain. *Educational Researcher*, 33(8), 3–15. doi: 10.3102/0013189X033008003
- Borman, G.D., Dowling, B.N. (2008). Teacher attrition and retention: A meta-analytic and narrative review of the research. *Review of Educational Research*, 78(3), 367–409. doi: 10.3102/0034654308321455
- Bush, R. N. (1984). *Effective staff development in making schools more effective: Proceedings of three state conferences*. San Francisco, CA: Far West Laboratory. Retrieved from <https://eric.ed.gov/?id=ED249576>
- Cannon, J. G., Kitchel, A., & Duncan, D. W. (2012). Perceived teaching and learning professional development needs of Idaho secondary career and technical education teachers. *The Researcher*, 24(1), 43–54. Retrieved from <http://www.nrmera.org/wp-content/uploads/2016/02/Researcherv24n1Cannon.pdf>
- Claycomb, D. M., & Petty, G. C. (1983). A three year longitudinal study of the perceived needs for assistance as ranked by vocational agriculture instructors. *Journal of the American Association of Teacher Educators in Agriculture*, 24(4), 28–33. doi: 10.5032/jaatea.1983.04028
- Darling-Hammond, L., Chung, R.W., Andree, A., Richardson, N., & Orphanos, S. (2009). Professional learning in the learning profession: A status report on teacher development in the U.S. and abroad. *National Staff Development Council*. Retrieved from <http://eric.ed.gov/?id=ED504168>
- Dobbins, T. R., & Camp, W. G. (2000). Clinical experiences for agricultural teacher education programs in North Carolina, South Carolina, and Virginia. *Proceedings of the 27th Annual National Agricultural Education Research Conference*, 543–555. Retrieved from <http://aaaeonline.org/Resources/Documents/National/Proceedings,%20National2000.pdf>
- Duncan, D. W., Ricketts, J. C., Peake, J. B., & Uessler, J. (2006). Teacher Preparation and In-service needs of Georgia Agriculture Teachers. *Journal of Agricultural Education*, 47(2), 24–35. doi: 10.5032/jae.2006.02024

- Fessler, R., & Christensen, J. (1992). Teacher development as a career-long process. In R. Fessler & J. Christensen (Eds.), *The teacher career cycle: Understanding and guiding the professional development of teachers*. Boston, MA: Allyn & Bacon.
- Garton, B. L., & Chung, N. (1996). The inservice needs of beginning teachers of agriculture as perceived by beginning teachers, teacher educators, and state supervisors. *Journal of Agricultural Education*, 37(3), 52–58. doi: 10.5032/jae.1996.03052
- Greiman, B. C. (2010). Continuing professional development. In R. M. Torres, T. Kitchel, & A. Ball (Eds.), *Preparing and advancing teachers in agricultural education*. Columbus, OH: Curriculum Materials Services.
- Gulamhussein, A. (2013). Effective Professional Development in an Era of High Stakes. *Center for Public Education*. Retrieved from <http://www.centerforpubliceducation.org>
- Knowles, M. S. (1980). *The modern practice of adult education: From pedagogy to andragogy*. Chicago, IL: Follet Publishing Company.
- Knowles, M. S., Holton III, E. F., & Swanson, R. A. (2015). *The adult learner: The definitive classic in adult education and human resource development*. New York, NY: Routledge.
- Layfield, K. D., & Dobbins, T. R. (2002). Inservice needs and perceived competencies of South Carolina agricultural educators. *Journal of Agricultural Education*, 43(4), 46–55. doi: 10.5032/jae.2002.04046
- Lynn, S. (2002). The winding path: Understanding the career cycle of teachers. *The Clearing House*, 75(4), 179–182. doi: 10.1080/00098650209604926
- Mundt, J.P. (1991). The induction year - A naturalistic study of beginning secondary teachers agriculture in Idaho. *Journal of Agricultural Education*, 32(1), 18–23. doi: 10.5032/jae.1991.01018
- Ramsey, J. W., & Edwards, M. C. (2011). Entry-level technical skills that agricultural industry experts expected students to learn through their supervised agricultural experiences: A modified Delphi study. *Journal of Agricultural Education*, 52(2), 82–94. doi: 10.5032/jae.2011.02082
- Rasty, J., Anderson, R. G., & Paulsen, T. H. (2017). How the quantity of agricultural mechanics training received at the secondary level impact teacher perceived importance of agricultural mechanics skills. *Journal of Agricultural Education*, 58(1), 36–53. doi: 10.5032/jae.2017.01036
- Roberts, T. G., & Dyer, J. E. (2004). Inservice needs of traditionally and alternatively certified agriculture teachers. *Journal of Agricultural Education*, 45(4), 57–70. doi: 10.5032/jae.2004.04057

- Ruhland, S., & Bremer, C. (2003) Perceptions of traditionally and alternatively certified career and technical education teachers. *Journal of Vocational Education Research*, 28(3), 285–302.
- Saucier, P. R., Tummons, J. D., Terry, R., & Schumacher, L. G. (2010). Professional development inservice needs of Missouri agricultural educators. *Proceedings of the 2010 American Association for Agricultural Education Research Conference, Omaha, NE.*
- Shippy, R.D. (1981). Professional competencies needed by beginning teachers of agriculture/agribusiness. *Journal of the American Association of Teacher Educators in Agriculture*, 22(1), 29–34. doi: 10.5032/jaatea.1981.01029
- Smith, A. R., Lawver, R. G., & Foster, D. D. (2017). *National agricultural education supply and demand study, 2016 Executive Summary*. Retrieved from <http://aaaeonline.org/Resources/Documents/NSD2016Summary.pdf>
- Steffy, B.E., Wolfe, M.P., Pasch, S.H., & Enz, B.J. (2000). *Life cycle of the career teachers*. Thousand Oaks, CA: Corwin Press, Inc.
- Stripling, C. T., & Ricketts, J. C. (2016). Research priority 3: Sufficient scientific and professional workforce that addresses the challenges of the 21st century. In T. Roberts, A. Harder, & M. Brashears (Eds.), *American Association for Agricultural Education National Research Agenda 2016–2020*. (pp. 29–35). Gainesville, FL: Department of Agricultural Education and Communication.
- Swafford, M.R., & Friedel, C.R. (2010). A comparison on the inservice needs of traditionally and alternatively certified beginning agriculture teachers in Louisiana. *Journal of Southern Agricultural Education Research*, 60(1), 90–103. Retrieved from <http://www.jsaer.org/pdf/vol60Whole.pdf>
- Talbert, B.A., Camp, W.G., & Heath-Camp, B. (1994). A year in the lives of three beginning agriculture teachers. *Journal of Agricultural Education*, 35(2), 31–36. doi: 10.5032/jae.1994.02031
- Walker, W. D., Garton, B. L., & Kitchel, T. J. (2004). Job satisfaction and retention of secondary agriculture teachers [Electronic Version]. *Journal of Agricultural Education* 45(2), 28–38. doi: 10.5032.jae.2004.02.028
- Washburn, S. G., King, B. O., Garton, B. L., & Harbstreet, S. R. (2001). A comparison of the professional development needs of Kansas and Missouri teachers of agriculture. In *Proceedings of the 28th National Agricultural Education Research Conference* (Vol. 28, pp. 396–408).

Yoon, K. S., Duncan, T., Lee, S. W. Y., Scarloss, B., & Shapley, K. L. (2007). Reviewing the Evidence on How Teacher Professional Development Affects Student Achievement. Issues & Answers. REL 2007-No. 033. *Regional Educational Laboratory Southwest (NJ1)*.

## **Describing the Differences in the Professional Development needs of Traditionally and Alternatively Certified Agriculture Teachers in Louisiana**

Dr. Kristin Stair, Louisiana State University  
Whitney Figland, Louisiana State University  
Dr. Joey Blackburn, Louisiana State University  
Dr. Eric Smith, Executive Director, Louisiana FFA Association

### **Abstract**

*For decades, teacher education programs have suffered from teacher shortages in many content areas. Due to high teacher turnover rate there has been an increase in the amount of teachers who are entering the field through alternative certification programs. It has been noted that the professional development needs of traditionally and alternatively certified teachers may differ drastically. The purpose of this study was to identify the professional development needs of agriculture teachers in Louisiana based on certification type. Data were collected at each of the three Louisiana FFA Leadership Camp sessions during the Louisiana Agriculture Teacher's Association meeting held on the first day of camp. In all, 190 agriculture teachers registered for camp and 164 completed the instrument, representing an 86.0% response rate of camp attendees and 62.8% of the total agriculture teacher population. The results from this study indicated that professional development related to Program Management was the only statistically significant difference between the two groups. Specifically, the traditionally certified teachers felt a greater need for professional development in this area. Based on this research, there may be less difference in the professional development needs of teachers based on certification type in Louisiana than expected based on previous research.*

### **Introduction**

Teacher shortages have been an ongoing and long-standing problem in public education (Boe, Cook, & Sutherland, 2008). High turnover rates have often been cited as a contributor to low student performance (Ingersoll, 2002; Kersaint, Lewis, Potter, & Meisels, 2005) and increased educational costs (National Commission on Teaching and America's Future, 2003; Borman & Dowling, 2008). High teacher turnover rates require schools to continuously hire new teachers who are often young, inexperienced, and more likely to leave the profession (Ingersoll, 2004; Rockoff, 2004). This ongoing crisis has required many school systems to adjust their hiring standards related to teacher licensure in an effort to fill vacant positions (Ingersoll & Smith, 2003; National Commission on Teaching America's Future, 1997).

In the United States teacher turnover has been a long standing issue. In fact, between the 1999-2000 and 2000-2001 academic years there was a 16% rate of turnover (National Center for Educational Statistics [NCES], 2005). Over half of the turnover was attributed to teachers leaving the profession (NCES, 2005). That attrition rate is almost twice as high as in other top-performing nations like Singapore and Finland (Sutcher, Darling-Hammond, & Carver-Thomas,

2016). This number is even higher for teachers in school districts with high poverty, with approximately 21% of teachers leaving those schools each year (Donaldson & Johnson, 2011). Agricultural education has also suffered from a lack of qualified teachers. In fact, Kantrovich (2007) reported shortages of agriculture teachers as far back as 1965. Unfortunately, this trend is still occurring. Smith, Lawver, and Foster (2016) reported a shortfall of agriculture teachers existed as of September 2016. Further, research has indicated that over 40% of agriculture teachers leave the profession by their sixth year (Walker, 2002).

Further compounding the issue is the fact that between 2009 and 2014 enrollment in teacher preparation programs decreased by almost 35% (Kearney, 2017; Berry & Shields, 2017). This decrease could be attributed to shifts in the profession caused by decreased pay, increased rigor in teacher education program standards, and a decrease in the perceived quality of working conditions of teachers (Guarino, Santibanez, & Daley, 2006). Another factor that may contribute to teacher attrition is the absence of meaningful training and support of teachers. This lack of support may be a factor in a teacher's decision to leave the profession (Marinell & Coca, 2013).

Traditionally, most teachers are trained through a teacher preparation program housed within a college or university. However, with schools struggling to fill positions, teachers who enter the profession through alternative certification routes are becoming more common. Since the development of the No Child Left Behind Act in 2001, states have been encouraged to pursue educational programs that provide alternative paths to licensure (Bell, Cihak, & Judge, 2010). These alternative paths differ greatly across programs and across states, but they all generally provide access to educational careers outside of the traditional university preparation process (Hawley, 1992). These programs are often designed to allow teachers to begin teaching immediately on a temporary license while pursuing additional training to meet their states standards (Kersaint, Lewis, Potter, & Meisels, 2007). Ruhland and Bremer (2003) found that alternative routes to certification include a wide variety of experiences including testing of occupational competency, professional experience, or the successful completion of a baccalaureate degree in a specified content area.

While the development of alternative certification programs has helped to ensure that there are teachers in the classrooms, it is unclear if hiring these individuals is a viable solution to the problem of teacher shortages and teacher retention. Alternatively certified teachers experience unique challenges when they enter the classroom. These challenges have often led to a much lower retention rate than their traditionally certified counterparts (Robinson & Edwards, 2012). Alternatively certified teachers may begin teaching with less experience and may require higher levels of support in order to be successful (Ruhland & Bremer, 2003). Traditionally certified teachers are often considered to be well rounded in almost every dimension of teaching, including curriculum and instruction development, classroom management, awareness of learning styles, and overall knowledge of students (Darling-Hammond, Chung, & Frelow, 2002).

There are, however, several benefits of alternative certification. First, these alternative programs often provide a path to teaching for individuals who may have a high level of content knowledge, but are unable to enter the classroom through a traditional college programs (Kearns, 1990). These individuals may be older and more committed to teaching as a second career choice after a

career in industry, or have other jobs or experiences that traditional teachers may not have (Darling-Hammond & Hudson, 1990). Teachers coming from a non-traditional background may also be more diverse than those who come from a traditional teacher preparation background. This can be especially important for urban programs that have a more diverse study population (Kane, Rockoff, & Staiger, 2007). In terms of effectiveness, several studies have indicated there may not be a significant difference between alternatively certified teachers and their traditional counterparts (Rockoff, 2004; Kane, et al., 2007) or in some cases, that teachers who come from alternative programs may be even more effective than traditional teachers (Decker, Mayer, & Glazerman, 2004).

In agricultural education, Rocca and Washburn (2006) identified a primary distinction between traditional and alternatively certified teachers as the number of years of experience alternatively licensed teachers may have upon entering the teaching field in a specific sector of the agriculture industry. However, experience is not the only difference between certification types. Graham and Garton (2003) suggested that certification type actually had little impact on teaching performance. However, other studies have described traditionally certified teachers as being more successful overall and having higher ratings than those teachers who entered the profession through an alternative certification route (Darling-Hammond et al., 2002). Knobloch and Whittington (2002) found that new agricultural education teachers who completed traditional teacher preparation programs, which included a student teaching experience, were more confident than alternatively certified teachers that had never completed a traditional teacher preparation program. Alternatively certified teachers in agricultural education have been identified as being less effective in fostering student achievement (Robinson & Edwards, 2012) and less efficacious in technical knowledge (Duncan & Ricketts, 2008). Other studies have indicated that one of the greatest differences between traditionally and alternatively certified teachers is the lack of pedagogical skills provided to alternatively licensed teachers during training (Wayman, Foster, & Mantle-Bromley, 2003).

Teaching professionals have diverse backgrounds and experiences that establish the need for continuous professional development. In agricultural education, ongoing professional development seminars over many different agricultural and educational topics are needed for teachers to stay relevant. Research comparing the professional development needs of traditionally and alternatively certified agriculture teachers has indicated that alternatively certified teachers have in-service needs that differ from their traditionally certified counterparts (Roberts & Dyer, 2004; Swafford & Friedel, 2010). Alternatively licensed agriculture teachers often experience greater needs in areas related to instruction, curriculum, program planning, and technical agriculture (Roberts & Dyer, 2004; Swafford & Friedel, 2010). Several studies have also found that agriculture teachers desire training in FFA proficiencies and degree applications (Garton & Chung, 1996; Layfield & Dobbins, 2002; Joerger, 2002; Peiter, Terry, & Cartmell, 2003; Duncan, Ricketts, Peake, & Uessler, 2006). The third part of the total program model, Supervised Agricultural Experiences (SAEs), are often considered difficult for teachers to put into practice, even those from traditional teacher preparation programs, (Barrick & Estep, 2011). This may be even more of a challenge for alternatively certified teachers.



The conceptual framework of this study is based on the economic principal of supply and demand within labor markets (Ehrenberg & Smith, 1997). This framework has been employed in educational research to better describe the factors that contribute to the demand of available teaching positions being unable to be filled with the current supply of teachers (Boardman, Darling-Hammond, & Mullin, 1982; Haggstrom, Darling-Hammond, & Grissmer, 1988; Guarino, Santibanez, & Daley, 2006). As described by Guarino, Santibanez, and Daley (2006), teacher shortages occur in the educational system when teaching is no longer the most attractive activity for teachers. This measure of attractiveness can be made up of a variety of factors, but is primarily made up of ease of entry, compensation, and personal satisfaction (Guarino, Santibanez, & Daley, 2006).

In order to adequately balance supply and demand, teaching has to be seen as an attractive option. This can be addressed at multiple levels, but includes both entry into the profession (e.g., recruitment) and keeping individuals in the profession (e.g., retention). Professional development training is one method of addressing teacher needs in an effort to retain those teachers within their current educational field.

Historically, agriculture teachers have had a continuing desire for professional development to ensure that their skills are current and up to date (Barrick, Ladewig, & Hedges, 1983). Teachers' professional development needs are further complicated because they will change over time (Roberts & Dyers, 2004; Birkenholz & Harbstriet, 1987; Layfield & Dobbins, 2002; Washburn, King, Garton, & Harbstriet, 2001). In Louisiana very little research has been conducted on the unique needs of alternatively certified teachers versus those of traditionally certified teachers. In an effort to focus on the supply of teachers in agricultural education in Louisiana, the principle question that arose from the review of literature was: how do the professional development needs of traditionally and alternatively certified teachers differ?

### **Purpose and Objectives**

The purpose of the study was to identify the professional development needs of agriculture teachers in Louisiana based on certification type. This research supports the American Association for Agricultural Education's National Research Agenda Research Priority 3: Sufficient Scientific and Professional Workforce that addresses the challenges of the 21st Century (Stripling & Ricketts, 2016). Specifically, this research helps to address Research Priority Question Two, "What methods, models, and practices are effective in recruiting agricultural leadership, education, and communication practitioners (teachers, extension agents, etc.) and supporting their success at all stages of their careers?" (p. 31). The following objectives guided this study:

1. Describe personal and professional characteristics (e.g., years of experience, gender, certification type) of Louisiana agriculture teacher
2. Identify the instruction and curriculum professional development needs of Louisiana agriculture teachers by type of certification

3. Identify the technical agriculture professional development needs of Louisiana agriculture teachers type of certification
4. Identify the FFA (e.g., CDE, LDE, and Program Management) and SAE professional development needs of Louisiana agriculture teachers by type of certification
5. Describe differences in the instruction and curriculum professional development needs of Louisiana agriculture teachers by type of certification
6. Describe differences in technical agriculture professional development needs of Louisiana agriculture teachers by type of certification
7. Describe differences in FFA (e.g., CDE, LDE, and Program Management) and SAE professional development needs by certification

### **Methodology**

The target population of this study was all Louisiana agriculture teachers employed during the 2017–2018 academic year ( $N = 261$ ). Data were collected at each of the three Louisiana FFA Leadership Camp sessions during the Louisiana Agriculture Teacher’s Association meeting held on the first day of camp. Per Louisiana Department of Education policy, all agriculture teachers in Louisiana are required to attend the camp with FFA members. In all, 190 agriculture teachers registered for camp and 164 completed the instrument, representing an 86.0% response rate of camp attendees and 62.8% of the total agriculture teacher population. No attempt was made to collect responses from those who did not attend camp because an accurate and current directory was not available at that time to contact non-attendees. As such, results from this study should not be generalized past those who responded.

For the purposes of this study, traditional certification was defined as teacher licensure obtained along with a bachelor’s degree from an accredited post-secondary institution. As defined by the Louisiana Department of Education, alternative certification is licensure through any other means. Common paths to alternative certification in Louisiana are graduate programs offered at post-secondary institutions, post-baccalaureate certification only programs at post-secondary institutions, and private teacher certification entities. No attempt to discern paths to alternative certification was made in this research.

A modified version of an instrument developed by Roberts and Dyer (2004) was utilized to collect data for this study. Items irrelevant to Louisiana were deleted and additional items were added to reflect current practice in agricultural education. The instrument was comprised of sections that measured needs in the areas of (a) instruction/curriculum, (b) technical agriculture, (c) Career/Leadership Development Events, (d) SAE, (e) program management, and (f) teacher demographics. Cronbach’s alpha was calculated post-hoc to determine internal consistency of the instruction/curriculum ( $\alpha = .91$ ), technical agriculture ( $\alpha = .97$ ), CDE ( $\alpha = .93$ ), LDE ( $\alpha = .88$ ), Program Management ( $\alpha = .94$ ), and SAE ( $\alpha = .90$ ) sections. Face and content validity were determined by a panel of experts including two agricultural education faculty members, a doctoral student who had taught for 14 years in Louisiana, and three current agriculture teachers. After expert review, two items were deleted and several items were reworded to provide clarity.

## Findings

Objective one sought to describe the personal and professional characteristics of [State] agriculture teachers. In all, years of teaching agriculture ranged from one to 38 years, with 13.67 being the average number of years taught (see Table 1). The average teaching experience for traditionally certified teachers was 15.50 ( $SD = 10.21$ ) years. The mean number of years alternatively certified teachers had taught was 10.14 years ( $SD = 9.43$ ).

Table 1

*Louisiana Agriculture Teachers Years of Teaching Experience (n = 168)*

Years of Teaching Experience	Minimum	Maximum	M	SD
Traditionally Certified	1	38	15.50	10.21
Alternatively Certified	1	26	10.14	6.55
Overall	1	38	13.67	9.43

Table 2 describes the personal and professional characteristics of Louisiana agriculture teachers. Overall, 64.3% of agriculture teachers were traditionally certified, and 33.3% were alternatively certified. Regarding gender, there were 109 male teachers and 54 female teachers. Of the traditionally certified teachers, 70 (64.8%) were male and 37 (34.3%) were female. There were 39 (69.6%) alternatively certified male teachers and 17 (30.4%) alternatively certified female teachers.

Table 2

*Personal and Professional Characteristics of Louisiana Agriculture Teachers (n = 168)*

Variable	f	%
Certification type		
Traditional	108	64.3
Alternative	56	33.3
No Response	4	2.4
Gender		
Male – Traditionally Certified	70	64.8
Female – Traditionally Certified	37	34.3
Male – Alternatively Certified	39	69.6
Female – Alternatively Certified	17	30.4

*Note.* Percentages may not equal 100 due to missing data.

Objective two sought to identify the instruction related professional development needs of Louisiana agriculture teachers by type of certification (see Table 3). Overall, both groups of teachers perceived all items as being areas of some need for professional development.

*Developing Online Teaching Resources* was the highest rated item for both the traditionally ( $M = 2.56$ ;  $SD = 1.07$ ) and alternatively certified ( $M = 2.38$ ;  $SD = 1.21$ ) teachers. Similarly, the *Using*

*Instructional Technologies* was the next highest rated item for both the traditionally ( $M = 2.36$ ;  $SD = 1.09$ ) and alternatively certified ( $M = 2.29$ ;  $SD = 1.13$ ) teachers. Traditionally certified teachers felt the lowest need for *Teaching in a Classroom* ( $M = 1.59$ ;  $SD = 1.02$ ). Similarly, the alternatively certified teachers felt the least need for professional development for *Teaching in a Classroom* ( $M = 1.65$ ;  $SD = 1.08$ ) and *Integrating Science into the agriculture curriculum* ( $M = 1.65$ ;  $SD = 0.99$ ).

Table 3

*Perceived Instruction Related Professional Development Needs of Louisiana Agriculture Teachers by Type of Certification*

Instructional Item	Certification Type			
	Traditional		Alternative	
	M	SD	M	SD
Teaching in a Classroom	1.59	1.02	1.65	1.08
Teaching an a Laboratory	2.16	1.18	1.93	1.18
Using Instructional Technologies	2.36	1.09	2.29	1.13
Integrating science into the agriculture curriculum	2.03	0.95	1.65	0.99
Integrating math into the agriculture curriculum	2.14	1.05	1.87	1.00
Managing instructional facilities	2.15	1.18	2.04	1.17
Managing student behavior	1.93	1.25	1.84	1.09
Motivating student learning	2.31	1.26	2.07	1.14
Developing online teaching resources	2.56	1.07	2.38	1.21
Teaching decision-making skills	1.95	1.11	1.89	1.03
Teaching personal finance	2.05	1.10	1.91	1.21
Teaching problem solving skills	2.24	1.08	2.02	1.24
Instruction Grand Mean	2.13	0.78	1.96	0.79

*Note.* Real limits: No Need = 0 – 0.49; Little Need = 0.50 – 1.49; Some Need = 1.50 – 2.49; Much Need = 2.50 – 3.49; Highest Need = 3.50 – 4.00

Objective three was to identify the perceived technical agriculture related in-service needs of Louisiana agriculture teachers (see Table 4). Overall, both groups of teachers felt at least some need for professional development for each technical agriculture area. Traditionally certified teachers reported the greatest need for professional development in *Environmental/National Resources* ( $M = 2.43$ ;  $SD = 1.14$ ) and *Animal Science* ( $M = 2.16$ ;  $SD = 0.92$ ). Alternately certified teachers reported the greatest need in *Environmental/Natural Resources* ( $M = 2.23$ ;  $SD = 1.16$ ) and *Agribusiness* ( $M = 2.04$ ;  $SD = 1.01$ ). Traditionally certified teachers perceived the least need for professional development in *Agribusiness* ( $M = 2.05$ ;  $SD = 0.90$ ) and the alternatively certified rated *Agricultural Mechanics* ( $M = 1.91$ ;  $SD = 0.96$ ) as the area they least needed professional development.

Table 4

*Perceived Technical Agriculture Related Professional Development Needs of Louisiana Agriculture Teachers by Type of Certification*

Instructional Item	Certification Type			
	Traditional		Alternative	
	<i>M</i>	<i>SD</i>	<i>M</i>	<i>SD</i>
Agribusiness	2.05	0.90	2.04	1.01
Animal Science	2.16	0.92	2.01	0.90
Environmental/Natural Resources	2.43	1.14	2.23	1.16
Plant/Soil Science	2.07	0.94	1.99	0.97
Agricultural Mechanics	2.09	0.91	1.91	0.96
Technical Agriculture Grand Mean	2.19	0.80	2.02	0.89

*Note.* Real limits: No Need = 0 – 0.49; Little Need = 0.50 – 1.49; Some Need = 1.50 – 2.49; Much Need = 2.50 – 3.49; Highest Need = 3.50 – 4.00

Objective 4 sought to identify the FFA (e.g., CDE, LDE, and Program Management) and SAE professional development needs of Louisiana agriculture teachers by certification type (see Table 5). Overall, both groups perceived at least some need for each category. Traditionally certified teacher perceived the most need for professional development related to program management ( $M = 2.40$ ;  $SD = 0.95$ ) and the least amount of need in SAE ( $M = 1.99$ ;  $SD = 0.86$ ). CDEs ( $M = 2.19$ ;  $SD = 0.95$ ) and LDEs ( $M = 2.19$ ;  $SD = 0.99$ ) were the highest rated items by alternatively certified teachers, while SAE ( $M = 1.81$ ;  $SD = 0.90$ ) was the lowest rated item by this group of teachers.

Table 5

*Perceived FFA and SAE Related Professional Development Needs of Louisiana Agriculture Teachers by Type of Certification*

Item	Certification Type			
	Traditional		Alternative	
	<i>M</i>	<i>SD</i>	<i>M</i>	<i>SD</i>
Career Development Events	2.17	0.89	2.19	0.95
Leadership Development Events	2.20	0.97	2.19	0.99
Program Management	2.40	0.95	2.02	1.01
Supervised Agricultural Experience	1.99	0.86	1.81	0.90

*Note.* Real limits: No Need = 0 – 0.49; Little Need = 0.50 – 1.49; Some Need = 1.50 – 2.49; Much Need = 2.50 – 3.49; Highest Need = 3.50 – 4.00

Objective 5 sought to determine the differences in instruction related to professional development needs by certification type (see Table 6). Overall, there was no statistically

significant difference between traditionally ( $M = 2.13$ ) and alternatively ( $M = 1.96$ ) certified teachers in relation to instruction related professional development needs,  $t(157) = 1.27, p = .21$ .

Table 6  
*Independent Samples t-test Differences in Instruction Related Professional Development Needs by Type of Certification*

Group	<i>M</i>	<i>SD</i>	<i>df</i>	<i>t</i>	<i>p</i>
Traditional Certification	2.13	.78	157	1.27	.21
Alternative Certification	1.96	.79			

Objective six sought to determine the differences in technical agriculture related professional development needs by certification type (see Table 7). Overall, there was no statistically significant difference between alternatively ( $M = 2.02$ ) and traditionally ( $M = 2.19$ ) certified teachers when determining the differences between technical agriculture professional development,  $t(150) = 1.13, p = .26$ .

Table 7  
*Independent Samples t-test Differences in Technical Agriculture Related Professional Development Needs by Type of Certification*

Group	<i>M</i>	<i>SD</i>	<i>df</i>	<i>t</i>	<i>p</i>
Traditional Certification	2.19	.80	150	1.13	.26
Alternative Certification	2.02	.89			

The goal of objective seven was to determine if differences existed in the FFA (e.g., CDE, LDE, and Program Management) and SAE professional development needs of [State] agriculture teachers by certification type (see Table 8). There were no statistically significant differences in the perceived professional development needs of traditionally and alternatively certified teachers in the areas of CDEs, LDEs, and SAE. A statistically significant differences was detected in the area of Program Management,  $t(154) = 2.35, p = .02$ .

Table 8  
*Independent Samples t-test Differences in FFA and SAE Related Professional Development Needs by Type of Certification*

Group	<i>M</i>	<i>SD</i>	<i>df</i>	<i>t</i>	<i>p</i>
Career Development Events					
Traditional Certification	2.17	0.89	155	-0.12	0.91
Alternative Certification	2.19	0.95			
Leadership Development Events					
Traditional Certification	2.20	0.97	157	0.07	0.94
Alternative Certification	2.19	0.99			
Program Management					
Traditional Certification	2.40	0.96	154	2.35	0.02

Alternative Certification	2.02	1.01			
SAE					
Traditional Certification	1.99	0.86	161	1.26	0.21
Alternative Certification	1.81	0.89			

### Conclusions, Discussion and Recommendations

The purpose of this study was to identify the professional development needs of agriculture teachers in Louisiana based on certification type. Teachers come from very diverse backgrounds and these differences can impact the needs of teachers regarding professional development. In an effort to help decrease teacher attrition, and increase the supply of teachers in the field, a better understanding of the needs of both traditionally certified teachers and lateral entry teachers is critically important.

When exploring objective one, a majority of agriculture teachers in Louisiana had taught for about 14 years. Overall, a majority of the teachers were traditionally certified and male. However, over one-third of teachers in Louisiana identified themselves as being alternatively certified. This number is similar to the 2011 national teaching demographics, which identified 65% of teachers in the U.S come from a traditional undergraduate certification program (Feistritzer, 2011). This is a large proportion of teachers and an important segment to consider when developing materials, professional development opportunities, and resources. Because alternative certification programs differ greatly, teachers may have very different backgrounds in what components of the total program in which they have received training.

Objective two sought to identify the instruction and curriculum needs of Louisiana agriculture teachers by type of certification. Overall, both traditionally and alternatively, certified teachers reported the highest need for professional development in *Using Instructional Technologies*, and *Developing Online Teaching resources*. Alternatively certified teachers also reported *Motivating Student Learning* and *Managing Instructional Facilities* as having some need for professional development. Further, traditionally certified teachers reported *Teaching Problem Solving Skills*, *Motivating Student Learning*, and *Teaching in a Laboratory* as areas for some need for professional development. This is similar to previous research in agricultural education in which teachers identified needing professional development in curriculum development, teaching methods/techniques, learning styles, and motivating students to learn. These trends are common for both traditionally and alternatively certified teachers (Dobbs & Camp, 2000; Garton & Chung, 1996). However, Roberts and Dyers (2004) and Swafford and Friedel (2010) indicated that alternatively certified teachers had greater needs in instruction/curriculum, program planning, and technical agriculture than their traditionally certified counterparts. Both groups of teachers expressed a desire to learn more about managing facilities effectively. Based on this research, there are several common areas in which both traditional and alternatively certified teachers could be provided with professional development.

Objective three highlighted the perceived technical agriculture related in-service needs of Louisiana agriculture teachers. Traditionally certified teachers reported some need in *Environmental/Natural Resources* and *Animal Science*. However, alternatively certified teachers

reported some need in *Agribusiness* and *Environmental/Natural Resources*. Further exploration of objective three showed all of the technical agriculture categories were rated in need of some professional development by both traditional and alternatively certified teachers. This is contrary to previous research conducted by Rocca and Washburn (2006), which indicated that alternatively certified teachers might have more content expertise than traditionally certified teachers. It is somewhat surprising that teachers in this study expressed a need for training in all content areas, this may be a result however of little technical agriculture professional development being conducted in recent years for agriculture teachers at the state level in Louisiana. According to Barrick, et al. (1983), teachers in agriculture often express a desire for new content knowledge so that they can be up to date in content knowledge across various content areas.

Objective four sought to identify the FFA (e.g., CDE, LDE, and Program Management) and SAE professional development needs of Louisiana agriculture teachers by certification type. Traditionally certified teachers reported the most need for professional development in program management. Alternatively certified teachers reported CDE's and LDE's as their highest need for professional development. However, SAE was the lowest rated item by both groups of teachers. Overall, both traditionally and alternatively certified teachers reported some need for professional development in each category. However, previous research found that professional development in FFA proficiency awards and degree award application is often desired by all teachers, regardless of their entry into the profession (Garton & Chung, 1996; Layfield & Dobbins, 2001; Joerger, 2002; Peiter, et al., 2003; Duncan et al., 2006). It is not surprising that alternatively certified teachers may express a greater desire for CDE and LDE training, as they have likely received less of this training. SAE's continue to be an area that many teachers indicate a need for training. Previous research has shown has shown SAE's to be a part of the total agricultural program that is often least understood and the most difficult to develop by teachers (Barrick & Estepp, 2011).

Independent samples t-tests were calculated for objectives five and six to determine if differences existed between the professional development needs related to instruction and those related to technical agriculture between alternatively certified teachers and traditionally certified teachers. No statistically significant differences existed between either groups of teachers in these areas. This is contrary to previous studies which indicate that alternatively certified teachers have significantly difference content needs when compared to traditionally certified teachers (Roberts & Dyer, 2004; Swafford & Friedel, 2010). However, these results do more closely mirror other areas of educational research, which have found that alternatively certified teachers are similar in both needs and abilities as traditionally prepared teachers (Rockoff, 2004; Kane, Rockoff, & Staiger, 2007).

Finally, independent samples t-tests were employed to describe the differences in FFA and SAE professional development needs by certification type. Overall, there were no statistically significant differences in the perceived professional development needs of traditionally and alternatively certified teachers in CDE's, LDE's, and SAE. However, there was a statistically significant difference in Program Management, specifically the traditionally certified teachers



felt greater need for professional development than the alternatively certified teachers. It has been understood that alternative licensure programs vary greatly. Some teachers in Louisiana may have had an FFA background themselves and therefore been more prepared to provide a total program. There is also the possibility that several of these alternatively certified teachers may have been mentored as part of their licensing process by more experienced agriculture teachers that were able to help assist them in FFA and SAE program components. It could also be that more of the alternatively certified teachers who were not previously given more information about FFA and SAE were not aware that attending camp was a requirement and therefore were excluded from this population.

Across various studies on alternative licensure versus traditional licensure, the specific route of licensure is not always known. Alternative certification programs vary greatly in the amount of pre-service preparation provided (Feistritz & Haar 2008; Darling-Hammond, 2000). This makes it particularly difficult to determine which teachers may have a thorough understanding of the total agricultural program. Therefore, it is recommended for future research that full census of agriculture teachers in [State] be taken and determine which programs alternatively licensed teachers are becoming certified through and what pre-service experiences these programs provide. It is also recommended that research be conducted regularly to identify trends in teacher needs over time.

As this research relates to recommendations for practice, few significant differences were identified between teachers who were traditionally certified versus those who were alternatively certified. This may indicate that structured professional development for alternatively certified teachers does not need to be a priority area. Instead, other areas may be more critical to teacher success across the state. After future research, there may be trends related to other areas such as support for early career teachers depending on their level of experience, or professional development related to teacher backgrounds and experience with FFA and SAE programs.

## References

- Barnett, B. & Shields, P. (2017). Solving the teacher shortage. *Phi Delta Kappan*, 98 (2), 8–18. doi: 10.1177/0031721717708289
- Boe, E., Cook, L., & Sutherland (2008). Teacher turnover: Examining exit attrition, teaching area transfer, and school migration. *Exceptional Children*, 75(1), 7–31. doi: 10.1177/001440290807500101
- Barrick, R. K., & Estep, C. M. (2011). Experience programs in agriscience education: From projects to SAEPs and beyond. *The Agricultural Education Magazine*, 83(4), 26–27. Retrieved from [www.naae.org/profdevelopment/magazine/](http://www.naae.org/profdevelopment/magazine/)
- Barrick, R. K., Ladewig, H. W., & Hedges, L. E. (1983). Development of a systemic approach to identifying technical inservice needs of teachers. *The Journal of the American Association of Teacher Educators in Agriculture*. 24(1), 13–19. doi: 10.5032/jaatea.1983.01013
- Bell, S. M., Cihak, D. F., & Judge, S. (2010). A Preliminary Study: Do Alternative Certification Route Programs Develop the Necessary Skills and Knowledge in Assistive Technology? *International Journal of Special Education*, 25(3), 110–118. Retrieved from <http://eric.ed.gov/?id=EJ909041>
- Birkenholz, R. J., & Harbstreet, S. R. (1987). Analysis of the inservice needs of beginning vocational agriculture teachers. *Journal of the American Association of Teacher Educators in Agriculture*, 28(1), 41–49. doi: 10.5032/jaatea.1987.01041
- Boardman, A. E., Darling-Hammond, L., & Mullin, S. P. (1982). A framework for the analysis of teachers' demand and supply. *Economics of Education Review*, 2(2), 127–155. doi: 10.1016/0272-7757(82)90038-3
- Borman, G. D., & Dowling, N. M. (2008). Teacher attrition and retention: A meta-analytic and narrative review of the research. *Review of educational research*, 78(3), 367–409. doi: 10.3102/003465408321455
- Darling-Hammond, L. (2000). Teacher quality and student achievement. *Education policy analysis archives*, 8(1). doi: 10.14507/epaa.v8n1.2000
- Darling-Hammond, L., Chung, R., & Frelow, F. (2002). Variation in teacher preparation: How well do different pathways prepare teachers to teach? *Journal of Teacher Education*, 53(4), 286–303. doi: 10.1177/0022487102053004002
- Darling-Hammond, L., & Hudson, L. (1990). Chapter 4: Precollege Science and Mathematics Teachers: Supply, Demand, and Quality. *Review of research in education*, 16(1), 223–264. doi: 10.3102/0091732X016001003

- Decker, P. T., Mayer, D. P., & Glazerman, S. (2004). The effects of Teach for America on students: Findings from a national evaluation. *University of Wisconsin--Madison, Institute for Research on Poverty*. Retrieved from <http://www.ssc.wisc.edu/irpweb/publications/dps/pdfs/dp128504.pdf>
- Dobbins, T. R., & Camp, W. G. (2000). Clinical experiences for agricultural teacher education programs in North Carolina, South Carolina, and Virginia. *Proceedings of the 27th Annual National Agricultural Education Research Conference*. 543–555.
- Donaldson, M. L., & Johnson, S. M. (2011). Teach For America teachers: How long do they teach? Why do they leave? *Phi Delta Kappan*, 93(2), 47–51. doi: 10.1177/003172171109300211
- Duncan, D. W., Ricketts, J. C., Peake, J. B., & Uessler, J. (2006). Teacher preparation and in-service needs of Georgia agriculture teachers. *Journal of Agricultural Education*, 47(2), 24–35. doi: 10.5032/jae.2006.02024
- Ehrenberg, R., & Smith, R. (1997). *Modern labor economics: Theory and public policy* (6th ed.). Reading, MA: Addison-Wesley.
- Feistritzer, C. E. (2011). Profile of teachers in the United States. *National Center for Education Information*.
- Feistritzer, C. E., & Haar, C. K. (2008). *Alternate routes to teaching*. Prentice Hall.
- Garton, B. L., & Chung, N. (1996). The inservice needs of beginning teachers of agriculture as perceived by beginning teachers, teacher educators, and state supervisors. *Journal of Agricultural Education*, 37(3), 52–58. doi: 10.5032/jae.1996.03052
- Graham, J., & Garton, B. (2003). Certification measures: are they predictive of secondary agriculture teacher performance? *Journal of Agricultural Education*, 44(3), 54–65. doi: 10.5032/jae.2003.03054
- Guarino, C. M., Santibanez, L., & Daley, G. A. (2006). Teacher recruitment and retention: A review of the recent empirical literature. *Review of educational research*, 76(2), 173–208. doi: 10.3102/00346543076002173
- Haggstrom, G.W., Darling-Hammond, L., & Grissmer, D.W. (1988). *Assessing teacher supply and demand*. Santa Monica, CA: The RAND Corp.
- Hawley, W. D. (1992). *The Alternative Certification of Teachers*. *Teacher Education Monograph No. 14*. ERIC Clearinghouse on Teacher Education, One Dupont Circle, NW, Suite 610, Washington, DC 20036-1186.

- Ingersoll, R. M. (2002). The teacher shortage: A case of wrong diagnosis and wrong prescription. *NASSP bulletin*, 86(631), 16–31. doi: 10.1177/019263650208663103
- Ingersoll, R. M. (2004). *Why do high-poverty schools have difficulty staffing their classrooms with qualified teachers?* Center for American Progress, Institute for America's Future.
- Ingersoll, R., & Smith, T. (2003). The wrong solution to the teacher shortage. *Educational Leadership*, 60(8), 30-33. Retrieved from <http://ascd.org/publications/educationalleadership/>
- Joerger, R. M. (2002). A comparison of the inservice education needs of two cohorts of beginning Minnesota agricultural education teachers. *Journal of Agricultural Education*, 43(3), 11–24. 10.5032/jae.2002.03011
- Kane, T. J., Rockoff, J. E., & Staiger, D. O. (2007). Teacher Certification. *Education Next*, 7(2), 6–9. Retrieved from [http://educationnext.org/files/ednext\\_20072\\_06.pdf](http://educationnext.org/files/ednext_20072_06.pdf)
- Kantrovich, A. J. (2007). *A national study of the supply and demand for teachers of agricultural education from 2004-2006*. Morehead, KY: Morehead State University.
- Kearney, P. J. (2017, July 16). Where are all the teachers going? *HuffPost*. Retrieved from [https://www.huffingtonpost.com/entry/where-are-all-of-the-teachers-going\\_us\\_596b7e10e4b06a2c8edb474c](https://www.huffingtonpost.com/entry/where-are-all-of-the-teachers-going_us_596b7e10e4b06a2c8edb474c)
- Kearns, D. (1990, February 28). Do teachers really need licenses? *Wall Street Journal*, p. 14.
- Kersaint, G., Lewis, J., Potter, R., & Meisels, G. (2007). Why teachers leave: Factors that influence retention and resignation. *Teaching and Teacher Education*, 23(6), 775–794. doi: 10.1016/j.tate.2005.12.004
- Knobloch, N., & Whittington, M. S. (2002). Novice teachers' perceptions of support, teacher preparation quality, and student teaching experience related to teacher efficacy. *Journal of Vocational Education Research*, 27(3), 331-341. Retrieved from <http://scholar.lib.vt.edu/ejournals/JVER>
- Layfield, K. D., & Dobbins, T. R. (2002). Inservice needs and perceived competencies of South Carolina agricultural educators. *Journal of Agricultural Education*, 43(4), 46–55. doi: 10.5032/jae.2002.04046
- Marinell, W. H., & Coca, V. M. (2013). "Who stays and who leaves?" Findings from a three-part study of teacher turnover in NYC middle schools. *Online Submission*. Retrieved from <http://eric.ed.gov/?id=ED540818>

- National Center for Educational Statistics (2005). The condition of education 2005. *Education Statistics Quarterly*, 7(1/2). Retrieved from [https://nces.ed.gov/programs/quarterly/vol\\_7/1\\_2/9\\_1.asp](https://nces.ed.gov/programs/quarterly/vol_7/1_2/9_1.asp)
- National Commission on Teaching and America's Future. (1997). *Doing what matters most: Investing in quality teaching*. New York: Author.
- Peiter, R. L., Terry J., R., & Cartmell, D. D. (2003). Identification of mentors for first year agricultural education teachers. In *Proceedings of the 30th National Agricultural Education Research Conference CD ROM* (pp. 175–189).
- Roberts, T. G., & Dyer, J. E. (2004). Inservice needs of traditionally and alternatively certified agriculture teachers. *Journal of Agricultural Education*, 45(4), 57–70. doi: 10.5032/jae.2004.04057
- Robinson, J., Edwards, C. M. (2012). Assessing the teacher self-efficacy of agriculture instructors and their early career employment status: A comparison of certification types. *Journal of Agricultural Education*, 53(1), 150–161. doi: 10.5032/jae.2012.01150
- Rocca, S., & Washburn, S. (2006). Comparison of teacher efficacy among traditionally and alternatively certified agriculture teachers. *Journal of Agricultural Education*, 47(3), 58–69. doi: 10.5032/jae.2006.03058
- Rockoff, J. E. (2004). The impact of individual teachers on student achievement: Evidence from panel data. *The American Economic Review*, 94(2), 247–252. doi: 10.1257/0002828041302244
- Ruhland, S., & Bremer, C. (2003). Perceptions of traditionally and alternatively certified career and technical education teachers. *Journal of Vocational Education Research*, 28(3), 285–302. doi: 10.5328/JVER28.3.285
- Smith, A. R., Lawver, R. G., & Foster, D. D. (2017). *National agricultural education supply and demand study, 2016 Executive Summary*. Retrieved from <http://aaaeonline.org/Resources/Documents/NSD2016Summary.pdf>
- Stripling, C. T., & Ricketts, J. C. (2016). Research priority 3: Sufficient scientific and professional workforce that addresses the challenges of the 21st century. In T. Roberts, A. Harder, & M. Brashears (Eds.), *American Association for Agricultural Education National Research Agenda 2016–2020*. (pp. 29–35). Gainesville, FL: Department of Agricultural Education and Communication.
- Sutcher, L., Darling-Hammond, L., & Carver-Thomas, D. (2016). A coming crisis in teaching. *Teacher supply, demand, and shortages in the US*. Retrieved from <http://learningpolicyinstitute.org>

- Swafford, M. R., & Friedel, C. R. (2010). A comparison on the inservice needs of traditionally and alternatively certified beginning agriculture teachers in Louisiana. *Journal of Southern Agricultural Education Research*, 60(1), 90–103. Retrieved from <http://www.jsaer.org/pdf/vol60Whole.pdf>
- Truell, A. D. (1999). Concerns of traditionally and alternatively certified marketing education teachers. *Delta Pi Epsilon Journal*, 41(2), 89-104. Retrieved from <https://search.proquest.com>
- Wash, S. L., Lovedahl, G. G., & Paige, W. D. (2000). A comparison of traditionally and alternatively certified technology education teachers' professional development and receptivity to change. *E-Journal of Industrial Teacher Education*, 37(2). Retrieved from <http://scholar.lib.vt.edu/ejournals/JITE>
- Walker, W. D. (2002). *Retention and attrition of Missouri agriculture teachers*. Unpublished doctoral dissertation, University of Missouri, Columbia.
- Washburn, S. G., King, B. O., Garton, B. L., & Harbstreit, S. R. (2001). A comparison of the professional development needs of Kansas and Missouri teachers of agriculture. In *Proceedings of the 28th National Agricultural Education Research Conference* (Vol. 28, pp. 396–408).
- Wayman, J. C., Foster, A. M., Mantle-Bromley, C., & Wilson, C. A. (2003). A comparison of the professional concerns of traditionally prepared and alternatively licensed new teachers. *The University of North Carolina Press*, 86(3), 35–40. doi: 10.1353/hsj.2003.0005

## **Determining Content Knowledge Needs for Professional Development of In-service Agricultural Education Teachers in South Carolina**

Catherine A. DiBenedetto, Clemson University  
Victoria C. Willis, Clemson University  
K. Dale Layfield, Clemson University

### **Abstract**

*The purpose of this study was to administer a needs assessment to determine areas of discrepancy based on perceived levels of proficiency and importance of concepts related to content knowledge of in-service agricultural education teachers in South Carolina. The population frame for the study included all secondary agriculture teachers in South Carolina. Demographic data that included personal and program profiles were collected. The Educational Testing Service's (ETS) Praxis Study Companion: Agriculture (5701) Exam was used to provide an in-depth understanding of teacher's needs. The Borich needs assessment model was used to discern between teachers' perceived knowledge of Praxis' content areas and their perceived level of importance of each content item. The constructs of each pathway were analyzed and ranked using mean weighted discrepancy scores (MWDS), providing data for the final rankings, categorized using grand mean weighted discrepancy scores (GMWDS). Findings included that most of the GMWDS data for teachers were in the low range, indicating a low perceived need based on the concepts in the study. A notable area of need for future in-service was found in the Agribusiness Systems pathway.*

### **Introduction**

Studies dating as far back as the 1960s emphasize the importance of agriculture teacher in-service for content training and specialized areas (Cline, 1963). From Cline's study to the present, researchers sought a current understanding of agriculture teachers needs for pre-service and in-service activities. Throughout this time, the topics studied often included a set of educational and agricultural content competencies developed from previous research (Birkenholz & Harbstreit, 1987; Claycomb & Petty, 1983; Duncan, Ricketts, Peake, & Uessler, 2006; Golden, Parr & Peake, 2014; Hillison, 1977; Joerger, 2002; Kahler, 1974; Layfield & Dobbins, 2002; Shippy, 1981; Valli, 1992; Veeman, 1984). Up to this point, studies provided a substantial understanding of the general needs in the various agriculture and natural resource content areas and topics related to FFA and SAE. For many years, a lack of nationally adopted standards for school-based agricultural education (SBAE) resulted in a void of studies that pinpoint teachers' needs regarding the capacity to teach all instructional standards.

In 2003, the United States Department of Education (USDE) Clusters Project led the introduction of the Agriculture, Forestry and Natural Resources (AFNR) Career Cluster Content Standards (Honeycutt, 2015). These standards provided a baseline at the national level to support further development of curriculum at state and local levels. In 2009, the National Council for Agricultural Education (The Council) appointed the National AFNR Career Cluster Content Standards Committee to develop the National AFNR Career Cluster Content Standards for the agricultural education profession. The Council representation included leaders in agricultural education and the National FFA. The National FFA provided the financial support for the

development of the standards as part of the project, “National FFA 10 x 15.” The project’s objective was “to provide state agricultural education leaders and teachers with a forward-thinking guide for what students should know and be able to do through the study of agriculture in grades 9 through 14” (The National Council for Agricultural Education, 2015).

The impetus for the 2009 development of the AFNR Career Cluster Content Standards came from the Carl Perkins Act of 2006 (hereafter referred to as Perkins IV). In section 2 of Perkins IV, leaders in states and localities are encouraged to develop challenging academic and technical standards to provide students with preparation for high skill occupations “in current or emerging professions” (Carl D. Perkins Career and Technical Education Improvement Act of 2006, § 2).

In 2011, ETS initiated a revision of the Praxis II Agriculture Exam (5701), in conjunction with a National Advisory Committee consisting of secondary agricultural educators, teacher educators and others. This decision of the Advisory Committee aligns with the recommendation made by Thobega and Miller (2008), “In the future, if PRAXIS II tests are required of pre-service teachers, teacher educators in agriculture must provide leadership in selecting or developing an appropriate content area licensure examination” (Thobega & Miller, 2008, p. 107). Praxis exams are used by many states to support the licensure/certification process (Flippo, 2002). Mr. K. Cureton (personal communication, October 2, 2017) described the process used to develop the revised Agriculture Praxis. Cureton explained that knowledge and skill statements based on standards by The Council and various state standards were sent by survey to several thousand educators across the country for feedback.

Revision of the PRAXIS II Agriculture Content Exam introduces a paradigm for how more concise needs assessments in agricultural education could be implemented. The Praxis II is a product of an exhaustive synthesis of contributions from agricultural educators, teacher educators and other stakeholders through National AFNR Career Cluster Content Standards. This led to knowledge and skill statements that developed the Praxis, which Mr. K. Cureton (personal communication, October 2, 2017) shared, is currently used by 24 states. Considering nearly half of the states in the U.S. use the Praxis II for certification, this provides a tool for assessing the technical content needs of school-based agricultural educators.

## **Review of Literature**

Research focused on determining the in-service needs of agricultural educators has been prevalent in the literature base over the past thirty years. Barrick, Ladewig, and Hedges (1983) developed a survey instrument that outlined specific technical agriculture topics to determine needs by identifying importance of, relative knowledge of, and relative ability of agricultural educators. The research of Claycomb and Petty (1983) was based on the notion that as teachers developed in their careers, their needs changed and evolved. Needs of agricultural educators should be determined by specific career stages and will vary dependent upon those stages. Similarly, a variety of needs are indicated by novice teachers (Birkenholz & Harbstreit, 1987).

The last known recorded research study published on in-service needs of South Carolina agricultural educators was a study from 2002 titled, “*In-service Needs and Perceived Competencies of South Carolina Agriculture Educators*” (Layfield & Dobbins, 2002). The study compared the needs of beginning and experienced agriculture teachers in South Carolina. Layfield and Dobbins, (2002) recommended more research be conducted on in-service needs of agriculture teachers on a national level to uncover common needs among varying states. “At the



national level, findings from this and similar studies in agricultural education needs assessments should be considered by the National Agricultural Education Research Workgroup” (Layfield & Dobbins, 2002, p.54). Nationwide needs assessment research results have the potential to greatly improve the future of agricultural education and increase the efficiency and effectiveness of in-service workshops offered for agricultural education teachers. “As the number of states with timely and relevant needs assessment data increases, researchers should analyze data to identify national trends in agricultural education” (Duncan, Ricketts, Peake, & Uessler, 2006, p. 33).

Previous research has demonstrated that distinctions exist among in-service needs of agricultural education teachers and the types of assessment instruments that have been utilized to determine how to best design high-quality professional development to best serve their challenges. The ETS Praxis Study Companion: Agriculture (5701) Exam covers topics which agricultural educators should possess competence in and has the ability to serve as the content which researchers can collect and analyze data to determine needs. Following the recommendation of previous research, this study created a needs assessment instrument in which the competencies assessed were derived from the ETS Praxis Study Companion: Agriculture (5701) Exam, which has been regarded as a fair and valid source to assess subject-specific academic competency and determine teacher licensure (ETS PRAXIS, 2015).

### **Theoretical Framework**

Social cognitive theory served as the theoretical framework that guided this research. Social cognitive theory suggests “people act on their judgments of what they can do, as well as on their beliefs about the likely effects of various actions” (Bandura, 1986, p. 231). Personal, behavioral, and environmental factors arise through a bidirectional series of events influencing one’s sense of self-efficacy (Bandura, 1986). By having teacher’s self-report their perceived importance and competency levels of various subjects and topics, they are providing their own perception of their self-efficacy towards their beliefs of proficiency and importance of the content knowledge they possess. Self-efficacy has been defined as one’s perceived belief of their aptitude to learn or perform behaviors (Schunk, 2012). Teacher effectiveness has been aligned with social cognitive theory and research has indicated professional development provides occasions for teacher enrichment (Estep, Stripling, Conner, Giorgi & Roberts, 2013). ). As teachers have opportunities to reflect upon and improve their teaching effectiveness through professional development, self-efficacy can be built.

### **Purpose and Objectives**

To assist with the design of future high quality professional development, the purpose of this research was to administer a needs assessment to determine areas of discrepancy based on perceived levels of proficiency and importance of concepts related to content knowledge of in-service agricultural education teachers in South Carolina. To achieve our purpose the following objectives were addressed:

1. Describe the demographic profile of in-service agricultural education teachers and the characteristics of their SBAE programs in South Carolina;
2. Utilize the topics in the ETS Praxis Study Companion: Agriculture (5701) Exam to assess South Carolina in-service agricultural education teachers’ perceived need for professional development using Mean Weighted Discrepancy Scores (MWDS) in the following seven

content areas I. Agribusiness Systems, II. Animal Systems, III. Food Science and Biotechnology Systems, IV. Environmental and Natural Resource Systems, V. Plant Systems, VI. Power, Structural, and Technical Systems, VII. Leadership and Career Development;

3. Using Grand Mean Weighted Discrepancy Scores (GMWDS), rank priority areas of need for professional development within a pathway using the ETS Praxis Study Companion: Agriculture (5701) Exam for South Carolina in-service agricultural education teachers' reported discrepancy between perceived importance and competency levels.

### **Methods and Procedures**

A non-experimental, descriptive survey design was used for this research. The study received approval by the Clemson University Institutional Review Board and was determined exempt. The overall population for the study consisted of a census of agricultural education teachers in South Carolina. South Carolina agricultural education teachers were sent a link to the survey, powered through Qualtrics®. State Staff collaborated with the researchers to assist with data collection by sending emails containing the survey link to all agricultural educators in their specified region. A friendly regional competition among the State Staff served as an incentive for each regional coordinator to obtain responses from the teachers in their regions. Data was collected throughout the month of April 2017. Survey respondents were offered an incentive of a chance to win instructional supplies, valued at \$100, for completing the survey by the established deadline. The survey was administered to 132 agricultural education teachers with a 69% response rate.

The ETS Praxis Study Companion: Agriculture (5701) Exam was used to develop an instrument using the Borich model (1980) for assessing need. The ETS Praxis Study Companion: Agriculture (5701) Exam is broken up into seven pathways. Those pathways are broken into constructs, which are then broken into variables within a construct. ETS was contacted and provided with details regarding the intended use of the Study Companion. Once permission was granted from ETS to use content from the Praxis Study Companion: Agriculture (5701) Exam, an instrument was designed in Qualtrics® to administer the survey to a census of in-service agricultural education teachers in South Carolina. Each of the seven content areas (Agribusiness Systems, Animal Systems, Food Science and Biotechnology Systems, Environmental and Natural Resource Systems, Plant Systems, Power, Structural, and Technical Systems, and Leadership and Career Development) were outlined using the representative descriptions of topics in each category covered on the ETS Praxis Study Companion: Agriculture (5701) Exam. The Food Science and Biotechnology Systems construct was omitted from the data analysis because only one teacher in South Carolina reported teaching the pathway. The ETS Praxis Study Companion: Agriculture (5701) Exam was deemed appropriate for data collection because the “test content is appropriate for examinees who have completed a bachelor’s degree program in agricultural education” (ETS PRAXIS, 2015).

The Borich Model (1980) was used for the instrument design to rank concepts and determine priority area of need. The Borich Model (1980) uses a discrepancy between two measures of an item and allows respondents to provide their perceptions of competency related to the given topic and their relative belief about the importance of the topic as it relates to teaching in the agricultural education curricula. The MWDS was calculated to establish rankings based on priority area of need (Borich, 1980). The following calculation was used to determine

MWDS: (Discrepancy= importance level - ability level for each topic),  $MWDS = [(Importance\ Rating - Ability\ Rating) \times (M\ Importance\ Rating)] / \text{Number of Observations}$ .

All survey respondents participated in the Agribusiness Systems and Leadership and Career Development pathway sections of the instrument as these concepts are not taught in isolated courses in South Carolina, but typically integrated into each course within a pathway. For all other pathways, respondents were asked if they taught the pathway or not before entering each section of the instrument. For all variables within a construct, respondents were asked to rank their perceived importance and competency level. The importance and competency level scale used a Likert scale ranging from one to five, with one indicating low importance/low competence, and five indicating high importance/high competence. The instrument also contained sections related to demographic profiles, education level, curriculum, and SBAE program structure. A reliability coefficient of  $\alpha = .84$  was reported for the Praxis II: Agriculture (5701) Exam (K. Cureton, personal communication, October 2, 2017). Considering the Praxis II Agriculture (5701) Exam is a reflection of the study companion, we deemed an expert panel for review was not required when using the concepts outlined in the ETS Praxis Study Companion: Agriculture (5701) Exam to develop the instrument for data collection.

The MWDS was calculated for each variable within a construct, which included the teacher's perceived importance and competency level data, using Microsoft Excel. The GMWDS was then calculated from the MWDS summary table data by taking each variable's MWDS and calculating the average, using Microsoft Excel. Variables were categorized into their appropriate construct category, according to ETS Praxis Study Companion: Agriculture (5701) Exam. MWDS and GMWDS were analyzed to maximize the efficiency and applicability for teacher professional development sessions. Findings from this study can only be generalized to the population of interest, South Carolina agricultural education teachers, but with a 69% response rate may provide insight and a starting point for other states to consider and conduct similar data collection by replication of this research.

## Findings

The first objective of the study was to describe the demographic profile and program characteristics of South Carolina agriculture teachers. Teachers taught 1-3 years (19.35%), followed by 7-10 years (18.28%). The most dominant age group of the respondents was 26-30 year olds (18.89%), followed by 31-35 year olds (16.67%). Male respondents (52.17%) outnumbered female respondents (47.83%). The most common race reported by respondents was white (94.68%), followed by black or African American (4.26%), and other (1.06%).

The most common academic degree held by respondents was a master's degree (60.8%), followed by a bachelor's degree (36.96%). An open response question was asked to determine where the teachers obtained their degrees; the majority attended Clemson University (81%). A majority of the teachers were certified through traditional certification (92.39%), followed by alternative certification (7.61%). When asked if teachers would be interested in pursuing an online master's degree program at Clemson University, a majority of respondents said definitely not (38.89%), followed by probably not (16.67%). Respondents preferred to attend in-service trainings in the summer (56%), followed by district/regional meetings (25%), fall semester (10%), spring semester (7%), and other (1%). An open response question provided the opportunity for teachers to express feedback with regard to specific areas that might help researchers understand their current needs as an agriculture teacher. Responses ( $n = 17$ ) were

primarily centered on animal science. Additionally, developing a Young Farmer program, use of an advisory board, budgeting/updating equipment, and managing a greenhouse were reported.

In regard to program characteristics, the predominant primary pathway taught by the respondents was Horticulture (40.86%), followed by Plant and Animal Systems (27.96%), Environmental and Natural Resource Systems Management (23.66%), Agricultural Mechanics and Technology (6.45%), and Biosystems Engineering Technology (1.08%). When asked which secondary pathway teachers taught, the predominant answer was they taught only one pathway (38.20%), followed by Environmental and Natural Resource Systems Management (24.72%). When asked which instructional resources teachers utilized in daily planning and teaching, MyCAERT® was the predominant response (51.8%), followed by the other category (29.5%). When asked how many teachers were in their agricultural education program, the majority answered one (63.44%), followed by two (27.96%). Most teachers taught at a high school agricultural education program (93.55%), followed by middle school agricultural education program (3.23%) and both middle school and high school agricultural education program.

Objective two required computing the MWDS for each variable within the construct for each pathway. The MWDS data was summarized in the conclusions to assist with providing clarity between the variables (specific content topics/learning objectives) in each of the pathway constructs. Objective three required computing the GMWDS to rank the constructs. The GMWDS was calculated using Excel for the variables that occurred within each pathway’s constructs. The GMWDS scores were ranked from highest to lowest, with a larger GMWDS indicating greater priority need for in-service, and a smaller GMWDS implying less of a need for in-service. The GMWDS findings for each of the systems pathway constructs are displayed in table format below for ease of readability.

The **Agribusiness Systems** construct (n=91 responses) results in order from highest need to lowest need are presented in Table 1. All respondents were asked to complete this section of the instrument. Agribusiness accounting systems and marketing principles were the highest area of priority need constructs reported in the Agribusiness Systems pathway.

Table 1: Ranking of Agribusiness Systems Pathway

<b>Constructs within Agribusiness Systems</b>	<b>GMWDS</b>
D. “Is familiar with generally accepted accounting practices for making agribusiness decisions.”	2.13
F. “Is familiar with the marketing principles needed to accomplish agribusiness objectives.”	2.03
C. “Know the record keeping needed to accomplish agribusiness objectives.”	1.77
A. “Know the principles of capitalism and entrepreneurship in the agribusiness industry.”	1.76
B. “Know the management skills needed to organize an agribusiness.”	1.76
E. “Is familiar with the fundamentals of savings, investments, and credit in agribusiness.”	1.66

*Note.* Letter codes next to each construct within a pathway were derived from the ETS Praxis Study Companion: Agriculture (5701) Exam.

The **Animal Systems** construct (n = 37 responses) results are presented in order from highest need to lowest need in Table 2. In South Carolina one pathway consists of both animal and plant systems. Respondents were asked to rank the percentage of the curriculum they taught which focused on Plant Systems (50.43%) versus Animal Systems (49.57%). Only those currently teaching the Plant and Animal pathway responded to this section. Overall, teachers in South Carolina feel confident to teach the concepts in the Animal Systems pathway.

Table 2: Ranking of Animal Systems Pathway

<b>Constructs within Animal Systems</b>	<b>GMWDS</b>
C. "Is familiar with proper health care of animals."	1.28
G. "Is familiar with normal and abnormal animal behavior."	.910
F. "Know safety practices related to animal production."	.687
E. "Know the basic principles of animal production and management."	.530
D. "Know basic principles of animal nutrition."	.505
L. "Is familiar with the issues related to animal rights, animal welfare, and producer responsibilities."	.475
A. "Is familiar with the historical development and trends of the animal systems industry."	.355
I. "Know the principles and practices of basic animal reproduction."	.332
H. "Is familiar with the proper design and use of animal facilities and the equipment for safe and efficient production."	.280
J. "Is familiar with the effects of environmental conditions on animal production."	.235
K. "Is familiar with the impacts of animal production on the environment."	.170
B. "Know the classification, anatomical, and physiological characteristics of animals."	.165

The **Environmental and Natural Resource Systems (ENR)** construct (n = 38 responses) results in order from highest need to lowest need are presented in Table 3. Only those currently teaching the Environmental and Natural Resource Systems pathway responded to this section of the instrument. Overall, teachers in South Carolina felt confident to teach the concepts in the Environmental and Natural Resource Systems pathway.

Table 3: Ranking of ENR Pathway

<b>Constructs within ENR</b>	<b>GMWDS</b>
A. "Is familiar with natural cycles related to environmental and natural resource management."	1.32
F. "Know the use of personal protective equipment (PPE) and safety procedures related to environmental and natural resource management."	1.31
K. "Is familiar with procedures used to develop an environmental and natural resource management plan."	1.15
L. "Know the general impact of land use on environmental and natural resources."	1.15

I.	“Is familiar with wetlands and their role in the environment.”	.930
G.	“Is familiar with the role of environmental and natural resource management in the local, state, and national economies.”	.883
E.	“Is familiar with current issues and regulations in environmental and natural resource management.”	.875
H.	“Is familiar with the impact of conventional and alternative energy resources on the environment.”	.660
J.	“Is familiar with the use, production, and processing of natural resources.”	.650
D.	“Is familiar with the ecological concepts and principles related to natural resource systems.”	.582
B.	“Is familiar with chemical properties related to environmental and natural resources.”	.510
C.	“Know the various ecosystems of the environment.”	.220

The **Plant Systems** construct (n = 38 participants) results in order from highest need to lowest need are presented in Table 4. Only those currently teaching the Plant and Animal pathway responded to this section of the instrument. Overall, teachers in South Carolina indicated little need for professional development in concepts in the Plant Systems pathway.

Table 4: Ranking of Plant Systems Pathway

<b>Constructs within Plant Systems</b>		<b>GMWDS</b>
J.	“Is familiar with the principles and elements of landscape and floral design.”	1.00
B.	“Know general safety issues related to plant systems.”	.718
F.	“Know the basic characteristics of both soils and growing media and their uses.”	.612
H.	“Is familiar with production and management practices associated with horticultural crops.”	.507
E.	“Is familiar with propagation, cultivation, and harvesting of plants.”	.460
I.	“Is familiar with production and management practices associated with agronomic crops.”	.298
D.	“Is familiar with the influence of environmental factors on plant growth.”	.005
C.	“Know the basic principles of identification, classification, anatomy, and physiology as related to plant production and management.”	-0.022
A.	“Know the historical development of plant science and its relationship with society.”	-0.027
G.	“Is familiar with the use of integrated pest management (IPM) in plant production.”	-0.15

The **Power, Structure, and Technical Systems** construct (n = 7 participants) results are presented in order from highest need to lowest need in Table 5. Only those currently teaching the Power, Structure and Technical Systems pathway responded to this section of the instrument.

Agricultural education teachers in South Carolina indicated a high priority need for professional development in the application of technology in the agriculture industry.

Table 5: Ranking of Power, Structure, and Technical Systems Pathway

<b>Constructs within Power, Structure, and Technical Systems</b>	<b>GMWDS</b>
K. “Is familiar with the application of technology to the agriculture industry.”	3.18
D. “Is familiar with the principles of power, energy transfer, and conversion.”	1.60
A. “Is familiar with the physical science principles and engineering applications associated with power, structural, and technical systems.”	.633
F. “Know the safe operation and maintenance of hand tools, power tools, and other equipment.”	.590
H. “Is familiar with the planning and building of structures.”	.444
L. “Is familiar with the use of technical and mathematical approaches to map land, facilities, and infrastructure.”	.420
I. “Is familiar with metal fabrication and welding.”	.403
C. “Is familiar with various power and energy sources.”	.243
B. “Is familiar with electricity and electrical wiring.”	.117
E. “Know the proper use, storage, and disposal of potentially hazardous materials common to the agricultural mechanics laboratory.”	.012
G. “Is familiar with the principles of small-engine operation, maintenance, and repair.”	-.09
J. “Is familiar with the installation, maintenance, and repair of water systems.”	-.392

The **Leadership and Career Development** construct (n = 91) results are presented in order from highest need to lowest need in Table 6. All respondents were asked to complete the leadership and career development section of the instrument. Overall, teachers in South Carolina indicated little need for professional development in Leadership and Career Development.

Table 6: Ranking of Leadership and Career Development Pathway

<b>Constructs within Leadership and Career Development</b>	<b>GMWDS</b>
B. “Know the foundational areas of career development.”	1.35
E. “Know communication skills.”	1.06
A. “Know the principles of leadership.”	.885
G. “Understand supervised agricultural experiences (SAE).”	.812
F. “Know information research skills to make informed decisions.”	.775
D. “Know individual and team leadership skills.”	.725
H. “Know career opportunities across the various pathways of agriculture.”	.153
I. “Is familiar with local program planning and management.”	-.15
C. “Understand the purpose, structure, and function of the National FFA Organization.”	-.43

## Conclusions, Implications, and Recommendations

The majority of agricultural educators in South Carolina are within their first ten years of teaching. Teachers within the early to mid-stage of their careers may require additional in-service opportunities until they become established, which indicates that professional development opportunities may need to be offered specifically geared toward various career stages.

Overall results indicated low to negative GMWDS, which indicated that teachers are well informed and knowledgeable on the constructs and variables within the AFNR pathways that they are currently responsible to teach. It should be noted that teachers responded to the pathway questions only if they taught that particular pathway, excluding Agribusiness Systems and Leadership and Career Development, as all teachers responded in those pathways. We believe focusing on pathways currently taught by the teachers provided more reliable data to utilize for planning future professional development programs and reviewing curricula within our state.

It is encouraging to see our current agricultural educators self-reporting few areas in which they perceive a crucial need; this reinforces that South Carolina agricultural education teachers are competent and have the perceived skills necessary to teach students on the reported construct areas outlined in the ETS Praxis Study Companion: Agriculture (5701) Exam. Given 81% of the respondents attended Clemson University the findings imply that the program of study at Clemson University has provided students with the knowledge and technical skills required to teach agriculture. We acknowledge that teacher's responses are based on their perceived abilities and perceived importance of the construct variables and thus the study is strongly rooted in self-efficacy and the social cognitive theory. By becoming more aware of teacher's perceived abilities and importance levels, we can better address areas where teachers perceive lower abilities to customize professional development to teacher's specific needs.

To clarify the difference in the purpose of objectives two and three, we utilized each specific area of content need as outlined by the ETS Praxis Study Companion: Agriculture (5701) Exam. Objective two focused on the MWDS to assess perceived need for professional development, according to specific variables (curricular objectives) within the pathway, while objective three focused on using the GMWDS to determine teachers' perceived importance and competency levels, according to each construct or topic area in the overall pathway. To provide a more in depth look at the conclusions made with regard to perceived needs by curricular objectives we separately analyzed the MWDS in each pathway.

Within the **Agribusiness Systems** pathway, the top three highest MWDS scores for Agribusiness Systems variables included "Describe commodity futures and options trading" (2.55), followed by "Distinguish between hedging and speculation" (2.43), and "Develop a balance sheet and analyze its issues" (2.37). The top three MWDS data revealed a high need for variables within construct F, "Is familiar with the marketing principles needed to accomplish agribusiness objectives." High need variables within construct F, when analyzing the top three variables, included "Describe commodity futures and options trading" (2.55) and "Distinguish between hedging and speculation" (2.43). Construct F ranked as the second highest (Table 1) priority area of need in the Agribusiness Systems pathway constructs, using GMWDS, indicating a potential area of focus for agricultural educators in South Carolina.

Within the **Animal Systems** pathway the top three MWDS scores for Animal Systems variables included "Describe the use of vaccination and immunization in the animal science industry" (1.49), followed by "Select proper routes of administration of medications and



vaccines on various animal species” (1.33), and “Describe symptoms of common nutrient deficiencies” (1.33). The top three MWDS data revealed the highest need for variables within construct C, “Is familiar with proper health care of animals.” High need variables within construct C, when analyzing the top three variables, included “Describe the use of vaccination and immunization in the animal science industry” (1.49) and “Select proper routes of administration of medications and vaccines on various animal species” (1.33). Construct C had the highest (Table 2) GMWDS in the Animal Systems Pathway constructs.

Within the **ENR Systems** pathway, the top three MWDS scores for ENR included “Explain the importance of an indicator species” (1.97), followed by “Describe population sampling techniques (e.g., quadrant sampling, electrofishing in aquatic systems, radio tracking)” (1.62), and “Describe best management practices and explains how they benefit the environment (e.g., stocking rate, protection of critical wildlife habitat)” (1.37). The top three MWDS data revealed a high need for variables within construct K. “Is familiar with procedures used to develop an environmental and natural resource management plan.” High need variables within construct K, when analyzing the top three variables, included “Explain the importance of an indicator species” (1.97) and “Describe population sampling techniques (e.g., quadrant sampling, electrofishing in aquatic systems, radio tracking)” (1.62). Construct K. ranked third highest (Table 3) priority area of need in the ENR pathway constructs, using GMWDS.

Within the **Plant Systems** pathway the top three MWDS scores for Plant Systems variables included “Explain soil structure and texture as related to plant growth” (1.18), followed by “Define hazardous plant classifications (e.g., noxious, invasive) (1.17), and “Identify the macronutrients and micronutrients needed for plant growth” (1.09). The top three MWDS data revealed a high need for variables within construct F, “Know the basic characteristics of both soils and growing media and their uses” High need variables within construct F, when analyzing the top three variables, included “Explain soil structure and texture as related to plant growth” (1.18) and “Identify the macronutrients and micronutrients needed for plant growth” (1.09). Construct F. ranked third highest (Table 4) in priority area of need in the Plant Systems pathway constructs, using GMWDS. Overall agricultural education teachers in South Carolina report having high competency in the Plant Systems pathway.

Within the **Power, Structural, and Technical Systems** pathway the three top MWDS scores for Power, Structure, and Technical Systems variables included “Describe the basic operating principles of an electric motor” (3.80), “Explain how GPS and GIS are used in precision agriculture” (3.67) and “List the common applications of GPS technology in agriculture” (3.67). The top three MWDS data revealed a high need for variables within construct K. “Is familiar with the application of technology to the agriculture industry”. High need variables within construct K., when analyzing the top three variables, included “Explain how GPS and GIS are used in precision agriculture” (3.67) and “List the common applications of GPS technology in agriculture” (3.67). Construct K. ranked highest (Table 5) in priority area of need in the Power, Structural, and Technical Systems pathway constructs, using GMWDS. It is important for teacher educators to be aware of these content areas of need as future professional development sessions focused on Power, Structural and Technical Systems are designed.

Within the **Leadership and Career Development** pathway the three top MWDS scores for the Leadership and Career Development variables included “Develop a career plan to meet career goals (e.g., education, employment, lifestyle goals) (1.60), followed by “Describe the various components related to job preparation (e.g., resume development, interviewing, and overall business etiquette) (1.39), and “Describe how to determine validity and reliability of a

source (e.g., author, date, bibliography, type of source) (1.36). The top three MWDS revealed a need for variables within construct B, “Know the foundational areas of career development.” High need variables within construct B, when analyzing the top three variables, included “Develop a career plan to meet career goals (e.g., education, employment, lifestyle goals) (1.60) and “Describe the various components related to job preparation (e.g., resume development, interviewing, and overall business etiquette) (1.39). Construct B (Table 6) ranked highest in priority of need in the Leadership and Career Development pathway constructs, using GMWDS.

Previous research on professional development needs of agricultural education teachers has not specifically focused on the content knowledge of the respondent as they relate to the AFNR standards. Social cognitive theory posits one acts on their judgement about what they can do (Bandura, 1986). One’s confidence and intent to teach concepts is somewhat dependent upon their self-efficacy towards the topic. Understanding content area needs of agricultural education teachers could provide implications for change in state-wide professional development and one’s intent to participate in such programs. The results of this study provided us with information to assist with a curricular review of our undergraduate agricultural education program at Clemson University. Relevant to the findings for the need to increase content knowledge in the Agribusiness Systems pathway, we have considered the addition of an agribusiness course in the undergraduate agricultural education programs’ plan of study.

We recommend use of the instrument designed in this study, by the 24 states that require the ETS Praxis II Agriculture (5701) Exam for certification, to analyze agricultural educator’s perceived importance and competency of content knowledge, in an effort to target future professional development programs and curricular changes for those agricultural education teacher preparation programs. As research is collected among various states, teacher’s needs could be compared, and overarching professional development needs could be identified and presented regionally and nationally. The results of these studies could be useful in developing curricular change for teacher preparation programs and high quality professional development for in-service teachers. The National Association of Agricultural Educators (NAAE) may benefit from these results to plan for their annual conference. One recommendation for practice is to utilize the findings of this research to assist in gauging perceived areas of strength and weakness in content knowledge of both pre-service and in-service agricultural education teachers in South Carolina, focusing on the highest areas of need in each of the seven pathways and more specifically the Agribusiness Systems pathway.

## References

- Bandura, A. (1986). *Social foundations of thought and action: A social cognitive theory*. Englewood Cliffs, NJ: Prentice Hall.
- Barrick, R. K., Ladewig, H.W., & Hedges, L.E. (1983). Development of a systematic approach to identifying technical in-service needs of teachers. *Journal of the American Association of Teacher Educators in Agriculture*, 24(1), 13-19. doi:10.5032/jaatea.1983.01013
- Birkenholz, R. J., & Harbstreit, S. R. (1987). Analysis of the in-service needs of beginning vocational agriculture teachers. *Journal of the American Association of Teacher Educators in Agriculture*, 28(1), 41-49. doi:10.5032/jaatea.1987.01041
- Borich, G. D. (1980). A needs assessment model for conducting follow-up studies. *Journal of Teacher Education*, 31(3), 39-42.
- Carl D. Perkins Career and Technical Education Improvement Act of 2006, S. 250, 109th Cong. (2006).
- Claycomb, D.M., & Petty, G.C. (1983). A three year longitudinal study of the perceived needs for assistance as ranked by vocational agriculture instructors. *Journal of the American Association of Teachers in Agriculture*, 24(4), 28-33. doi:10.5032/jaatea.1983.04028
- Cline, R.W. 1963. Some guidelines for teacher education. *Journal of the American Association of Teacher Educators in Agriculture*, 4(2), 11-14.
- Duncan, D.W., Ricketts, J.C., Peake, J.B., & Uessler, J. (2006). Teacher preparation and in-service needs of Georgia agriculture teachers. *Journal of Agricultural Education*, 47(2), 24-35. doi:10.5032/jae.2006.02024
- Estepp, C. M., Stripling, C.T., Conner N. W., Giorgi, A. & Roberts, T. G. (2013). An examination of the learning activities, cognitive level of instruction, and teacher immediacy behaviors of successful instructors in a college of agriculture. *Journal of Agricultural Education*, 54(2), 15-28. doi:10.5032/jae.2013.02015
- ETS PRAXIS. Technical Manual for *The Praxis Series* and Related Assessments, Princeton, N.J., 2015. Retrieved from: [https://www.ets.org/s/praxis/pdf/technical\\_manual.pdf](https://www.ets.org/s/praxis/pdf/technical_manual.pdf)
- Flippo, R. F. (2002). Repeating history: Teacher licensure testing in Massachusetts. *Journal of Personnel Evaluation in Education*, 16(3), 211-229.
- Golden, M.E., Parr, B., & Peake, J. (2014). An Assessment of the Needs of Middle School Agricultural Education Instructors in Georgia. *Journal of Agricultural Education*, 55(5), 222-234. doi:10.5032/jae.2014.05222

- Hillison, J. (1977). The concerns of agricultural education preservice students and first year teachers. *The Journal of the American Association of Teacher Educators in Agriculture*, 18(3), 33-39.
- Honeycutt, M. (2015, September 3). National Council for Agricultural Education Releases Revised Content Standards. [Blog post]. Retrieved from <http://blog.careertech.org/?p=11840>
- Joerger, R. (2002). A Comparison of the in-service education needs of two cohorts of beginning Minnesota agricultural education teachers. *Journal of Agricultural Education* 43(3), 11-24. doi:10.5032/jae.2002.03011
- Kahler, A.A. (1974). Organization and instructional problems of beginning teachers of vocational agriculture. Ames: Iowa State University, Department of Agriculture Education.
- Layfield, K. D., & Dobbins, T.R. (2002). In-service needs and perceived competencies of South Carolina agricultural educators. *Journal of Agricultural Education*, 43(4), 46-55. doi:10.5032/jae.2002.04046
- National Council for Agricultural Education. (2009). Agriculture, food and natural resources (AFNR) career cluster content standards. Retrieved from [http://www.jerseyageducation.nj.gov/agriculture/ag\\_ed/classroom/FINAL%20AFNR%20Standards%20v3%202%204%206%2009.pdf](http://www.jerseyageducation.nj.gov/agriculture/ag_ed/classroom/FINAL%20AFNR%20Standards%20v3%202%204%206%2009.pdf)
- Schunk, D., H. (2012). *Learning theories: An educational perspective* (6th ed.). Boston, MA: Pearson Education Inc.
- Shippy, R. D. (1981). Professional competencies needed by beginning teachers of agriculture/agribusiness. *Journal of the American Association of Teacher Educators in Agriculture*, 22(1), 29-34.
- The National Council for Agricultural Education. (2015). *Agriculture, food and natural resource career cluster content standards*. Retrieved from [https://www.ffa.org/SiteCollectionDocuments/council\\_afnr\\_career\\_cluster\\_content\\_standards.pdf](https://www.ffa.org/SiteCollectionDocuments/council_afnr_career_cluster_content_standards.pdf)
- Thobega, M & Miller, G. (2008). Predicting scores of beginning agricultural education teachers on the Praxis II examination. *Journal of Agricultural Education*, 49(1), 99-109. doi:10.5032/jae.2008.01099
- Valli, L. (1992). Beginning teacher problems: Areas for teacher education improvement. *Action in Teacher Education*, 14(1), 18-25.
- Veeman, S. (1984). Perceived problems of beginning teachers. *Review of Educational Research*, 54(2), 143-178.



## **General Education Plant Pathology Course Increases Science Identity Among Undergraduates in Live and Online Sections**

Kathryn A. Stofer, University of Florida  
Brantlee Spakes-Richter, University of Florida  
Natalie Del Rocco, University of Florida  
Marilyn Boamah, University of Florida

### **Abstract**

The supply of science, technology, engineering, and math (STEM) jobs in the United States, particularly within agriculture, currently outpaces the number of qualified applicants. Efforts to promote agriculture as a career include opportunities especially at land-grant universities to fulfill general education science requirements in agriculture colleges. These courses may reach large numbers of students and provide real-world context that increases their intent to pursue these careers. One factor affecting student career choice is identity. We use a 12-item Likert-scale instrument to measure science identity in students enrolled in a general education plant pathology course at a large university in the southeastern region. We found differences among students in live and online versions of the course, among gender, and among ethnic groups at both pre-test at the beginning of the course and post-test at the end of the course. We show that this instrument can be a tool for identifying groups that may benefit from particular attention as well as ways courses may impact groups differently on this affective measure related to career choice.

### **Introduction**

The United States is actively engaged in efforts to expand and reform science, technology, engineering, and math (STEM) education to prepare the next generation workforce (Carnevale, Smith, & Melton, 2011; Goecker, Gilmore, Smith, & Smith, 2005; Goecker, Smith, Smith, & Goetz, 2010; Langdon, McKittrick, Beede, Khan, & Doms, 2011; STEMconnector, 2014; United States. Congress. Joint Economic Committee Chairman, 2012; Vilorio, 2014). As part of this effort, agricultural educators are also working to increase the number of students who enter college and pursue agriscience or Ag-STEM careers through re-emphasized agriculture and STEM connections (Chumbley, Haynes, & Stofer, 2015; Enderlin & Osborne, 1992; Hillison, 1996; Myers, Thoron, & Thompson, 2009; Myers & Washburn, 2008). General education undergraduate courses taught by agricultural science faculty may provide an opportunity to recruit students with or without a general interest in STEM fields into Ag-STEM programs (Powell & Harmon, 2014). For students who are not considering further studies in STEM fields, general education science courses also provide a vehicle to teach STEM topics within an applied context, which can serve to make science more approachable for non-science majors (Kastens, 2010; Rutledge, Bonner, & Lampley, 2015; Vitone et al., 2016). General education courses within Ag-STEM programs also provide an opportunity to generate interest in agricultural issues among future voters, business leaders, and public servants, for whom required general education credit courses are likely to be the last formal science education in which these non-majors engage.

While many researchers focus on Ag-STEM cognitive preparation, recent research agendas at the national level are increasingly recognizing that affective characteristics such as attitude, identity, and career aspirations are equally crucial components of student persistence (see for example: the Federal Science, Technology, Engineering, and Mathematics (STEM) Education 5-Year Strategic Plan (2013), the National Academy of Engineering and National Research Council “STEM Integration in K-12 Education: Status, Prospects, and an Agenda for Research” (2014), and the American Association of Agricultural Educators’ own National Research Agenda (Doerfert, 2011)). As science identity in particular becomes better defined and understood (Brown, 2004; Carlone & Johnson, 2007; Chang, Eagan, Lin, & Hurtado, 2011; Chemers, Zurbriggen, Syed, Goza, & Bearman, 2011; Eagan, Hurtado, Garibay, & Herrera, 2012; Wolfe, 2013), we are beginning to apply the tools previously used to study student success and persistence in so-called “basic” STEM disciplines to those in “applied” Ag-STEM disciplines as well. In this study, we use a novel quantitative science identity instrument designed with chemistry undergraduates to study aspects of science identity among students in a general education course taught within a Plant Pathology department at a large, comprehensive, four-year public university. In addition to measuring science identity parameters before and after completion of a highly-applied, agriculturally-centered biology credit course, we have applied this instrument to examine potential identity differences between live and online delivery of the same course content and among various demographic groups.

### **Conceptual Framework: Science Identity**

Researchers now widely recognize the development of a science identity as a major factor in students’ attraction to and persistence in STEM fields of study (cf. Brown, 2004; Carlone & Johnson, 2007; Chang et al., 2011; Chemers et al., 2011; Eagan et al., 2012; Wolfe, 2013). As summarized by Carlone and Johnson (2007), “cultivating short-term knowledge and interest are not enough to develop sustained interest in science.” As we search for ways to recruit students into STEM fields, improve STEM education for those students currently pursuing these subjects, and retain those students as productive members of the workforce in STEM careers, we now recognize that our standard cognitive measures of student success in the classroom are insufficient predictors of science identity development and long-term sustaining interest in scientific pursuits; we must also consider affective characteristics in order to complete the picture and understand the factors that lead to either success or attrition.

Identity development results from interactions between internal and external factors. For example, one of the key internal factors in identity is self-efficacy, the person’s belief that he or she is able to master events within his or her life (Bandura, 1977; Glynn, Taasoobshirazi, & Brickman, 2009)). Self-efficacy is crucial to major and career choices among college students (Chemers et al., 2011; Kier, Blanchard, Osborne, & Albert, 2014), and its development in a person can be greatly influenced by the external factor of recognition by others (Wolfe, 2013). Further, the impact others’ opinions varies greatly, depending upon factors such as the type of person giving the opinion and the value placed on that type of person (Eisenhart & Finkel, 1998).

A science classroom serves as a platform upon which participants engage in learning, and in the development and expression of their science identities. Wenger (2010) views these activities as intertwined, with learning as a production of identity, and identity as a multi-faceted

layering of events and interpretations, informed by involvement in a community experience. When identity is seen as a flexible and dynamic construct, the possibility of changing or altering the identity or a specific identity, such as science, emerges. For example, if students take a course that broadens their minds about science or allows them to become less apprehensive about science, students are more likely to become involved in other science areas and explore those areas. This exploration of science could lead to a stronger performance and competence in science, which could boost a student's self-recognition as a scientist, thus effectively increasing a student's science identity. As Wenger (2010) also notes, this flexibility allows for both positive and negative outcomes: "a community of practice can be dysfunctional, counterproductive, even harmful" (pp. 180–181). Over time, for better or worse, a person's performance, participation patterns, and expectations become habitual; identity is thus both contingent on situations and also something that can become stable, if the same patterns are habitually carried across time and context (Elmesky & Seiler, 2007; Roth, 2006). Identity can then be seen as semi-flexible, which means initial perceptions and conceptions about one's self and identity in science can change, and that cumulative experiences shape a more stable long-term identity framework.

For this study, we used the model of science identity comprised of competence, performance, and recognition, as conceived by Carlone and Johnson (2007) and operationalized in the Likert-type items of Wolfe (2013, used with permission). Standard in-class assessments, for the purposes of building knowledge and comprehension (formative) and assigning course grades (summative), are necessarily based upon measures of competence and performance. Recognition is the component that addresses the critical question of whether or not the student self-identifies as a "science person," and whether that identity is also accepted and reinforced externally. Within a person's overall identity, Carlone and Johnson's (2007) science identity relates these individual components of identity to science and to science information, techniques and cultural expectations within the science world. This type of identity represents a part of a student's overall identity and may relate to choices he or she may make, especially about pursuing a science or science-related career (Aschbacher, Li, & Roth, 2010; Carlone & Johnson, 2007; Chemers et al., 2011).

### **Science interest, persistence, and course delivery**

The most recent analysis of student retention rates in STEM undergraduate degree programs based on students entering college between 1971 and 2009 showed that the number of students entering four-year colleges with intent to pursue a STEM field major has been relatively stable since the mid-1990s, with between 30 and 35% of entering freshmen aspiring to pursue STEM degrees (Higher Education Research Institute at UCLA, 2010). However, as of 2009 (2004 freshmen), fewer than 40% of those aspiring students actually completed a STEM degree within 5 years, and there were large gaps in completion rates among racial/ethnic groups. Many studies have examined the factors behind attrition from STEM interests at both the secondary school and college levels (e.g. Ackerman, Kanfer, & Beier, 2013; Ashford, Lanehart, Kersaint, Lee, & Kromrey, 2016; Dika & D'Amico, 2016; Herrera, Hurtado, & Chang, 2011; Herrera, Hurtado, Garcia, & Gasiewski, 2012; National Academy of Engineering & National Research Council (U.S.), 2014; National Commission on Excellence in Education, 1983), and traditional so-called "pipeline" models suggesting early development of science identity (e.g. Herrera et al., 2011) are challenged by models with evidence of emergence as a scientist during undergraduate



years (Cannady, Greenwald, & Harris, 2014; Eagan et al., 2012; Hurtado, Eagan, & Sharkness, 2009). In both cases, a look at the teaching methods and learning experiences of students may provide some answers as to why students may move towards or away from STEM fields of study. Although many factors behind science identity are cultural and therefore institutionalized beyond the classroom, these factors can be either reinforced or ameliorated through students' experiences in their STEM courses (Aschbacher, Li, & Roth, 2010; Carlone & Johnson, 2007; Wenger, 2010; Wolfe, 2013).

Classroom structures and the style of teaching in many STEM courses have been found to detract from an interactive and engaging learning experience for students (Blumenfeld, Kempler, & Krajcik, 2006; Freeman et al., 2014; Glynn et al., 2009; Wolfe, 2013). For example, lecture halls that include hundreds of students per section typically create an unengaging learning experience, as students are expected to sit and listen to a lecturer while taking notes. This method of "spoon-feeding" information without any involvement of the learner can make the learner feel as though the information is irrelevant to them or uninteresting. If a person is unmotivated to learn, this can be a major roadblock to learning and to the development of interest in STEM fields. In fact, the most common reason that students cite for abandoning a STEM field of study is loss of interest (Seymour & Hewitt, 1997), which suggests that motivation does play a part in retention in STEM fields. This self-identified loss of interest is also likely related to external influences on science identity in the form of negative feedback from early attempts to engage in STEM disciplines: poor performance in first-year STEM courses is one of the most significant empirical factors in student attrition from these fields (Chen & Soldner, 2013; Rask, 2010).

The current project features an interdisciplinary course with a curriculum that draws from the scholarship in multiple fields, one characteristic of engaging courses. The course in our study may be used to meet either a biology or a humanities credit under the university's general education requirements. The goal of this course, as with most courses with this type of interdisciplinary approach, is to integrate the contributions of different academic fields so that topics under study are contextualized and understood better (Lattuca, Voigt, & Fath, 2004). Interdisciplinary courses offer much needed real-world context for typically abstract science content (Rivet & Krajcik, 2008), increasing students' sense that the material is personally relevant. These courses, including agriscience courses, help students develop the ability to see and employ multiple perspectives, thus encouraging tolerance and respect for the perspectives of others and expanding horizons (Enderlin & Osborne, 1992; Hillison, 1996; Lattuca et al., 2004; Rivet & Krajcik, 2008; Ross, Hooten, & Cohen, 2013). These advantages of interdisciplinary content make this type of course a good candidate for examining development of science identity; although previously examined only in terms of content gain, approaches which improve students' perceptions of relevance and personal context should also improve affective measures.

To date, research on science identity in college education has focused largely on the factors that impact identity development and on the role of identity in student success (e.g. Brown, 2004; Chang et al., 2011; Chemers et al., 2011; Eagan et al., 2012). The advent of online education has added complexity to these lines of inquiry, as the online atmosphere typically presents an entirely different way of engaging with both content and community. If large lecture halls and one-way communication of content are factors in faltering student motivation, sense of belonging, and general interest, what will be the impacts of entirely removing face-to-face

interactions from the learning equation? How do students build a science identity when the learning community is relegated to electronic messages and discussion forums? Student outcomes have been compared between online and live in person sections for multiple courses, and have generally found that content retention is similar between these broad format types (Ali & Smith, 2014; Dominguez-Flores & Wang, 2011; Ledman, 2008; Neuhauser, 2002). Just as interactive approaches have been found to increase student success in in-person courses (Freeman et al., 2014), consistent communication and building community online to foster interaction have been found to increase success in online courses (Cuellar, 2002; Swan, 2002). Although these approaches have implicit impacts on science identity due to underlying effects on self-efficacy for example, there has yet been no research comparing aspects of science identity between online and in-person delivery modes. The course used in the current research has both online and in-person sections, which provides an opportunity to explicitly examine questions of science identity formation in both formats.

### **Purpose and Objectives**

The purpose of this study is to characterize the science identity of undergraduates, both STEM majors and non-majors, in an agriculture-based interdisciplinary general education course, to compare identity scores between students in live and online sections. Due to the short duration of the course and lack of direct intervention on science identity, for this initial analysis we look at individual questions rather than larger constructs within science identity to detect potential changes.

The objectives of this project were to:

- 1) measure overall science identity scores and individual science identity question scores among undergraduate students in a general education course, taught from within an agricultural sciences college at a large public university;
- 2) determine which overall averages and which component aspects based on individual questions of science identity changed from the beginning to the end of the course;
- 3) identify any differences in science identity averages between live and online sections of the course and among demographic groups.

We hypothesize that undergraduate students in a general education course will have varying science identities which reflect both their backgrounds and their declared majors. We further hypothesize that science identities among undergraduates are malleable, and that identity will change from the beginning to the end of a semester. We also hypothesize differences exist in identity between live and online course sections at the beginning, but not the end of the course.

### **Methods**

We collected data from students in two courses at a large public very high research university (Center for Postsecondary Research, Indiana University, n.d.) in the Southeastern U.S. The second author taught all courses. Students received extra credit for participation, and we therefore had high percentages of students participating (live: 67%, online: 55%). Course 1 is an interdisciplinary general education course, which can be taken for either biology or humanities

general education credit, offered live during the summer session and online during the spring session. The second author taught live courses of between 116 and 137 students each year in a large lecture hall in a primarily lecture-based format that included numerous short break-out discussions and occasional voluntary role-playing demonstrations. The online course was designed to be as similar to the live course as possible, using video lectures supported by flash-based interactive exercises, other multi-media components, and four required discussion board assignments.

In addition to this course, we collected data from an upper-level plant pathology course (course 2), which draws students from many different biological and agriscience majors such as biology, entomology, horticulture, agronomy, and natural resource conservation. This course served as a control, to verify that the Wolfe (2013) tool as adapted could detect clear differences between mostly lower-division general education students, who are not expected to have formed a strong science identity, and upper division science majors, who are expected to have very strong science identities.

Students in Course 2 completed the survey instrument only once, toward the end of the course. Students in Course 1 completed the instrument twice, once at the beginning of the course and once toward the end. The end-of-course instrument included a retrospective pre-test starting in 2015 (Campbell, Stanley, & Gage, 1963), so that both students who completed the instrument at the beginning of the semester and those who did not could participate in the post-test. We collected data from Course 1 in Spring and Summer 2014-16, except we did not collect data from the live course in Summer 2016; we collected data from Course 2 in Fall 2013 and 2014.

### **Quantitative science identity scale and overall instrument**

The science identity scale used for this project is from Wolfe (2013). Wolfe's instrument was based on a combination of Identity Theory (Burke & Stets, 2009; McCall & Simmons, 1978; Tajfel, 1978) and Student Development Theory (Chickering, 1969). The questions focus specifically on science identity by incorporating concepts from Carlone and Johnson (2007), who interviewed female scientists of color about their identity development. Wolfe's survey instrument was administered to a total of 1706 students in a course for chemistry majors and in two general chemistry courses intended for a wider variety of students at a large research university in the Pacific Northwest (Wolfe, 2013). Wolfe tested the instrument for reliability and validity with those students. Results showed students majoring in chemistry had higher mean responses to all items on the Science Identity instrument than did students in the general chemistry courses (Wolfe, 2013). Wolfe also found associations with identity scores and gender, high school physics experience, and types of messages about scientists that students received as youth.

Our instrument included the 12-item Likert-type scale science identity questionnaire, a 12-item Likert-type scale humanities identity questionnaire, and a demographic questionnaire. Humanities identity results are not discussed further here and are descriptions of the questions are only included for instrument description. The science identity questions were taken from Wolfe (2013). Items included "I like to think I am good at doing science," "Other people consider me to be a science person," and "I want to belong to a scientific community." For the

humanities identity questions, instances of the word “science” in the questions were replaced with the word “humanities.” Each of the identity scales were 5-point scales labeled Strongly Disagree (1), Disagree, Neither Agree nor Disagree, Agree, and Strongly Agree (5). We tested internal reliability using Cronbach’s alpha. Survey questions were written with regard to Carlone and Johnson’s science identity elements. Instrument questions 3, 5, 9, and 13 fit “performance”. Questions 2, 7, and 11 – “competence”, and questions 1, 4, 6, 8 and 10 – “recognition”. Analysis of data from both the online and in-person data validated that these groups of questions are internally consistent ( $\alpha \geq 0.70$ ).

Science identity and humanities identity questions were each presented to participants as a block; participants were randomly assigned the science or humanities block first through Qualtrics software used to administer the web-based survey. The order of administration of the block of questions did not show a significant effect on science identity scores ( $p > .10$ ). The science identity questions were confirmed by the plant pathology instructor, the second author, as having face and content validity for the students based on the course content. The demographics section asked participants about their perceived high school performance in high school chemistry, biology, physics, and other science courses, as well as their recent college (as the university accepts a large number of transfer students) and mathematics background. Participants were asked about their major, grade level, whether and how much they work for pay or volunteer, whether they care for children, and their racial, ethnic, and gender identification. The first and fourth authors classified STEM and STEM-related careers using their own knowledge as a professor and undergraduate STEM student; we were liberal in our definition, including both medical, physical/occupational therapy, and social sciences in STEM, but excluding for example business, humanities, education, and tourism/hospitality. We considered undeclared/blank answers separately, but if students listed a STEM-related potential career, we classified their careers as STEM-related even if their major was blank or non-STEM, and vice versa. For each category, we decided students’ majors or careers were STEM-related if they listed at least one STEM-related major or career.

We used the open source statistical package *R*, version 3.4.1, for all analyses except as noted. We averaged the scores from the 12 individual items on science identity scale into a single score for each participant and used paired t-tests to examine pre- and post-test identity scores overall in each course each session. We compared the students from each subsequent year to each other using ANOVA; finding no significant differences among them, we pooled the data for analysis by course type. To compare group differences by demographic, we used least squares means analysis (Lenth, 2016) to account for disparities in group sizes. For example, in the online section of the course, 135 students identified as male on the pre-test, while 228 students identified as female. We analyzed all pairwise comparisons using the Tukey multiple comparison procedure at  $\alpha = 0.05$ . In addition, we examined individual question scores in the pre- and post-test by course using paired t-tests. Using these methods, we compared the groups of interest described in the objectives. For 2014-15 students, we calculated reliability using Cronbach’s alpha to be 0.91, compared to 0.92 with the chemistry students (Wolfe, 2013).

We ran the analysis using only those students who completed both the before and after instrument, omitting students in the online course who were more than a week ahead of the course schedule, and using final grades with the bonus points excluded. Students who took the

instrument had an average final grade 3.6% above those who did not (2-tailed t-test,  $p = 0.05$ ). Two sections of the live course 1 and three sections of the online course 1 are included in this study, for a total of 170 and 298 students, respectively, with 53 control students in Course 2. For the paired t-tests, the sample sizes enable us to detect effect sizes of 0.5 with power .74 and .93 respectively at  $\alpha = 0.05$ , using G\*Power 3.1 for Mac.

## Results

### Objective 1

Our first objective was to describe the science identities of students enrolled in the general education courses. We found a range of identities as expected, among students overall and among demographic groups. Individual student pre-test scores ranged from 1.17 to 4.83 (on a scale of 1 to 5) in the live course, 1.25 to 5.0 in the online course. In the post-test, individual student scores went from 1.92 to 5 in the live course and 1.08 to 5 in the online course. The lowest overall group average pre-test identity was among Black students in the online course, 2.84 out of 5, while the highest overall group average pre-test identity was among males (3.7) and Asians (3.74) in the live course. These patterns persisted in the post-tests, though the scores were generally higher in the post-test than in the pre-test. See Table 1. Results from individual questions will be discussed in the context of Objective 2 in the next section.

### Objective 2

Our second objective was to determine changes in science identity overall and on individual questions from the beginning to the end of the course. In the live course ( $n = 170$ ), overall average score increased significantly from the beginning (3.49) to the end of the course (3.64),  $p < 0.01$ . See Table 1. In addition, we observed significant increases in average scores in seven of the individual items, all  $p < .05$ : “I feel a connection to the scientific community” (3.44 to 3.75); “My hobbies are often science related (books, television, or activities)” (3.11 to 3.34); “I consider myself to be a science person” (3.25 to 3.38); “Learning science concepts often comes easy to me” (3.38 to 3.56); “I am often encouraged by others to pursue science” (3.39 to 3.63); “Other people (my family, friends, teachers) frequently consider me to be a science person” (3.19 to 3.41); “I consider most of my friends to be science people” (3.05 to 3.26).

In the online course ( $n = 298$ ), the overall average science identity did significantly change between the beginning and end of the course ( $p < .05$ ). Additionally, we noted significant increases in mean scores per question, all  $p < .05$ , for four of 12 items: “I feel a connection to the scientific community” (3.36 to 3.54); “I consider myself to be a science person” (3.23 to 3.35); “I consider most of my friends to be science people” (3.02 to 3.16); “I want to belong to a scientific community” (3.40 to 3.51), all elements of recognition based on Carlone and Johnson (2007). However, the average score for the question “Through their work, scientists are able to improve the lives of others and the world in which we live” decreased significantly from the beginning (4.54) to the end of the course (4.44), though it was still highly rated on the 5-point scale.

Table 1.

*Mean Pre- and Post-test Science Identity by Course and Demographics Group*

Group	Live				Online			
	Pre Score	Post Score	<i>t</i>	<i>d</i>	Pre Score	Post Score	<i>t</i>	<i>d</i>
All Participants	3.49 ( <i>n</i> = 170)	3.64 ( <i>n</i> = 170)	4.25***	0.19	3.46 ( <i>n</i> = 298)	3.52 ( <i>n</i> = 298)	2.14*	0.08
Male	3.7 ( <i>n</i> = 65)	3.82 ( <i>n</i> = 65)	2.29*	0.17	3.51 ( <i>n</i> = 88)	3.63 ( <i>n</i> = 88)	2.43*	0.17
Female	3.35 ( <i>n</i> = 103)	3.52 ( <i>n</i> = 103)	3.62***	0.21	3.45 ( <i>n</i> = 180)	3.48 ( <i>n</i> = 180)	0.94	0.03
White (Not Hispanic)	3.46 ( <i>n</i> = 103)	3.62 ( <i>n</i> = 103)	3.87***	0.20	3.4 ( <i>n</i> = 159)	3.47 ( <i>n</i> = 159)	2.1*	0.09
Black	3.43 ( <i>n</i> = 10)	3.77 ( <i>n</i> = 10)	2.56*	0.35	3.0 ( <i>n</i> = 16)	2.92 ( <i>n</i> = 16)	-0.42	0.11
Hispanic	3.53 ( <i>n</i> = 15)	3.58 ( <i>n</i> = 15)	0.75	0.06	3.57 ( <i>n</i> = 35)	3.71 ( <i>n</i> = 35)	0.89	0.18
Asian	3.74 ( <i>n</i> = 13)	3.99 ( <i>n</i> = 13)	1.83	0.37	3.61 ( <i>n</i> = 39)	3.56 ( <i>n</i> = 39)	-0.13	0.06
White-Hispanic	3.46 ( <i>n</i> = 14)	3.60 ( <i>n</i> = 14)	1.21	0.21	3.67 ( <i>n</i> = 16)	3.6 ( <i>n</i> = 16)	-0.05	0.09
Other	3.45 ( <i>n</i> = 11)	3.34 ( <i>n</i> = 11)	-0.46	0.13	3.56 ( <i>n</i> = 170)	3.8 ( <i>n</i> = 170)	1.58	0.26

Note. \*  $p < .05$ , \*\*  $p < .01$ , \*\*\*  $p < .001$ , two-tailed.

Our hypothesis was supported, as students in the online courses had lower overall scores than in the live course, and scores for all students increased from beginning to the end of the course. We fail to reject the null hypothesis of no changes.

### Objective 3

Our final objective was to identify any differences in science identity averages and between live and online sections of the course and among demographic groups. To do this, we looked at differences in pre-test scores, post-test scores, and pre-post changes.

**Online.** For students in the online versions of the course, we found several comparisons among ethnic groups to be significant at  $p < .05$ . First, both Hispanic (3.57) and Asian (3.61) students had higher pre-test identities than Black (3.0) students. Pre-test identities of Hispanic and Asian students were significantly higher than that of Black students ( $p < .05$ ,  $t = -3.41$ , and  $t = -3.36$  respectively). However, by the end of the course, the post science identity of Black

students was not significantly different from any other ethnic group (Hispanic, 3.71, Asian 3.56, Black, 2.92). Specifically, the differences noted in the comparisons of Black to Hispanic and Black to Asian in the pre-test were not present ( $t = -2.61$  and  $t = 2.39$ , respectively). We found no differences among genders in the online course in their pre-test scores.

**Live.** For students in the live offerings of the course, we again saw differences in demographic categories, but primarily for gender rather than ethnicity. In both the pre- and post-tests, male students in the live courses have significantly higher science identity than female students. Male pre-test average identity (3.7) was significantly larger than Female pre-test average identity (3.35) with  $p < .05$  ( $t = 2.8$ ). Similarly, Male post-test average identity (3.82) was significantly larger than Female post-test average identity (3.52) with  $p < .05$  ( $t = 2.52$ ). We fail to reject our null hypothesis of no differences, and our overall hypothesis about existing differences among demographic groups and among course formats was supported. The largest effect size of significant effects was found for the live section Black students' changes pre-test to post-test, though this was still a small overall effect ( $d = 0.35$ ).

### Conclusion and Implications

Overall, we saw differences in mean science identity for upper-level versus general education students and for STEM majors and non-majors. Discovering these significant differences by course and major is consistent with the chemistry students in Wolfe (2013). Coupled with the similar reliability of the scale for these students, these findings lend support to the notion that the instrument used for this project measures what we want it to for agriscience students. Our hypotheses about science identity among live and online courses and among demographic groups were supported, as we failed to reject our null hypotheses of no differences.

We measured science identities in the range of approximately 3 - 4 points on a 5-point scale, meaning our students were slightly more likely than not to identify as science people. However, the majors in Course 2 had higher overall science identities as may be expected of students who are actively pursuing STEM degrees and who are in upper-level courses. We also did not separate in this study STEM majors from non-STEM majors; presumably in our sample we would have some non-STEM majors with lower identities, maybe dipping below the middle of our 5-point scale in some cases. We did see that while science identities increased overall from the pre- to the post-test, some groups had slight decreases. We also found that identities overall in the online course were lower than in the live course.

In the live section of the course, the differences were among gender groups. Pre science identity of Male students is significantly higher than that of Female students and persists through the post-test. However, both groups' average science identity increased and the gap did narrow somewhat from the beginning to the end of the course.

In the online section, the results showed that disparities in science identity among ethnic groups which are present at the beginning of the course become insignificant by the end of the course. Notably, we saw that Black students had significantly lower pre-test science identity than most other minority groups, but the difference was erased by the end of the course. However, we saw the science identity of the Black, Asian, and White Hispanic students in the online course

decline from pre- to post-test, which may indicate they changed their ideas of what science was from the beginning to the end of the course, and may have actually improved their identity scores if we examine retrospective pre-test scores, which may have been even lower. It may also indicate a lack of engagement of the online course format which was not present in the live presentation. However, if the retrospective pre-test scores do show lower starting identity recognized at the end of the course, then, the post-test lack of difference among ethnic groups may suggest that the course is closing gaps between ethnic groups' science identities regardless of concerns with the course delivery.

Potential limitations of the study include that the respondents may have been motivated to earn extra credit because they had higher science identities and thus wanted to maintain a higher grade than those who did not participate. This could be the case as we did see that participants who completed both the pre- and post-test had higher grades than non-respondents. However, we had robust participation rates overall, and students were invited through their required online course platform, minimizing non-response bias. We also cannot ensure that the year in school of the students does not affect science identity. General education courses may be taken at any point in one's undergraduate career, so the students in were distributed across all grade levels.

### **Recommendations for Future Research**

Further analysis will allow us to examine the influence of year in school on identity development and maintenance during college (Cannady et al., 2014; Herrera et al., 2011). Finally, students in higher grade levels and who are pursuing STEM majors may be frustrated with the material, thinking it "beneath" them, thus affecting their identity scores. As they are developing their own science identities, their desire to associate with science may actually be harmed if they feel that their competence in science is being underestimated.

Future work in this project involves studying larger populations of students in order to be able to further sub-divide courses by specific major, year in school, ethnicity, gender, anticipated career, and high school science preparation; for many of these categories we had too few respondents for higher-level analyses. We will also examine the effectiveness on identity change of another course by the same instructor, a small live course offered for both humanities and science general education credit and incorporating more sophisticated student engagement strategies than the lecture-style courses reported here.

Increasing our sample sizes will also allow us to detect smaller effects among groups as well as have more power, particularly for the live course. While some of our results showed statistical significance, we are also interested in the practical significance of our results. The instructor has made some changes to increase interaction in the lecture-style course, but she could introduce more strategies and hope to see larger practical changes, in the range of a point or more (25%) in science identity over the length of the courses to truly show effective ways to address recruitment in general education students.

We will also examine identity development in other agriscience upper-level and general education courses in plant pathology and other specialties. We will correlate the identity results



with student final course grades. We will examine the usefulness of the instrument at assessing the effectiveness of particular educational interventions such as course format before and after reform. Finally, with greater numbers of participants in the study, we can examine the sub-scores from the new instrument tied to particular components of Carlone and Johnson's (2007) model: competence, performance, and recognition, in order to determine whether students score consistently across the three areas and whether the courses differentially affect one or more components. If not, we may be able to target particular interventions to address the individual components.

## **Discussion**

This research gives us a better and more complete view of science identity and clues to the effects of course structure on students' science identities. In the end, we demonstrate this instrument may be an effective way to quantitatively study the affective component of science identity within agriculture students pursuing undergraduate science majors. Ultimately this will help researchers and educators working to encourage Ag-STEM persistence and career choice.

This project is significant to the field of agriscience education in two ways. Science identity research is emerging as an affective measure to complement cognitive measures predicting student persistence in science and agriculture careers (Adams, Hean, Sturgis, & Clark, 2006; Brown, 2004; Carlone & Johnson, 2007; Chang et al., 2011; Chemers et al., 2011; Chumbley et al., 2015; Eagan et al., 2012; Herrera et al., 2011; Hurtado et al., 2009), and a new quantitative instrument has been developed to characterize science identity in undergraduates (Wolfe, 2013). This project examines students in a general education course taught from within an agriscience department in a college of agriculture and life sciences. The department and college share a highly applied approach to science, which distinguishes them from most biology, chemistry, and physics departments within liberal arts and sciences colleges (Hillison, 1996). By examining the applicability of this instrument with a new population, we are adding to the credibility of a novel science identity instrument. Secondly, this is the first study to examine the impacts of a single course on science identity, comparing live and online sections of the same course. The differences that emerge between students accessing the same course, with the same professor, through live versus online platforms provides a foundation for future examinations of identity development online education and improvement of online formats to achieve not only cognitive, but also affective parity.

## References

- Ackerman, P. L., Kanfer, R., & Beier, M. E. (2013). Trait complex, cognitive ability, and domain knowledge predictors of baccalaureate success, STEM persistence, and gender differences. *Journal of Educational Psychology, 105*(3), 911–927. <https://doi.org/10.1037/a0032338>
- Adams, K., Hean, S., Sturgis, P., & Clark, J. M. (2006). Investigating the factors influencing professional identity of first-year health and social care students. *Learning in Health & Social Care, 5*(2), 55–68. <https://doi.org/10.1111/j.1473-6861.2006.00119.x>
- Ali, A., & Smith, D. (2014). Comparing students' performance in online versus face-to-face
- Aschbacher, P. R., Li, E., & Roth, E. J. (2010b). Is science me? High school students' identities, participation and aspirations in science, engineering, and medicine. *Journal of Research in Science Teaching, 47*(5), 564–582. <https://doi.org/10.1002/tea.20353>
- Ashford, S. N., Lanehart, R. E., Kersaint, G. K., Lee, R. S., & Kromrey, J. D. (2016). STEM pathways: Examining persistence in rigorous math and science course taking. *Journal of Science Education and Technology, 25*(6), 961–975. <https://doi.org/10.1007/s10956-016-9654-0>
- Bandura, A. (1977). Self-efficacy: Toward a unifying theory of behavioral change. *Psychological Review, 84*(2), 191–215.
- Blumenfeld, P. C., Kempler, T. M., & Krajcik, J. S. (2006). Motivation and cognitive engagement in learning environments. In *The Cambridge Handbook of the Learning Sciences* (pp. 475–488). Cambridge: Cambridge University Press.
- Brown, B. A. (2004). Discursive identity: Assimilation into the culture of science and its implications for minority students. *Journal of Research in Science Teaching, 41*(8), 810–834. <https://doi.org/10.1002/tea.20228>
- Burke, P. J., & Stets, J. E. (2009). *Identity theory*. Oxford University Press. Retrieved from <http://books.google.com/books?hl=en&lr=&id=W8PmzuMCuZoC&oi=fnd&pg=PT14&dq=burke+and+stets+identity&ots=gQyPGp9UVO&sig=CZhHNsp68uWoN-oSDO2rENxOsCA>
- Campbell, D. T., Stanley, J. C., & Gage, N. L. (1963). Experimental and quasi-experimental designs for research. In *Handbook of Research on Teaching* (pp. 171–246). Chicago, IL: Rand McNally.
- Cannady, M. A., Greenwald, E., & Harris, K. N. (2014). Problematizing the STEM pipeline metaphor: is the STEM pipeline metaphor serving our students and the stem workforce? *Science Education, 98*(3), 443–460. <https://doi.org/10.1002/sc.21108>

- Carlone, H. B., & Johnson, A. (2007). Understanding the science experiences of successful women of color: Science identity as an analytic lens. *Journal of Research in Science Teaching*, 44(8), 1187–1218.
- Carnevale, A. P., Smith, N., & Melton, M. (2011). *STEM: Science, Technology, Engineering, Mathematics*. Washington, DC: Georgetown University Center on Education and the Workforce.
- Center for Postsecondary Research, Indiana University. (n.d.). The Carnegie Classification of Institutions of Higher Education. Retrieved March 4, 2015, from [carnegieclassifications.iu.edu](http://carnegieclassifications.iu.edu)
- Chang, M. J., Eagan, M. K., Lin, M. H., & Hurtado, S. (2011). Considering the impact of racial stigmas and science identity: Persistence among biomedical and behavioral science aspirants. *The Journal of Higher Education*, 82(5), 564–596. <https://doi.org/10.1353/jhe.2011.0030>
- Chemers, M. M., Zurbriggen, E. L., Syed, M., Goza, B. K., & Bearman, S. (2011). The Role of efficacy and identity in science career commitment among underrepresented minority students. *Journal of Social Issues*, 67(3), 469–491. <https://doi.org/10.1111/j.1540-4560.2011.01710.x>
- Chen, X., & Soldner, M. (2013). *STEM Attrition: College Students' Paths Into and Out of STEM Fields* (Statistical Analysis Report No. NCES 2014-001). National Center for Education Statistics, Institute of Education Sciences, U.S. Department of Education. Retrieved from <http://nces.ed.gov/pubs2014/2014001rev.pdf>
- Chickering, A. W. (1969). *Education and Identity*. San Francisco, CA: Jossey-Bass.
- Chumbley, S. B., Haynes, J. C., & Stofer, K. A. (2015). A measure of students' motivation to learn science through agricultural STEM emphasis. *Journal of Agricultural Education*, 56(4), 107–122. <https://doi.org/10.5032/jae.2015.04107>
- Cuellar, N. (2002). Tips to Increase Success for Teaching Online: COMMUNICATION! *CIN: Computers, Informatics, Nursing*, 5(1), 1.
- Dika, S. L., & D'Amico, M. M. (2016). Early experiences and integration in the persistence of first-generation college students in STEM and non-STEM majors. *Journal of Research in Science Teaching*, 53(3), 368–383. <https://doi.org/10.1002/tea.21301>
- Doerfert, D. L. (Ed.). (2011). National research agenda: American Association for Agricultural Education's research priorities for 2011-2015. Texas Tech University, Department of Agricultural Education and Communication.

- Dominguez-Flores, N., & Wang, L. (2011). Online learning communities: Enhancing undergraduate students' acquisition of information skills. *Journal of Library Administration*, 37(6), 495–503. <https://doi.org/10.1016/j.acalib.2011.07.006>
- Eagan, M. K., Hurtado, S., Garibay, J. C., & Herrera, F. A. (2012). Accentuating advantage: developing science identity during college. Presented at the Annual Conference of the American Educational Research Association, Vancouver, BC.
- Elmesky, R., & Seiler, G. (2007). Movement expressiveness, solidarity and the (re)shaping of African American students' scientific identities. *Cultural Studies of Science Education*, 2(1), 73–103. <https://doi.org/10.1007/s11422-007-9050-4>
- Enderlin, K. J., & Osborne, E. W. (1992). Student achievement, attitudes, and thinking skill attainment in an integrated science/agriculture course. Presented at the 19th Annual Agricultural Education Research Meeting, St. Louis, MO.
- Freeman, S., Eddy, S. L., McDonough, M., Smith, M. K., Okoroafor, N., Jordt, H., & Wenderoth, M. P. (2014). Active learning increases student performance in science, engineering, and mathematics. *Proceedings of the National Academy of Sciences*, 111(23), 8410–8415. <https://doi.org/10.1073/pnas.1319030111>
- Glynn, S. M., Taasoobshirazi, G., & Brickman, P. (2009). Science Motivation Questionnaire: Construct validation with nonscience majors. *Journal of Research in Science Teaching*, 46(2), 127–146. <https://doi.org/10.1002/tea.20267>
- Goecker, A. D., Gilmore, J., Smith, E., & Smith, P. G. (2005). Employment opportunities for college graduates in the U.S. food, agricultural, and natural resources system. United States Department of Agriculture and Purdue University. Retrieved from [www.faeis.usda.gov](http://www.faeis.usda.gov)
- Goecker, A. D., Smith, P. G., Smith, E., & Goetz, R. (2010). *Employment Opportunities for College Graduates in Food, Renewable Energy, and the Environment: United States, 2010 – 2015*. West Lafayette, IN: Purdue University. Retrieved from [http://www3.ag.purdue.edu/USDA/employment/Documents/USDA\\_Employ\\_Op\\_2010\\_8.pdf](http://www3.ag.purdue.edu/USDA/employment/Documents/USDA_Employ_Op_2010_8.pdf)
- Herrera, F. A., Hurtado, S., & Chang, M. J. (2011). Maintaining career aspirations in science, technology, engineering, and mathematics (STEM) among college students. Presented at the annual conference of the Association for the Study of Higher Education, Charlotte, NC.
- Herrera, F. A., Hurtado, S., Garcia, G. A., & Gasiewski, J. (2012, April). A model for redefining STEM through identity: Insights from the educational trajectories of talented STEM graduate students. Paper presented at the American Educational Research Association Annual Meeting, Vancouver, BC.

- Higher Education Research Institute at UCLA. (2010). Degrees of Success: Bachelor's Degree Completion Rates among Initial STEM Majors (HERI Research Brief). Los Angeles: University of California at Los Angeles. Retrieved from <https://www.heri.ucla.edu/nih/downloads/2010%20-%20Hurtado,%20Eagan,%20Chang%20-%20Degrees%20of%20Success.pdf>
- Hillison, J. (1996). The origins of agriscience: Or where did all that scientific agriculture come from? *Journal of Agricultural Education*, 37(4), 8–13. <https://doi.org/10.5032/jae.1996.04008>
- Hurtado, S., Eagan, M. K., & Sharkness, J. (2009). Thinking and acting like a scientist: Investigating the outcomes of introductory science and math courses. Presented at the Annual Forum of the Association for Institutional Research, Atlanta, GA.
- Kastens, K. A. (2010). Commentary: Object and Spatial Visualization in Geosciences. *Journal of Geoscience Education*, 58(2), 52–57. <https://doi.org/10.5408/1.3534847>
- Kier, M. W., Blanchard, M. R., Osborne, J. W., & Albert, J. L. (2014). The development of the STEM Career Interest Survey (STEM-CIS). *Research in Science Education*, 44(3), 461–481. <https://doi.org/10.1007/s11165-013-9389-3>
- Langdon, D., McKittrick, G., Beede, D., Khan, B., & Doms, M. (2011). STEM: Good jobs for now and the future (U.S. Department of Commerce, Economics and Statistics Administration Issue Brief No. ESA Issue Brief #03-11). Washington, DC: United States Department of Commerce.
- Lattuca, L. R., Voigt, L. J., & Fath, K. Q. (2004). Does interdisciplinarity promote learning? Theoretical support and researchable questions. *The Review of Higher Education*, 28(1), 23–48. <https://doi.org/10.1353/rhe.2004.0028>
- Ledman, R. E. (2008). Comparing student learning in online and classroom formats of the same course. *Developments in Business Simulation and Experiential Learning*, 35, 351–352.
- Lenth, R. V. (2016). Least-Squares Means: The R Package **lsmeans**. *Journal of Statistical Software*, 69(1). <https://doi.org/10.18637/jss.v069.i01>
- McCall, G. J., & Simmons, J. L. (1978). *Identities and Interactions: An Examination of Associations in Everyday Life* (Revised). New York, NY: The Free Press. Retrieved from <http://psycnet.apa.org/psycinfo/1966-10036-000>
- Myers, B. E., Thoron, A. C., & Thompson, G. W. (2009). Perceptions of the National Agriscience Teacher Ambassador Academy toward integrating science into school-based agricultural education curriculum. *Journal of Agricultural Education*, 50(4), 120–133.

- Myers, B. E., & Washburn, S. G. (2008). Integrating science in the agriculture curriculum: Agriculture teachers' perceptions of the opportunities, barriers, and impact on student enrollment. *Journal of Agricultural Education*, 49(2), 27–37.
- National Academy of Engineering, & National Research Council (U.S.). (2014). *STEM integration in K-12 education: Status, prospects, and an agenda for research*. Washington, DC: The National Academies Press. Retrieved from [http://www.nap.edu/catalog.php?record\\_id=18612](http://www.nap.edu/catalog.php?record_id=18612)
- National Commission on Excellence in Education. (1983). *A Nation at Risk: The Imperative for Educational Reform* (A Report to the Nation and the Secretary of Education). United States Department of Education.
- National Science and Technology Council Committee on STEM Education. (2013). *Federal Science, Technology, Engineering, And Mathematics (Stem) Education 5-Year Strategic Plan* (p. 127). Retrieved from [https://www.whitehouse.gov/sites/default/files/microsites/ostp/stem\\_stratplan\\_2013.pdf](https://www.whitehouse.gov/sites/default/files/microsites/ostp/stem_stratplan_2013.pdf)
- Neuhauser, C. (2002). Learning style and effectiveness of online and face-to-face instruction. *American Journal of Distance Education*, 16(2), 99–113. [https://doi.org/10.1207/S15389286AJDE1602\\_4](https://doi.org/10.1207/S15389286AJDE1602_4)
- Powell, N. L., & Harmon, B. B. . (2014). Developing Scientists: A Multiyear Research Experience at a Two-Year College. *Journal of College Science Teaching*, 44(2), 11–17.
- Rask, K. (2010). *Attrition in STEM Fields at a Liberal Arts College: The Importance of Grades and Pre-Collegiate Preferences* (Working Paper No. 118). Cornell Higher Education Research Institute. Retrieved from [http://digitalcommons.ilr.cornell.edu/cgi/viewcontent.cgi?article=1141&context=working\\_papers](http://digitalcommons.ilr.cornell.edu/cgi/viewcontent.cgi?article=1141&context=working_papers)
- Rivet, A. E., & Krajcik, J. S. (2008). Contextualizing instruction: Leveraging students' prior knowledge and experiences to foster understanding of middle school science. *Journal of Research in Science Teaching*, 45(1), 79–100. <https://doi.org/10.1002/tea.20203>
- Ross, K., Hooten, M. A., & Cohen, G. (2013). Promoting science literacy through an interdisciplinary approach. *Bioscene: Journal of College Biology Teaching*, 39(1), 21–26.
- Roth, W.-M. (2006). Identity as dialectic: Re/Making self in urban schooling. *Urban Education: An Encyclopedia*. Westport, CT: Greenwood. Retrieved from [http://www.udel.edu/educ/whitson/897s05/files/Roth\\_Identity.pdf](http://www.udel.edu/educ/whitson/897s05/files/Roth_Identity.pdf)
- Rutledge, M. L. ., Bonner, J. W. ., & Lampley, S. A. . (2015). The Impact of active-learning exercises on the grade distribution in a large-lecture, general education biology course. *Journal of College Science Teaching*, 44(5), 16–23.

- Seymour, E., & Hewitt, N. M. (1997). *Talking about leaving: Why undergraduates leave the sciences*. Boulder (Colo.): Westview Press.
- STEMconnector. (2014). *STEM 2.0: An Imperative for Our Future Workforce*. Washington, DC. Retrieved from [www.stemconnector.org](http://www.stemconnector.org)
- Swan, K. (2002). Building learning communities in online courses: The importance of interaction. *Education, Communication & Information*, 2(1), 23–49. <https://doi.org/10.1080/1463631022000005016>
- Tajfel, H. E. (1978). *Differentiation between social groups: Studies in the social psychology of intergroup relations*. Academic Press. Retrieved from <http://psycnet.apa.org/psycinfo/1980-50696-000>
- United States. Congress. Joint Economic Committee Chairman. (2012). *STEM Education: Preparing for the Jobs of the Future*. Washington, DC: 112th Congress. Retrieved from [http://www.jec.senate.gov/public/index.cfm?a=Files.Serve&File\\_id=6aaa7e1f-9586-47be-82e7-326f47658320](http://www.jec.senate.gov/public/index.cfm?a=Files.Serve&File_id=6aaa7e1f-9586-47be-82e7-326f47658320)
- Vilorio, D. (2014). STEM 101: Intro to tomorrow's jobs. *Occupational Outlook Quarterly*, 2–12.
- Vitone, T., Stofer, K. A., Steininger, M. S., Hulcr, J., Dunn, R., & Lucky, A. (2016). School of ants goes to college: Integrating citizen science into the general education classroom increases engagement with science. *Journal of Science Communication*, 15(1), Article A03.
- Wenger, E. (2010). Communities of practice and social learning systems: The career of a concept. In C. Blackmore (Ed.), *Social Learning Systems and Communities of Practice* (pp. 179–198). Springer London. Retrieved from [http://dx.doi.org/10.1007/978-1-84996-133-2\\_11](http://dx.doi.org/10.1007/978-1-84996-133-2_11)
- Wolfe, T. M. (2013). *Investigating Science Identity and Motivation Constructs in Undergraduate Chemistry Through Novel Instrument Development* (Doctoral Dissertation). Oregon State University, Corvallis, OR.

# Planned Behavior Typologies of Agricultural Education Teacher Educators in Regard to Service-Learning as a Method of Instruction: A National, Mixed Methods Study

Richie Roberts, North Carolina A&T State University  
M. Craig Edwards, Oklahoma State University  
Toni A. Ivey, Oklahoma State University

## Abstract

This mixed methods study sought to understand the service-learning (SL) beliefs and intentions of agricultural education teacher educators. Quantitative data were collected using a web-based survey instrument and participant-submitted course syllabi. Next, variables yielding statistically significant relationships were analyzed using cluster analysis. This process produced three unique clusters that were operationalized as typologies through qualitative analysis, which represented the planned behaviors (Ajzen, 1991) of agricultural education teacher educators in regard to SL as a method of instruction: (a) Optimistically Unaware, (b) Policy-focused Decision Makers, and (c) SL Implementers. The Optimistically Unaware expressed positive beliefs about the method, but did not understand how to integrate SL in their teaching methods courses. Meanwhile, the Policy-focused Decision Makers used established education policy standards as anchors when navigating their decision-junctures, such as whether or not to feature SL, in the course design process. SL Implementers, the final typology, espoused strong beliefs about the method's potential while also emphasizing how it could be used to enrich the preparation of agricultural education teachers. Recommendations, implications, and discussion of the results point to the potential SL holds if operationalized as a complement to teacher preparation rather than an addition to current practice.

## Introduction

The emergence of service-learning (SL) in higher education appears to be a relatively recent phenomenon. However, this instructional method has deep philosophical roots that can be traced to some of the earliest origins of formalized learning and education (Speck & Hoppe, 2004), especially in agricultural education (Roberts & Edwards, 2015, 2017). Although thought leaders have championed different instructional methods, curricula, and philosophical positions, their views often converge around the notion that education should be used to foster social harmony and improve society (Fraser, 2014; Tyack, Lowe, & Hansford, 1984). For example, early intellectuals argued that education could be used as a way to improve students' *morals*, *character*, and *virtues* (Rhee, 2012). In a similar way, educators who integrate SL into their courses often seek to advance students' morality, self-concept, and benevolence so they can more intimately understand the world's issues and problems (Crews, 2002; Eyler & Giles, 1999).

Although difficult to define, SL is described as a form of reciprocity in which students extend classroom learning into society to resolve communal problems while also accruing distinct benefits for all participants (Bringle & Hatcher, 1995). During the past two decades, numerous advancements in higher education regarding SL have catalyzed the method's adoption and use (Butin, 2006, 2010; Cipolle, 2010). For example, involvement in *Campus Compact*, a national coalition of postsecondary education institutions with a mission calibrated toward *service*, has soared past 1,100 committed campuses nationwide (Campus Compact, 2016). Yet despite SL's



successes, Saltmarsh and Hartley (2008) suggested the movement had “stagnated and dissipated” (p. 1), especially concerning its ability to bring about “democratic, community-based knowledge and action” (p. 1). To this point, Butin (2006) asserted that many programs were little more than community service efforts in *meaning* and *approach*. Nevertheless, in teacher education, SL has been championed as a way to help preservice teachers gain valuable practical experiences while also making contributions to local education systems and to their surrounding communities (Barnes, 2016; Hildenbrand & Schultz, 2015). In addition, teacher education programs have begun to place increasing emphasis on introducing preservice teachers to instructional methods intended to facilitate higher-order thinking skills, collaborative learning, as well as the ability to address ambiguous and complex social problems (Yang, Chang, & Hsu, 2008). Because SL as a method of instruction is positioned to assist in achieving such outcomes, it has received growing attention in teacher preparation programs (Ball & Geleta, 2012; Chambers & Lavery, 2012; Hart & King, 2007). Nonetheless, many instructors struggle with the ambiguities inherent in SL and choose to embrace more teacher-centric approaches in practice (Yang et al., 2008).

As a result, proponents interested in using SL in teacher education have begun to consider integrating the method into teacher preparation by exploring teacher educators’ *beliefs* and *intentions* (Ball & Geleta, 2012; Bates, 2009; Hou, 2010; Tatebe, 2013). Proponents of this integration assert SL is a way to instill professional and ethical core values (Anderson, 2000), to foster enhanced student meaning-making when solving complex problems (Lake & Jones, 2008), and to improve teachers’ efficacy for working with diverse populations (Daniels, Patterson, & Dunston, 2010). However, Hildenbrand and Schultz (2015) expressed concerns regarding the lack of evidence to support the claim that SL should be *used* and *highlighted* as a method of instruction in teacher preparation programs. Examples of obstacles to SL’s widespread adoption in teacher education include difficulties with attaining service sites, addressing challenges to upholding state and national teacher education standards, and juggling an already robust curriculum (Anderson & Pickeral, 1998) in many cases. Attempts to understand teacher educators’ beliefs and intentions regarding the use of SL in agricultural education appear to have received scant attention from researchers. Therefore, this question lingers: *Do agricultural education teacher educators’ beliefs and intentions support the use of SL as a method of instruction?*

Roberts and Edwards (2015, 2017) touched on this issue by calling for a sharper focus on SL in agricultural education teacher preparation programs. Nevertheless, little attention appears to have been devoted to addressing this issue. More research is needed to distill the beliefs and intentions that presage, inspire, and embolden teacher educators to use SL as an instructional method in their teacher preparation courses (a) to facilitate the learning of preservice students and (b) with the intention of students acquiring SL as a teaching method to use as in-service teachers. This insight may yield important new understandings of the behaviors influencing how SL is conceptualized and practiced in school-based, agricultural education (SBAE).

### **Theoretical Framework**

This study was grounded in Ajzen’s (1991) theory of planned behavior (TPB). Through this lens, an individual’s *behavior* is shaped by his or her underlying *intentions* (Ajzen, 2006). However, Ajzen (1991) theorized that three systems of *belief* foreground an individual’s intentions: (a)

behavioral (attitudes), (b) normative (subjective or social norms), and (c) control (perceived behavior controls). *Behavioral beliefs*, or *attitudes*, refer to the perceptions individuals’ hold regarding the consequences of particular behaviors; therefore, perceptions can influence the formation of positive or negative attitudes (Ajzen, 2006). If their attitudes toward given behaviors are favorable, individuals are more likely to engage in such, and the counterfactual is also more likely. On the other hand, *normative beliefs*, or *subjective norms*, represent the degree of *social pressure* individuals recognize, which influence their adoption or rejection of behaviors (Ajzen, 2002). Finally, *control beliefs*, or *perceived behavioral controls*, are related to the levels of difficulties individuals perceive associated with implementing or exercising behaviors. The manipulation of one or more of these belief systems is theorized to influence whether individuals intend to execute specific behaviors in the future (Francis et al., 2004). Figure 1 provides a visual representation of Ajzen’s (1991) theory of planned behavior.

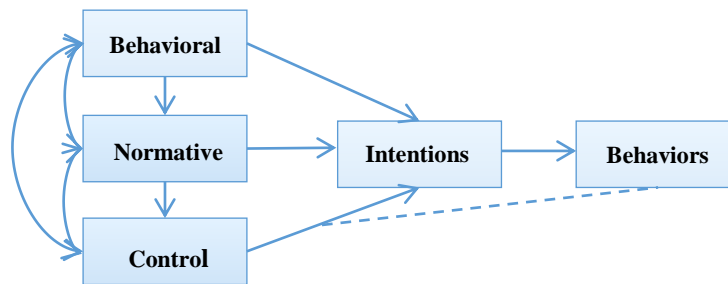

Figure 1. The theory of planned behavior. Adapted from “The Theory of Planned Behavior” by I. Ajzen, 1991, *Organizational Behavior and Human Decision Processes*, 50, p. 182. Copyright 1991 by Academic Press, Inc.

In this study, behavioral beliefs were conceptualized as the perceived benefits to the classroom and community, normative beliefs as perceived barriers within the institution, and control beliefs as the participants’ perceived barriers to using SL in their classrooms. In addition, the intentions of agricultural education teacher educators were interpreted by the degree to which instructors integrated SL into their course syllabi. Therefore, this investigation sought to describe participants’ beliefs and intentions about SL as a method of instruction.

### Purpose

A mixed methods study sought to understand the SL beliefs and intentions of agricultural education teacher educators. As such, it was positioned to address Priority 6 of the American Association for Agricultural Education’s (AAAE) National Research Agenda by focusing on effective delivery methods to build “vibrant, resilient communities” (Graham, Arnold, & Jayaratne, 2016, p. 49). By using Ajzen’s (1991) TPB as a theoretical lens, one research question guided the portion of a larger investigation reported on here: *How did the study’s qualitative findings help explain quantitative patterns?*

### Methodology and Procedures

This study used an explanatory, sequential mixed methods design by which priority was assigned to the qualitative strand, i.e., Quan → QUAL (Creswell & Plano Clark, 2011). Relying on a pragmatist lens (Morgan, 2007), the first phase was comprised of quantitative data collection

employing Dillman's, Smyth's, and Christian's (2014) tailored survey design procedures to collect data through a web-based instrument using Qualtrics™ online software. The participants also submitted course syllabi, which were quantized during analysis using the *SL Syllabus Analysis Guide* [SLSAG] (Gelmon, Holland, Driscoll, Spring, & Kerrigan, 2001). Cluster analysis procedures were followed (Macia, 2015) to identify patterns resulting from the quantitative findings. Cluster analysis allows researchers to categorize individuals using a combination of relevant variables. The combination of variables used for clustering was determined by mobilizing those yielding statistically significant relationships ( $p < .05$ ) with the dependent variables (Mooi & Sarstedt, 2011). Thereafter, qualitative data were collected from nine agricultural education teacher educators, as determined by cluster analysis, to develop typologies – a procedure evoking rich meaning from the members of each cluster.

### **Role of the Researchers**

Our engagement with the data changed based on the phase of the study. As such, it is important to reveal our previous experience and biases. For instance, each researcher served as a SBAE instructor in their respective home states. Further, the lead researcher had used SL to improve student learning outcomes and the method serves as his primary line of inquiry. It also bears noting that we had interacted with participants in this study at research conferences and other professional venues. Therefore, these interactions could have influenced some individuals to participate in the study as well as what they chose to share in their responses. Finally, gift card incentives were used to recruit participants for the study.

### **Phase I: Participant Recruitment, Quantitative Data Collection, & Instrumentation**

The population was a census of agricultural education teacher educators who were active members of the American Association for Agricultural Education (AAAE). As such, the frame for this study was AAAE's membership directory maintained by its Membership Secretary (AAAE, 2016). However, instructors could teach methods courses that include aspects of SL who were not members of AAAE, i.e., the possibility of coverage error existed (Dillman et al., 2014). More than 80 higher educational institutions in the United States prepare SBAE instructors (Birkenholz & Simonsen, 2011). To ensure the population of interest was identified, we administered a web-based instrument packet (Dillman et al., 2014) through the AAAE electronic mail listserv. The participants were asked to indicate whether they taught at least one agricultural education teaching methods course either during the three previous academic years or would do such in the spring academic term of 2017. This criterion was used as a sorting variable to determine the eligibility of participants who should complete the survey instrument. Individuals who met the criterion were allowed to continue to the remainder of the instrument's items and submit a course syllabus; other respondents were not permitted to continue. In total, 77 agricultural education teacher educators responded to the online survey instrument, resulting in 46 useable responses (59%) with 43 institutions represented.

The web-based instrument had three measures: (a) personal characteristics, (b) items slightly modified from Hou's (2010) Web-based Faculty Service-Learning Beliefs Inventory (wFSLBI), and (c) items slightly modified from the SLSAG (Gelmon et al., 2001). Reported findings are part of a larger data set. Results from quantitative measures *are not featured here* but were used

to demonstrate the quantitative strand's role in the development of typologies. The primary quantitative measure, the wFSLBI, was designed to understand faculty members' SL beliefs and is theoretically grounded in Ajzen's (1991) TPB. Through factor analysis procedures, Hou (2010) confirmed four distinct factors: (1) perceived benefits at the classroom level (PROS\_CLS) with seven items, (2) perceived benefits at the community level (PROS\_COM) with six items, (3) perceived barriers at the classroom level (CONS\_CLS) with four items, and (4) perceived barriers at the institutional level (CONS\_INST) with three items (Hou, 2010). Post-hoc reliability estimates for each of the instrument's four subscales were .71 or larger and considered acceptable (Field, 2013). We also used the SLSAG (Gelmon et al., 2001) to analyze the agricultural education teacher educators' *intentions* in regard to SL as evinced in their course syllabi. We provided a training session for the raters to establish interrater reliability in which two external raters and the lead researcher scored participants' syllabi (Bornmann, Mutz, & Daniel, 2010). Interrater reliability analysis yielded an interclass correlation coefficient (ICC) of .88 which was considered satisfactory (Whitehurst, 1984).

### **Inter-Phase: Clustering Procedures and the Identification of Qualitative Cases**

In this study, we analyzed quantitative variables that yielded statistically significant relationships through cluster analysis procedures (Macia, 2015). Thereafter, a two-step cluster analysis approach was used rather than hierarchical or k-means because the variables of interest were a combination of ordinal and nominal data derived from different scales (Chiu, Fang, Chen, Wang, & Jeris, 2001). Each variable, therefore, was standardized before initiating clustering procedures. In the first stage, homogenous clusters were formed based on their rank (Chiu et al., 2001). After the first iteration, eight clusters were generated. Then, clusters were discriminated, and reduced, based on predictor importance (Mooi & Sarstedt, 2011). Through this technique, *three high-quality clusters* were identified. Across clusters, predictor importance included participants' (a) SL experiences in postsecondary education, (b) SL teaching experiences, (c) intentions, (d) SL experiences in secondary education, as well as (e) their perceptions of SL regarding CONS CLS, PROS CLS, CONS INST, and PROS COMM. The three clusters were then operationalized as bounded cases (Stake, 2006) for qualitative analysis.

### **Phase II: Qualitative Data Collection, Analysis, and Typology Development**

In the qualitative phase, we used a multiple case study approach (Stake, 2006) to *develop* and *define* typologies. Emphasis in the qualitative strand was placed on gaining *representativeness* (Teddlie & Yu, 2007). Therefore, we selected three qualitative cases from each cluster using random selection – an approach that is *rare but acceptable in qualitative inquiry* (Miles, Huberman, & Saldaña, 2014). For example, we randomly selected participants 41, 44, and 46 in the first cluster, participants 9, 20, and 39 in the second cluster, and participants 13, 24, and 26 in the third cluster. As such, nine participants participated in 45 to 60 minute semi-structured telephone or Skype® interview sessions (Creswell & Plano Clark, 2011). Thereafter, each qualitative interview was transcribed verbatim. Next, qualitative analysis software NVivo® was used to manage and explore the data. Initial data analysis was conducted using the constant comparative method, which was facilitated through three coding types: (a) open, (b) axial, and (c) selective (Corbin & Strauss, 2015). Open coding required us to label data units into distinct categories. Thereafter, axial coding necessitated that we scrutinize relationships among

categories to develop evidentiary warrants (Saldaña, 2012). We then used selective coding to create an analytic storyline of the data. As a result, our assertions for typology generation were *built up* to narrate the multiple views presented in each cluster (Corbin & Strauss, 2015). Through case comparisons and contrasts, we then chose to operationalize the clusters as typologies by weaving the voices of *within case* participants into rich descriptions (Stake, 2006). It should be noted that Lincoln's and Guba's (1985) four criteria for qualitative quality – credibility, confirmability, transferability, and dependability – drove our ethical decision making. To achieve this, we triangulated findings through multiple forms of data (credibility); were explicit about our decisions, biases, and other influences (confirmability); sought a theoretically diverse sample (transferability); and strove to conduct an investigation that was stable and consistent with the traditions of qualitative inquiry (dependability) [Lincoln & Guba, 1985].

## Findings

The three typologies identified through cluster analysis procedures represent the planned behaviors (Ajzen, 1991) of agricultural education teacher educators in regard to SL as a method of instruction: (a) *Optimistically Unaware*, (b) *Policy-focused Decision Makers*, and (c) *SL Implementers*. It is important to note that no typology is considered better or more correct in regard to conceptualizing or delivering teaching methods courses in agricultural education. A description of each typology is offered next along with supporting themes, which are grounded in Ajzen's (1991) three belief systems: (a) behavioral, (b) normative, and (c) control.

### Typology #1: *Optimistically Unaware*

The *Optimistically Unaware* participants expressed positive beliefs about the potential of SL. In addition, each of the three participants interviewed were familiar with the term *service-learning* and two had experience with the method at the secondary school level. However, the *Optimistically Unaware* explained they did not fully understand how to integrate or feature the method in their teaching methods courses within existing design structures. Therefore, given the background of the *Optimistically Unaware* their beliefs and intentions were presented through a lens of *projection*, i.e., largely experience and context free.

### Behavioral Beliefs

Two sub-themes explained the *Optimistically Unaware*'s behavioral *beliefs* (Ajzen, 1991): (a) experiential learning, and (b) SL's benefit to SBAE's comprehensive, three-circle model.

**Experiential Learning.** Each participant belonging to the *Optimistically Unaware* typology articulated that they saw value in SL because of its experiential nature. They explained that teaching experientially could help *bring the curriculum to life* by making learning more permeable in which the *walls* separating classrooms and the real-world could be diminished. Participant 44 explained: "Hands on anything is always a positive. And I think that service-learning has potential to actually put them [students] in those real-world situations."

**SL's Benefits to SBAE's Comprehensive, Three-Circle Model.** Although the *Optimistically Unaware* did not appear to have put much deep philosophical thinking into using

SL as a method of instruction, they were able to articulate ways the method might benefit each component of SBAE's comprehensive, three-circle model. For example, describing SL's role in SBAE, Participant 41 highlighted the ways in which SBAE teachers were using SL through classroom activities in her home state. She elaborated: "Yesterday afternoon [I visited] a meat laboratory, the hams and bacon that [did not] get bought [were] donated to the local food bank."

### **Normative Beliefs**

Receiving support from individuals of influence is critical to forming intentions of planned behavior – a concept Ajzen (1991) called normative beliefs. Therefore, in this study, normative beliefs refer to whether participants perceived their institutions' leaders encouraged the use of SL. Overall, participants reported a *supportive institutional culture* in regard to SL. Participant 48 even suggested that his institution might look favorably on using SL in the tenure and promotion process: "In the teaching portion of our P&T packet, there is a place where it asks not just for like your normal coursework or anything like that, [but also] other teaching experiences and I think you could highlight service-learning."

### **Control Beliefs**

How individuals view the perceived challenges of an endeavor is critical in the formation of control beliefs (Ajzen, 1991). As such, participants in this study considered their personal challenges as well those that preservice teachers might face in regard to implementing the method. To this point, the *Optimistically Unaware's* control beliefs emerged through two subthemes: (a) lack of understanding and (b) time.

**Lack of Understanding.** The most consistently reported barrier from the *Optimistically Unaware* typology was the *lack of understanding of SL*. For example, the participants perceived neither they nor others in agricultural education fully understood the difference between SL and community service. And, as a consequence, opportunities for using SL were not fully realized. Participant 41 explained: "I think there's something going on [with SL but] they [SBAE teachers] just don't know what it is."

**Time.** Acknowledging the challenge of overwhelming *time commitments* when conducting quality SL projects also arose as a core *control belief*. Participant 44 elaborated: "I think the time; time is definitely a barrier to doing these type[s] of service-learning things." Although the *Optimistically Unaware* participants recognized the advantages of SL, their lack of understanding and perceptions of time constraints seemed to inhibit their adoption of the method. Nevertheless, they were optimistic about SL's potential as a method of instruction in SBAE.

### **Typology #2: Policy-focused Decision Makers**

The second typology was comprised of individuals with SL experience as students and teachers. However, their intentions concerning the use of SL varied considerably. Through analysis of these discrepancies, the second planned behavior typology emerged as *Policy-focused Decision Makers* because, although their experiences, beliefs, and intentions often supported the use of

SL, perceptions of existing educational policies determined the degree to which they incorporated the method in their teacher preparation courses.

## **Behavioral Beliefs**

The *Policy-focused Decision Makers* expressed largely positive and encouraging views concerning the benefits of SL as a method of instruction. Existing attitudes within this typology, therefore, supported the use of SL – a notion connected to Ajzen’s (1991) behavioral beliefs. Two distinct subthemes emerged uniformly through data analysis: (a) SL’s benefits to SBAE’s comprehensive, three-circle model and (b) the personal development of students.

**SL’s Benefits to SBAE’s Comprehensive, Three-Circle Model.** When articulating the advantages that SL may offer agricultural education, the *Policy-focused Decision Makers* noted the method could assist instructors with delivering SBAE’s comprehensive, three-circle model. In support, Participant 39 described how his ideal three-circle model would include a SL component. He opined: “Ideally if you had [a] paintbrush, [being] the paint guy, you want a program that’s going to be meant for service-learning with all three circles being equal.”

**Personal Development of Students.** Each of the *Policy-focused Decision Makers’* interviews mentioned the transformative potential that SL could offer students. Participant 9 explained how SL might be used to help students adopt a more accepting and change-focused worldview. She elaborated: “[I]t’s so critical that students think past our own very small individual universe and think about that whole idea of tithing, in the big sense not religious, but giving back.” Therefore, they appeared to perceive the method could help their students grow in deeply personal ways.

## **Normative Beliefs**

Ajzen (1991) referred to normative beliefs as views influenced by individuals and forces deemed important within a given social system. For the *Policy-focused Decision Makers*, these beliefs surfaced as conflicted yet distinguishing features. Two subthemes provided the basis for this interpretation: (a) policies as decision anchors and (b) supportive institutional cultures.

**Policies as Decision Anchors.** Although *Policy-focused Decision Makers* expressed positive views about SL, their intentions were diverse in regard to integrating the method into their teaching methods courses. After reflecting on the participants’ perspectives, the belief that *policy served as their decision anchors* emerged. For example, when conceptualizing courses, individuals comprising this typology appeared to consult existing policies to decide which teaching methods, assignments, and projects held the most value for their students. In the case of Participant 20, she explained that “[e]verything goes through the teacher education committee. They’re a governing body of the education division. I have the freedom to do some things, but something that affects the portfolio of those students, I don’t have that authority.”

**Supportive Institutional Culture.** Participants 9, 20, and 39 articulated that their campuses largely promoted a *culture* in which SL was encouraged. For example, all reported having an Office of SL, institutional missions that addressed the need for the method, as well as

the provision of SL-related professional development opportunities on their campuses. Participant 39 elaborated: “My university requires each college to have SL in their classes. In our university catalog, some courses are designated as a SL course.”

### **Control Beliefs**

Control beliefs, or how easy or difficult a behavior may be to implement, of *Policy-focused Decision Makers* related to the issue of time. Participant 20 contended: “The biggest thing is time.” The teacher educators explained that SBAE instructors in their home states had many job duties and, therefore, little temporal space existed in which to implement what they perceived to be a time-consuming method of instruction. The *Policy-focused Decision Makers* had significant experience with SL as a method of instruction, however, existing educational policies appeared to shape the degree to which they chose to integrate SL in their teaching methods courses.

### **Typology #3: SL Implementers**

Members of the third cluster, *SL Implementers*, espoused strong beliefs about the method’s potential while also emphasizing how it could be used to enrich agricultural education teacher preparation. The *SL Implementers* articulated their beliefs and intentions (Ajzen, 1991) in regard to SL by drawing on prior related teaching experiences rather than projecting what the method of instruction *might* achieve. *SL Implementers* had experiences with the method as students and teachers and voiced intentions to continue to use the method in their future practice.

### **Behavioral Beliefs**

Emerging from the data corpus were *SL Implementers’* richly storied and temporally marked illustrations of their behavioral beliefs: (a) SL as a complement to teacher education, (b) SL’s role in SBAE’s comprehensive, three-circle model, and (c) the personal development of students.

**SL as a Complement to Teacher Education.** The *talk* of *SL Implementers* in regard to the method illuminated how they used it in teacher preparation to *uphold* and *operationalize* their philosophies of teaching. For example, they revealed that using the method emboldened them to challenge their students to grapple with the complexities of teaching and learning outside the walls of university classrooms while negotiating such experiences through reflection. Participant 13 explained: “It starts to give them [my students] a halfway real perspective of what it looks like to be a teacher in a classroom.”

**SL’s Benefits to SBAE’s Comprehensive, Three-Circle Model.** The *SL Implementers* also elucidated the *strategic advantages* that using SL could provide teachers in regard to delivering SBAE’s comprehensive, three-circle model. For example, patterns of discourse converged on the notion that SL could assist in facilitating learning experiences within and among the FFA, SAE, and classroom and laboratory aspects of SBAE. When considering SL’s potential, Participant 24 explained: “I think service-learning plays a part in all” three dimensions of an agricultural education program. However, they also noted that challenges still had to be overcome before its use became more widely adopted in all three components of the model.



**Personal Development of Students.** By design, SL is employed to assist students with *making sense* of experiences while also forging deep connections regarding how their actions can create change in local communities. Participant 26 described how the method could enhance students' personal development. He explained that by partaking in acts of service, students begin to embrace a sense of "leadership" and "responsibility" which helped them adopt more mature perspectives. He maintained this maturation was visible when interacting with individuals in the community. He further said: "By helping within the community you [, i.e., his students,] start to be looked upon as a leader and someone to go to."

## Normative Beliefs

Faculty members are often influenced in their roles by *institutional controls* (Lawrence, 2008) that govern existing practices, policies, and day-to-day activities. Two sub-themes undergird the normative beliefs theme: (a) supportive institutional cultures and (b) professional enrichment.

**Supportive Institutional Cultures.** Each participant interviewed from the third cluster emphasized the highly supportive culture for SL at his or her respective institution. Participant 26 stated: "We have a whole office of service-learning. We were one of the first institutions in the country to require each department to have a certain number of hours of service-learning." Other examples of assistive institutional cultures included offices of SL on the participants' campuses, award recognitions, professional development opportunities, SL-designated course offerings, and student course credit hours for their SL endeavors.

**Professional Enrichment.** The *SL Implementers* interviewed also described the scholarly enrichment the method offered to their careers. For example, the participants had used the method to support their scholarly interests, while also benefitting students and local communities. Participant 13 explained: "I did just a brief poster presentation last year based on some data we collected on a couple semesters in terms of our [SL] project."

## Control Beliefs

The third theme captured *SL Implementers'* beliefs and experiences navigating the perceived challenges of SL – a concept Ajzen (1991) termed *control beliefs*. The *SL Implementers* were candid about the method's downsides and collectively expressed the view that SBAE teachers must be fully committed to ensure their SL projects are successful. The major challenge stressed by the *SL Implementers* was the concept of time. Participant 26 gave voice to this issue: "for them to have extra time to go devote two or three days for a [service-learning] project is sometimes quite difficult." The *SL Implementers* advocated for SL in their teacher preparation programs based on previous experiences supporting beliefs that it could be used to complement teacher education by helping to build preservice teachers' capacities to implement the method in their future practice.

## Conclusions

The intent of this investigation was to understand the SL beliefs and intentions of agricultural education teacher educators. Findings suggested that the planned behaviors (Ajzen, 1991) of

agricultural education teacher educators regarding their use of SL as a method of instruction can be interpreted through three typologies. For example, the *Optimistically Unaware* explained they did not understand how to implement SL into their courses. Meanwhile, *Policy-focused Decision Makers*' beliefs systems often supported the use of SL, however, existing educational policies influenced their decisions on whether to use SL. The final typology, *SL Implementers*, articulated how they used SL as a *complement* to teacher preparation. These views offered new insights on the TPB (Ajzen, 1991) as well as the practice of SL, especially concerning the method's existing position in programs for the preparation of agricultural education teachers. Findings, therefore, not only broaden the SL and agricultural education literature bases but also introduce new developments for the relevance of Ajzen's (1991) TPB toward understanding the pedagogical choices of teacher educators.

A cross-case analysis (Stake, 2006) of the study's qualitative themes revealed similarities and differences in regard to the dimensions of participants' three belief systems, as theorized by Ajzen (1991). Differences among the study's emergent factors helped define and describe each typology distilled by the researchers. Moreover, it is critical to acknowledge that across typologies, three subthemes were constant: (a) SL's benefits to SBAE's comprehensive, three-circle model, (b) supportive institutional cultures, and (c) time. For instance, representatives from each typology spoke to SL's potential to serve as a delivery strategy in all three programmatic dimensions of SBAE: (a) classroom and laboratory instruction, (b) SAE, and (c) the FFA. For the teacher educators in this study, however, their articulation of examples and strategies for SBAE instructors to use in facilitating SL in students' SAEs was mostly tacit if not ambiguous – a finding not currently reflected in the agricultural education literature. In each typology, participants reported relatively supportive institutional cultures for SL. In this regard, the participants reported their institutions maintained offices of SL, provided professional development opportunities, offered faculty awards, and, in some cases, required colleges and departments to designate SL courses. Further, the teacher educators perceived their administrators were supportive of the method's use in teacher preparation for agricultural education. These findings align with existing SL literature (Barnes, 2016; Butcher et al., 2003; Hart & King, 2007), but had not been previously reported in agricultural education.

When asked to articulate the potential challenges of integrating SL into their courses, the participants identified *time* as a consistent barrier. The time factor was perceived as a challenge because the agricultural education teacher educators described struggling to find enough space in their courses to properly integrate and feature the method. The participants also noted that time was a barrier for SBAE instructors due to the many duties, responsibilities, and expectations associated with their jobs, which already monopolized their schedules. Although time is a common barrier reported in the SL literature (Butin, 2006; Chambers & Lavery, 2012), it may not have received sufficient attention in preparing teachers of agricultural education to use SL.

### **Recommendations, Implications, and Discussion**

The development of planned behavior typologies in this investigation appear to unsettle and expand existing conceptions of SL in the context of agricultural education. Given these new insights, it is important to address the resulting implications for research, theory, and practice.

First, future researchers should explore how teacher educators' behavioral, normative, and control beliefs (Ajzen, 1991) influence the ways they depict SL's ability to integrate the primary dimensions of SBAE's comprehensive, three-circle model (Croom, 2008; Roberts & Edwards, 2015). Because of the rich discourse surrounding SL, as articulated by participants in this study, more research is needed to explain how successful SL SAE's are defined and operationalized. In addition, given the emergence of the *Policy-focused Decision-Makers* typology, researchers should also consider the ways and extent that existing educational policies might stifle the use of SL in teacher preparation courses. Because some teacher educators in this study reported they did not feature or use SL as a method of instruction, future studies should also investigate the implications of silencing SL in the teacher education curriculum, and that may negate potential outcomes for student learning and the transformation of SBAE programs and local communities. More research is also needed to uncover the stories that *SL Implementers* tell about the impacts of SL on students and communities associated with using the method. In addition, future investigations should seek to identify which *lived experiences* involving SL influence teacher educators' decisions to integrate the method into their teacher preparation courses.

Ajzen's (1991) TPB is often used as a theoretical grounding in quantitative-oriented studies (Armitage & Conner, 2001; Chiaburu & Tekleab, 2005; McCarthy & Garavan, 2006). However, this study offered new understandings into the ways the theory could be expanded, i.e., the development of planned behavior typologies. As such, more theory-building efforts should be devoted to understanding the limits and possibilities of Ajzen's (1991) TPB, especially in regard to SL in agricultural education. For example, by securing a theoretical sample (Miles et al., 2014), grounded theory methods could be used to more intimately describe the influences, processes, and parameters that foreground the planned behaviors of teacher educators.

This study also holds important implications for future practice. To this aim, agricultural education teacher educators should utilize the resources available at their home institutions to support them in considering how SL could be integrated in their teaching methods courses. Perhaps these local professionals can provide valuable institutional knowledge and assets that would assist teacher educators in traversing the various educational policies and scheduling issues appearing to influence their underlying intentions about using SL as a method of instruction. In addition to using local resources, professional development opportunities also should be incorporated at American Association for Agricultural Education (AAAE) conferences – regional and national – to demonstrate how SL can be used in teaching methods courses. During these professional development opportunities, dialogue could occur among agricultural education teacher educators regarding the teaching methods that best prepare preservice teachers to deliver SBAE's comprehensive, three-circle model in more integrated and complementary ways (Roberts & Edwards, 2015). Such discussions should also involve SL's place and relevance in the delivery of SBAE programs by agricultural education teachers.

Although agricultural education teacher educators appear to understand the benefits of SL as a method of instruction, more work is needed to assist them with learning to navigate the challenges inherent to its use. To that aim, professional development sessions should specifically address issues such as *lack of knowledge* of SL and *time constraints*, as perceived to be associated with implementing the method. Example course syllabi also should be shared with AAAE members that demonstrate how to integrate SL as a method of instruction in teaching

methods courses. Perhaps by considering high-quality examples of how the method is being used to enrich teacher preparation, agricultural education teacher educators would begin to make shifts in their practice. Further, agricultural education teacher educators should be encouraged to reconsider the view that SL will require *additional time* in their methods courses. Instead, they should be urged to consider SL as a *complement* to their teacher preparation programs. For example, perhaps a service-based learning project serves as a *capstone experience* in teaching methods courses by which a majority of the assignments, such as lesson plan development and use, are connected to a larger SL undertaking in their institutions' surrounding communities. Finally, agricultural education teacher educators should be encouraged to model the use of SL so their preservice students' opportunities increase to observe and experience the method, including the creation of awareness, how-to, and principles knowledge (Rogers, 2003). Implementing these approaches could create space for discussing the challenges SBAE instructors may encounter when using SL in their teaching practice and how to overcome such.

### References

- Ajzen, I. (1991). The theory of planned behavior. *Organizational Behavior and Human Decisions Processes*, 50(1), 179-211. doi:10.1016/0749-5978(91)90020-T
- Ajzen, I. (2002). *Constructing a TpB questionnaire: Conceptual and methodological considerations*. Amherst: University of Massachusetts System. Retrieved from <http://www.people.umass.edu/aizen/pdf/TpB.measurement.pdf>
- Ajzen, I. (2006). *Behavioral interventions based on the theory of planned behavior*. Amherst: University of Massachusetts System. Retrieved from <http://www.people.umass.edu/aizen/pdf/tpb.intervention.pdf>
- American Association for Agricultural Education. (2016). *Membership information*. Author. Retrieved from <http://www.aaaeonline.org/join>
- Anderson, J. B. (2000). *Learning in deed: Service-learning and preservice teacher education*. Denver, CO: Education Commission of the States.
- Anderson, J. B., & Pickeral, T. (1998). *Challenges and strategies for success with service-learning in preservice teacher education*. Omaha: University of Nebraska.
- Armitage, C. J., & Conner, M. (2001). Efficacy of the theory of planned behavior: A meta-analytic review. *British Journal of Social Psychology*, 40(4), 471-499. doi: 10.1348/014466601164939
- Ball, D., & Geleta, N. (2012). A delicate balance: Service-learning in teacher education. *Journal of the Scholarship of Teaching and Learning*, 5(1), 1-17. Retrieved from <http://files.eric.ed.gov/fulltext/EJ910337.pdf>
- Barnes, M. E. (2016). The student as teacher educator in service-learning. *Journal of Experiential Education*, 39(4), 238-253. doi:10.1177/1053825916643831

- Bates, A. J. (2009). Service learning as an instructional strategy for the preparation of teachers. *Journal of Effective Teaching*, 9(1), 5-23. Retrieved from <http://files.eric.ed.gov/fulltext/EJ1092201.pdf>
- Birkenholz, R. J., & Simonsen, J. C. (2011). Characteristics of distinguished programs of agricultural education. *Journal of Agricultural Education*, 52(3), 16-26. doi: 10.5032/jae.2011.03016
- Bornmann, L., Mutz, R., & Daniel, H. D. (2010). A reliability-generalization study of journal peer reviews: A multilevel meta-analysis of inter-rater reliability and its determinants. *PLoS ONE*, 5(12), 1-10. doi:10.1371/journal.pone.0014331
- Bringle, R. G., & Hatcher, J. A. (1995). A service-learning curriculum for faculty. *Michigan Journal of Community Service Learning*, 2(1), 112-122. Retrieved from <http://hdl.handle.net/2027/spo.3239521.0002.111>
- Butcher, J., Howard, P., Labone, E., Bailey, M., Groundwater, S., McFadden, . . . & Martinez, K. (2003). Teacher education, community service learning, and student efficacy for community engagement. *Asia-Pacific Journal of Teacher Education*, 31(1), 109-124. doi:10.1080/13598660301612
- Butin, D. W. (2006). The limits of service-learning in higher education. *The Review of Higher Education*, 29(4), 473-498. doi:10.1353/rhe.2006.0025
- Butin, D. W. (2010). *Service-learning in theory and practice: The future of community engagement in higher education*. New York, NY: Palgrave.
- Campus Compact. (2016). *Presidents' declaration on the civic responsibility of higher education*. Author. Retrieved from <http://www.compact.org/presidential/declaration.html>
- Chambers, D. J., & Lavery, S. (2012). Service-learning: A valuable component of pre-service teacher education. *Australian Journal of Teacher Education*, 37(4), 99-108. Retrieved from <http://search.informit.com.au/documentSummary;dn= 767781396834335;res=IELAPA>
- Chiaburu, D. S., & Tekleab, A. G. (2005). Individual and contextual influences on multiple dimensions of training effectiveness. *Journal of European Industrial Training*, 29(8), 604-626. doi:10.1108/03090590510627085
- Chiu, T., Fang, D., Chen, J., Wang, Y., & Jeris, C. (2001). A robust and scalable clustering algorithm for mixed type attributes in a large database environment. *Proceedings of the 7th International Conference on Knowledge Discovery and Data Mining* (pp. 263-268), San Francisco, CA.

- Cipolle, S. B. (2010). *Service-learning and social justice: Engaging students in social change*. Lanham, MD: Rowman & Littlefield Publishers.
- Corbin, J., & Strauss, A. (2015). *Basics of qualitative research: Techniques and procedures for developing grounded theory* (4th ed.). Thousand Oaks, CA: Sage.
- Creswell, J. W., & Plano Clark, V. L. (2011). *Designing and conducting mixed methods research* (2nd ed.). Thousand Oaks, CA: Sage.
- Crews, R. J. (2002). *Higher education service-learning: Sourcebook*. Westport, CT: Oryx Press.
- Croom, D. B. (2008). Development of the integrated three-component model of agricultural education. *Journal of Agricultural Education*, 49(1), 110-120.  
doi:10.5032/jae.2008.01110
- Daniels, K., Patterson, G., & Dunston, Y. (2010). Rules of engagement: A service learning pedagogy for preservice teacher education. *Journal for Civic Commitment*, 15(1), 1-16.  
Retrieved from [http://ccnce.org/wp-content/uploads/2014/06/15\\_Daniels.pdf](http://ccnce.org/wp-content/uploads/2014/06/15_Daniels.pdf)
- Dillman, D. A., Smyth, J. D., & Christian, L. M. (2014). *Internet, phone, mail, and mixed-mode surveys: The tailored design method* (4th ed.). Hoboken, NJ: John Wiley & Sons.
- Eyler, J., & Giles, D. E. (1999). *Where's the learning in service-learning?* San Francisco, CA: Jossey-Bass.
- Gelmon, S. B., Holland, B. A., Driscoll, A., Spring, A., & Kerrigan, S. (2001). *Assessing service learning and civic engagement: Principles and techniques*. Providence, RI: Campus Compact.
- Graham, D. L., Arnold, S., & Jayaratne, K. S. U. (2016). Research priority 6: Vibrant, resilient communities. In T. G. Roberts, A. Harder, & M. T. Brashears (Eds.), *American Association for Agricultural Education national research agenda: 2016-2020* (pp. 49-56). Gainesville, FL: Department of Agricultural Education and Communication, University of Florida.
- Hart, S. M., & King, J. R. (2007). Service learning and literacy tutoring: Academic impact on pre-service teachers. *Teaching and Teacher Education*, 23(4), 323-338.  
doi:10.1016/j.tate.2006.12.004
- Hildenbrand, S. M., & Schultz, S. M. (2015). Implementing service learning in pre-service teacher coursework. *Journal of Experiential Education*, 38(3), 262-279. doi: 10.1177/1053825915571748
- Hou, S. I. (2010). Developing a faculty inventory measuring perceived service-learning benefits and barriers. *Michigan Journal of Community Service Learning*, 16(2), 78-89. Retrieved from <http://hdl.handle.net/2027/spo.3239521.0016.206>

- Field, A. (2013). *Discovering statistics using IBM SPSS statistics* (4th ed.). Thousand Oaks, CA: Sage.
- Francis, J. J., Eccles, M. P., Johnston, M., Walker, A., Grimshaw, J., & Foy, R. (2004). *Constructing questionnaires based on the theory of planned behavior: A manual for health services researchers*. Newcastle, UK: Centre for Health Services Research. Retrieved from <http://openaccess.city.ac.uk/1735/>
- Fraser, J. W. (2014). *The school in the United States: A documentary history* (3rd ed.). New York, NY: Routledge.
- Lake, V. E., & Jones, I. (2008). Service-learning in early childhood teacher education: Using service to put meaning back into learning. *Teaching and Teacher Education*, 24(8), 2146-2156. doi:10.1016/j.tate.2008.05.003
- Lincoln, Y. S., & Guba, E. G. (1985). *Naturalistic inquiry*. Newbury Park, CA: Sage.
- Macia, L. (2015). Using clustering as a tool: Mixed methods in qualitative data analysis. *The Qualitative Report*, 20(7), 1083-1094. Retrieved from <http://www.nova.edu/ssss/QR/QR20/7/maciaz3.pdf>
- McCarthy, A., & Garavan, T. (2006). Postfeedback development perceptions: Applying the theory of planned behavior. *Human Resource Development Quarterly*, 17(3), 245-267. doi:10.1002/hrdq.1173
- Miles, M. B., Huberman, A. M., & Saldaña, J. (2014). *Qualitative data analysis* (3rd ed.). Thousand Oaks, CA: Sage.
- Mooi, E., & Sarstedt, M. (2010). *Cluster analysis*. New York, NY: Springer.
- Morgan, D. L. (2007). Paradigms lost and pragmatism regained: Methodological implications of combining qualitative and quantitative methods. *Journal of Mixed Methods Research*, 1(1), 48-76. doi:10.1177/2345678906292462
- Rhee, M. (2012). *Radical: Fighting to put students first*. New York, NY: Harper.
- Roberts, R., & Edwards, M. C. (2015). Service-learning's ongoing journey as a method of instruction: Implications for school-based, agricultural education. *Journal of Agricultural of Agricultural Education*, 56(2), 217-233. doi:10.5032/jae.2015.02217
- Roberts, R., & Edwards, M. C. (2017). *Imaging service-learning in The Agricultural Education Magazine from 1929-2009: Implications for the method's reframing and use*. Paper presented at the meeting of the American Association for Agricultural Education (AAAE) National Conference, San Luis Obispo, CA.
- Rogers, E. M. (2003). *Diffusion of innovations* (5th ed.). New York, NY: The Free Press.
- Saldaña, J. (2012). *The coding manual for qualitative researchers* (2nd ed.). Thousand Oaks, CA: Sage.

- Saltmarsh, J., & Hartley, M. (2008). *Democratic civic engagement: Higher education and democracy: The future of engagement*. Boston, MA: New England Resource Center for Higher Education.
- Speck, B. W., & Hoppe, S. L. (2004). *Service learning: History, theory, and issues*. Westport, CT: Praeger Press.
- Stake, R. E. (2006). *Multiple case study analysis*. New York, NY: Guilford Press.
- Tatebe, J. (2013). Bridging gaps: Service learning in teacher education. *Pastoral Care in Education, 31*(3), 240-250. doi:10.1080/02643944.2013.774044
- Teddlie, C., & Yu, F. (2007). Mixed methods sampling: A typology with examples. *Journal of Mixed Methods Research, 1*(1), 77-100. doi:10.1177/2345678906292430
- Tyack, D., Lowe, R., & Hansford, E. (1984). *Public schools in the hard times: The Great Depression and recent years*. Cambridge, MA: Harvard University Press.
- Whitehurst, G. J. (1984). Interrater agreement for journal manuscript reviews. *American Psychologist, 39*(1), 22-28. doi:10.1037/0003-066X.39.1.22
- Yang, F. Y., Chang, C. Y., & Hsu, Y. S. (2008). Teacher views about constructivist instruction and personal epistemology: A national study in Taiwan. *Educational Studies, 34*(5), 527-542. doi:10.1080/03055690802288486



## **Agricultural and Natural Resource Issues Education: Are We Teaching About Relationships?**

Alexa J. Lamm, University of Florida  
Jessica Harsh, University of Florida  
Courtney Meyers, Texas Tech University  
Ricky Telg, University of Florida

### **Abstract**

In order to be prepared for agricultural and natural resources (ANR) sector jobs, undergraduate students should be able to identify relationships between ANR issues. The purpose of this study was to determine if communication courses focused on teaching about ANR issues influenced undergraduate students' understanding of the relational nature of these issues. Undergraduate students in three universities' communication courses that address communicating about ANR issues were surveyed to identify the students' perceived relationships between ANR issues before and after the course, visualize the students' perceived relationships between ANR issues before and after the course, and determine the overall density of the perceived interconnections of ANR issues before and after the course. A pre/posttest research design was used. The 59 students in the three courses were asked to respond to 36 relational questions. Prior to taking the course, the strongest perceived relationship was between food safety and food security, followed by water and animal health. After taking the course, the strongest perceived relationship was between water and food security, followed closely by water and conservation, and water and animal health. Visually, water was central to the network of issues, followed by food security, and conservation. The density of the perceived interconnectedness among the issues indicated the respondents did perceive the nine ANR issues were more closely related after taking the course than before.

### **Introduction**

Undergraduate students in colleges of agriculture are the future of the agricultural and natural resources (ANR) workforce and must be prepared to handle the many and varied issues – both individually and collectively (DiBenedetto, Lamm, Lamm, & Myers, 2016) – facing the agricultural industry today (United States Department of Agriculture – National Institute of Food and Agriculture, n.d.). Some of the issues include food insecurity (DiBenedetto et al., 2016), space, natural resource management, energy consumption, climate change, and agricultural production (Andenoro, Baker, Stedman, & Pennington Weeks, 2016).

These issues are not independent of one another, but rather, they are all connected. For example, food security and the use of biotechnology, including genetic modification (which can be seen as contentious), are intertwined. Biotechnology is viewed by many as a solution to the food demands of an ever-growing population through the use of genetic modification (GM) (Godfray et al., 2010; LaJeunesse, 2015). Using biotechnology also impacts marketing and trade because GM crops increase yields and decrease inputs (Godfray et al., 2010; LaJeunesse, 2015), thereby increasing the potential for additional export availability that could assist in alleviating poverty in hard-to-reach parts of the world. Not only is biotechnology intertwined with food security, but also it is often discussed regarding food safety. Only 37% of Americans trust that GM food is safe to eat (Funk & Rainie, 2015) despite the scientific community repeatedly finding GM food safe to consume (National Academy of Sciences, 2016; Nicolia, Manzo,

Veronesi, & Rosellini, 2014).

Food safety, food security, and animal health are also connected. Concerns have risen related to animal antibiotics affecting human health because of possible antibiotic residue (Lee, Lee, & Ryu, 2001; National Research Council, 1999). In a study of consumers in Florida, over half of the respondents expressed concerns about antibiotic residue in meat products (Anderson, Ruth, & Rumble, 2014), even though the use of antibiotics has improved animal health and productivity to increase meat production over the last few decades (McDermott et al., 2002).

Animal health issues have also been impacted by invasive species, which leads to food security issues. In 2016, screwworm flies from South America and the Caribbean (Nordile, 2016a) caused alarm because this invasive species can be detrimental to livestock producers' herds (Nordile, 2016b). Thus, the invasive species had the potential to impact food security if the outbreak had not been handled cautiously. According to Huang, Rumble, and Lamm (2014), land misuse can be a result of the "introduction of non-native species" (p. 26). Huang and Lamm (2016) found Floridians expressed concerns about invasive species affecting ecosystem conservation. Not only do invasive species affect the conservation of land and water resources, but water issues impact conservation of the land. Huang, Lamm, and Rumble (2016) found respondents expressed concerns about animal waste and water run-off/quality as factors impacting conservation of the land. If the land was not conserved properly, it could impact food security should the land become unsuitable for farming.

Another factor making food production more difficult is climate change and variability. As the climate continues to change, agriculture has to adapt (United Nations, 2015). Using biotechnology, researchers have begun to combat the effects of climate change. For example, GM drought-tolerant sorghum with genetics resistant to stalk rot is being produced (Tesso, Claflin, & Tuinstra, 2005) to alleviate the losses associated with extreme weather events and lack of water availability.

Food security is also connected to water (Andenoro et al., 2016). Simply put, both crops and livestock require water. Mismanagement and scarcity of water resources impact the quality and sustainability of food, which impacts food security. The connections above are not the only connections between ANR issues. These examples serve as evidence as to why it is imperative to educate undergraduate students on ANR issues and help them develop an appreciation for the connectedness of the issues they will wrestle with as they become the leaders the ANR industry needs to advance the field.

It is important students learn how these issues interconnect with one another. Communication courses are a good place to start; students learn about a variety of ANR issues and how to discuss them appropriately in one learning environment. Courses that foster learning about the connectedness of issues help students become better equipped to address these controversial and complex ANR issues. Currently, there is a lack of research identifying the potential benefits of a course that includes this type of learning. One of those benefits is students comprehending the connectedness of the many issues facing the industry. This research explores the benefits of communication courses that include lessons about ANR issues in regard to how students perceive the interconnectedness of the issues.

## Theoretical Framework

This study is based on the concept of contextual learning, which is derived from experiential learning theory (Dewey, 1938), and brain-based theory (Caine & Caine, 1991). Experiential learning theory (Kolb, 1984) is the foundational backbone of student-driven education. Experiential learning is the application of educational materials to students' lives and contextual learning. Communication courses focused on learning about ANR issues are student-centered; the courses are designed to help undergraduate students understand ANR issues and realize the issues do not stand alone. By focusing on contextual learning, students learn to think critically and actively apply knowledge to complex situations (Baker & Robinson, 2016).

In contextual learning, the experience of the classroom will help undergraduate students make connections between issues and how they play out in the real world because direct experience with an issue is expected to impact later experiences (Dewey, 1938). While students are not in a real-life situation when in the classroom, they are presented with real issues the ANR industry faces and are able to gain knowledge (Roberts, 2006) they can apply later in their careers. Through contextual learning, undergraduate students gain continuity, which promotes the growth of learning and the ability to better conceptualize connections between concepts (Dewey, 1938).

Knobloch, Ball, and Allen (2007) found high school and middle school student teachers believed "agriculture provided connections for their students" (p. 29). The teachers also believed teaching in the context of agriculture allowed students to be connected to the world around them. For example, the teachers expressed the importance of learning the water cycle and its connection to soil formation and the seasons (Knobloch et al., 2007). Along those same lines, Theimer and Ernst (2013) found students who spent more time outdoors with their teacher displayed "high levels of connectedness to nature" (p. 84-85).

Mueller, Knobloch, and Orvis (2015) conducted an experimental study examining differences in students' perceptions of biotechnology and genetics as integrated science topics related to food production sustainability and human health when actively engaged in experiential techniques versus traditional teaching methods. They discovered students who were in the active learning treatment group, based on experiential learning theory, were more likely to contextualize, think critically, and understand the topics of biotechnology and genetics. Students in the treatment group also scored significantly higher in the application of biotechnology and genetics than the control group (Mueller et al., 2015). Balschweid (2001) also concluded experiential learning provided a connection between content and context to address complex problems. In this study, students who took a biology class using animal agriculture as the context understood the role science played in production agriculture better than those in a traditional biology class (Balschweid, 2001).

In addition to the foundation of experiential learning, the brain-based theory provides additional context. According to Caine and Caine (1991), "a subject is always related to many other issues and subjects" (p. 7). Brain-based learning is the process of connecting information being taught and students' previous experiences (Caine & Caine, 1991). Every person is touched by the ANR industry so a connection to the industry can be easily made. Communications courses can serve as a learning tool to assist students in completing the connection between ANR issues they have already been exposed to daily. Past research has looked at the connections middle school, and high school students make while in the classroom with limited research

addressing how undergraduate students assess the connectedness of larger issues in an agricultural context.

### **Purpose and Objectives**

The purpose of this study was to determine if communication courses that include content about ANR issues influenced undergraduate students' understanding of the relational nature of ANR issues. The purpose was fulfilled through the following objectives:

1. Identify undergraduate students' perceived relationships between ANR issues before and after taking a communications course focused on ANR issues.
2. Visualize undergraduate students' perceived relationships between ANR issues before, and after taking communications course focused on ANR issues.
3. Determine the overall density of the perceived interconnectedness of ANR issues before, and after taking a communications course focused on ANR issues.

### **Methods**

A pre/posttest research design was used to address the objectives of the study. Perceived relationships between a series of ANR issues were measured on the pretest and posttest using a researcher-developed scale, which required respondents to indicate the level to which they believed each of the nine issues were connected to one another on a five-point semantic differential scale ranging from zero to four (0 = *not at all connected*, 4 = *completely connected*). In total, respondents were asked to respond to 36 relational questions. The nine-issue areas were animal health, biotechnology, climate variability and change, conservation, food safety, food security, invasive species, marketing and trade, and water.

Content and face validity of the pretest and posttest were determined by a panel of experts that included an assistant professor at the University of Florida who specializes in instrument development, an associate professor at Texas Tech University specializing in issues education and agricultural communication, and the director of the UF/IFAS Center for Public Issues Education at the University of Florida. The instruments were pilot-tested with a group of graduate students to ensure understanding and clarity. Cognitive interviews were conducted to build a strong understanding of any misconceptions related to question wording. Minor adjustments to wording in the stem of the questions were made, and examples within each of the nine issue areas were added as a result of the pilot test.

Undergraduate students enrolled in a communications course focused on ANR issues were the population of interest for this study. Fifty-nine students enrolled in communication courses at the University of Florida, Texas Tech University, and Colorado State University were selected purposively as the sample since the courses were being offered at all three during the spring semester in 2016. Enrollment was consistently open to students from a diverse array of colleges at all three universities.

Students were provided with a pretest on the first day of class and a posttest on the last day of class. A 44% response rate was obtained with 26 complete pre/posttests collected that were able to be matched. The low response rate is a limitation, making the results only generalizable to those who completed both the pretest and posttest. However, non-response bias was addressed using Chi-squared tests, comparing respondents' gender and college rank to non-respondents. No significant differences were found; therefore, the sample was determined to be

representative of the students enrolled in all three courses. Eight of the respondents were from the University of Florida, nine from Texas Tech University, and ten from Colorado State University.

Demographics were collected on the pretest. This included race, gender, college rank, and college major. All of the participants were White and Non-Hispanic, and their age ranged from 20 to 24 years old. Most of the respondents were female (80.8%) and represented all four college classes: freshman (7.7%), sophomores (15.4%), juniors (38.5%), and seniors (38.5%). Most of the respondents reported an Agricultural Education, Leadership, and/or Communication major (65.4%). Several reported a Journalism and Media Communication major (18.5%) and Agricultural Literacy major (7.7%). One of the respondents reported having an Environmental communications major, and one reported a Natural Resource Recreation and Tourism major.

Means were calculated for each of the perceived relationships on the pretest and the posttest individually. Change in the overall mean for each of the perceived relationships from pretest to posttest was also calculated. Paired *t*-tests were then used to determine if there were statistically significant differences in perceptions before and after the course. A significance level of .05 was established *a priori*. The mean scores were then imported into Ucinet 6 (Borgatti, Everett, & Freeman, 2002), a social network analysis software, to visualize the respondents' perceived relationships between the nine issues as individual connections, as well as a broader network of issues that were interconnected. The analysis allowed the data to be viewed visually to see which issues were more central within the broader group of issues from the respondent's perspective, the density of relationships between multiple issues, and the intensity of the perceived relationships. The placement of the nodes (each of the nine ANR issues) within the broader network of nodes (group of ANR issues) was visually examined, and the width of the ties between the nodes were used to indicate the strength of the perceived relationships (Borgatti, Everett, & Johnson, 2011). Ucinet 6 (Borgatti et al., 2002) was also used to calculate the density of the perceived interconnectedness of the ANR issues overall on the pretest and posttest (Borgatti et al., 2011). Density is the proportion of direct ties in a network relative to the total number possible (Xu, 2010) and, in this case, is an identifier of how related respondents perceived the issues to be with one another as a network. A higher density statistic indicates a higher level of density within a network.

## Results

### Perceived Relationships Between ANR Issues

The respondents' perceived relationships between ANR issues were examined before and after taking the communications course (see Table 1). Prior to taking the course, the strongest perceived relationship was between food safety and food security ( $M = 3.23$ ), followed by water and animal health ( $M = 3.19$ ). After taking the course, the strongest perceived relationship was between water and food security ( $M = 3.28$ ), closely followed by water and conservation ( $M = 3.24$ ), and water and animal health ( $M = 3.23$ ).

Prior to taking the course, the weakest perceived relationship was between conservation and marketing and trade ( $M = 1.81$ ). It was followed by conservation and food safety ( $M = 1.88$ ). After taking the course, the only perceived relationships with a mean score lower than two on the scale ranging from zero to four was between conservation and food safety ( $M = 1.92$ ).

The relationships with the largest reported differences in mean score from the pretest to the posttest were between conservation and biotechnology (+.62) and conservation and marketing and trade (+.58). Although they were the largest changes, they were not significantly different when a paired *t*-test was conducted. However, the differences in perceived relationships between conservation and invasive species (+.34), climate change and water (+.31), food safety and water (+.27) food security and water (+.12), and invasive species and water (+.04) all had positive, statistically significant changes.

Several relationships had a negative change with the largest occurring between animal health and food safety (-.38), indicating the respondents felt these two issues were less related after the course than before. However, the change in response to this item was not statistically significant. The only statistically significant negative change was between food safety and invasive species (-.08).

Table 1

*Perceived Relationships Between ANR Issues Before and After Taking the Course*

Issue 1	Issue 2	N	Pretest M (SD)	Posttest M (SD)	Mean Difference
Conservation	Biotechnology	26	2.00 (0.98)	2.62 (1.02)	0.62
Conservation	Marketing & Trade	26	1.81 (0.94)	2.38 (1.02)	0.58
Climate Change	Marketing & Trade	26	1.92 (1.09)	2.46 (1.10)	0.54
Food Security	Invasive Species	26	2.19 (1.13)	2.62 (0.94)	0.42
Biotechnology	Water	25	2.40 (1.12)	2.80 (1.04)	0.40
Climate Change	Food Safety	26	2.00 (1.09)	2.38 (1.24)	0.38
Conservation	Invasive Species	26	2.81 (1.30)	3.15 (0.88)	0.34*
Biotechnology	Climate Change	26	2.11 (1.24)	2.46 (0.90)	0.35
Biotechnology	Food Security	25	2.84 (1.14)	3.16 (1.11)	0.32
Climate Change	Water	26	2.96 (1.15)	3.27 (0.87)	0.31*
Climate Change	Food Security	26	2.23 (1.21)	2.54 (1.17)	0.31
Climate Change	Invasive Species	26	2.46 (1.14)	2.77 (0.99)	0.31
Animal Health	Marketing & Trade	26	2.23 (1.21)	2.54 (1.10)	0.31
Food Safety	Water	26	3.11 (1.03)	2.85 (1.16)	0.27*
Climate Change	Conservation	26	2.77 (1.14)	3.00 (0.89)	0.23
Invasive Species	Marketing & Trade	26	2.15 (1.05)	2.35 (1.16)	0.19
Water	Marketing & Trade	26	2.54 (0.86)	2.69 (1.09)	0.15
Animal Health	Conservation	26	2.81 (1.06)	2.96 (0.91)	0.15
Food Security	Water	25	3.16 (0.85)	3.28 (0.79)	0.12**
Food Security	Marketing & Trade	26	2.96 (1.15)	3.08 (0.93)	0.12
Food Security	Food Safety	26	3.23 (1.18)	3.35 (0.94)	0.12
Conservation	Water	25	3.12 (1.20)	3.24 (0.93)	0.12
Animal Health	Biotechnology	26	2.27 (1.15)	2.38 (0.80)	0.11
Animal Health	Invasive Species	26	2.46 (1.24)	2.54 (0.99)	0.08
Biotechnology	Food Safety	25	2.60 (1.15)	2.68 (1.22)	0.08
Invasive Species	Water	25	2.77 (0.82)	2.73 (0.96)	0.04*
Animal Health	Water	26	3.19 (1.23)	3.23 (0.95)	0.04
Biotechnology	Invasive Species	25	2.32 (1.14)	2.36 (0.91)	0.04
Conservation	Food Safety	26	1.88 (1.03)	1.92 (1.09)	0.04
Animal Health	Climate Change	26	2.58 (1.10)	2.58 (0.99)	0.00
Animal Health	Food Security	26	2.77 (1.24)	2.73 (1.15)	-0.04
Food Safety	Invasive Species	25	2.36 (1.04)	2.28 (1.06)	-0.08*
Conservation	Food Security	26	2.46 (1.21)	2.35 (1.26)	-0.11
Food Safety	Marketing & Trade	26	3.00 (1.13)	2.81 (0.94)	-0.19
Biotechnology	Marketing & Trade	25	2.76 (1.05)	2.56 (1.04)	-0.20
Animal Health	Food Safety	26	2.88 (1.21)	2.50 (1.14)	-0.38

Note. 0 = Not at all related; 4 = Completely related; \* $p < 0.05$ ; \*\* $p < 0.01$ ; Animal Health (animal welfare, animal disease); Food Safety (foodborne illnesses); Marketing & Trade (imports/exports); Conservation (endangered species, land use); Biotechnology (GMOs); Invasive Species (not native to specific location); Food security (food availability, access and use); Water (water quality, water quantity, agricultural water use); Climate Change (carbon sequestration, greenhouse gas emissions, sea level rise)

## Visualization of the Perceived Relationships Between ANR Issues

The perceived relationships between the ANR issues were visualized using social network analysis software. The pretest results can be viewed in Figure 1. The darker lines indicate a stronger tie, and the lighter lines indicate weaker ties. Visually, water and food safety had the strongest ties to the eight other issues with darker lines indicating the strength of their relationships. Marketing and trade and climate change were the two issues with weaker ties.

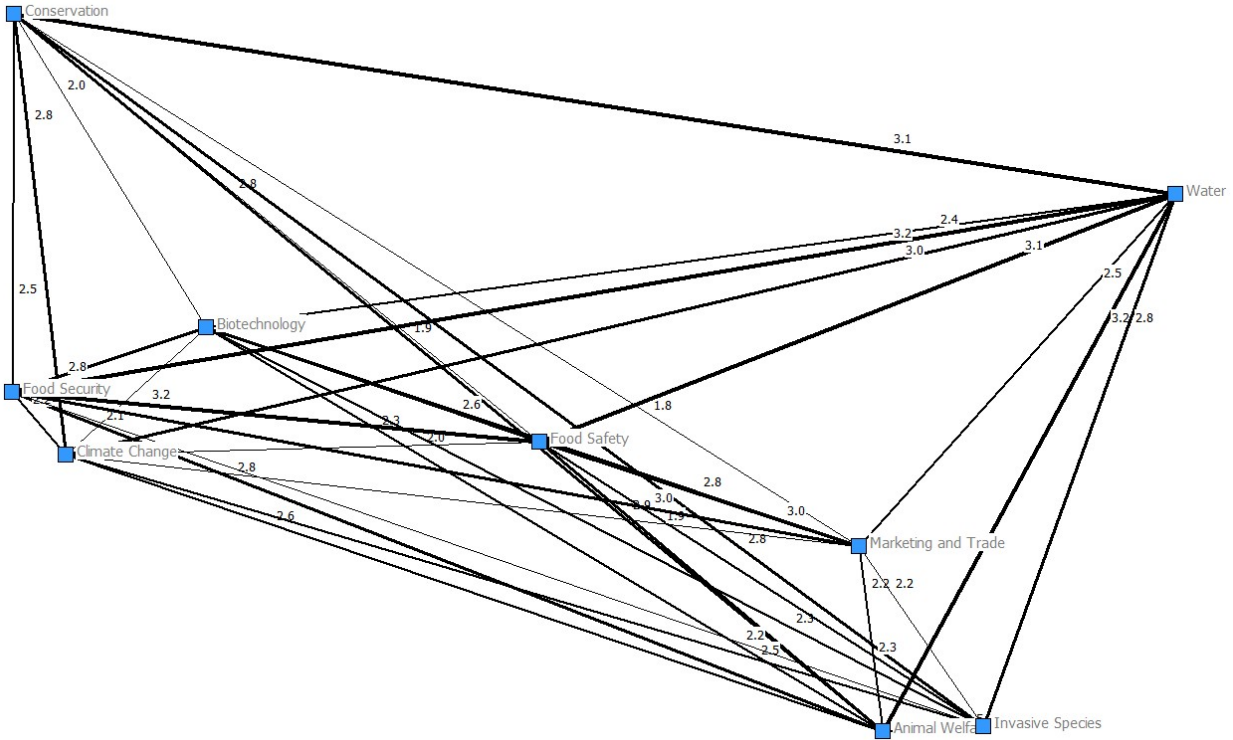

Figure 1. Perceived relationships between ANR issues before taking the course.

The perceived relationships between the ANR issues were then visualized using the results from the posttest and can be viewed in Figure 2. Visually, water was central to the network of issues with dark ties, and food security moved into a central position with dark ties to almost all of the other eight issues. Conservation also exhibited darker ties to the other issues. Biotechnology was placed at the far left with weaker ties to the other eight issues expressed.



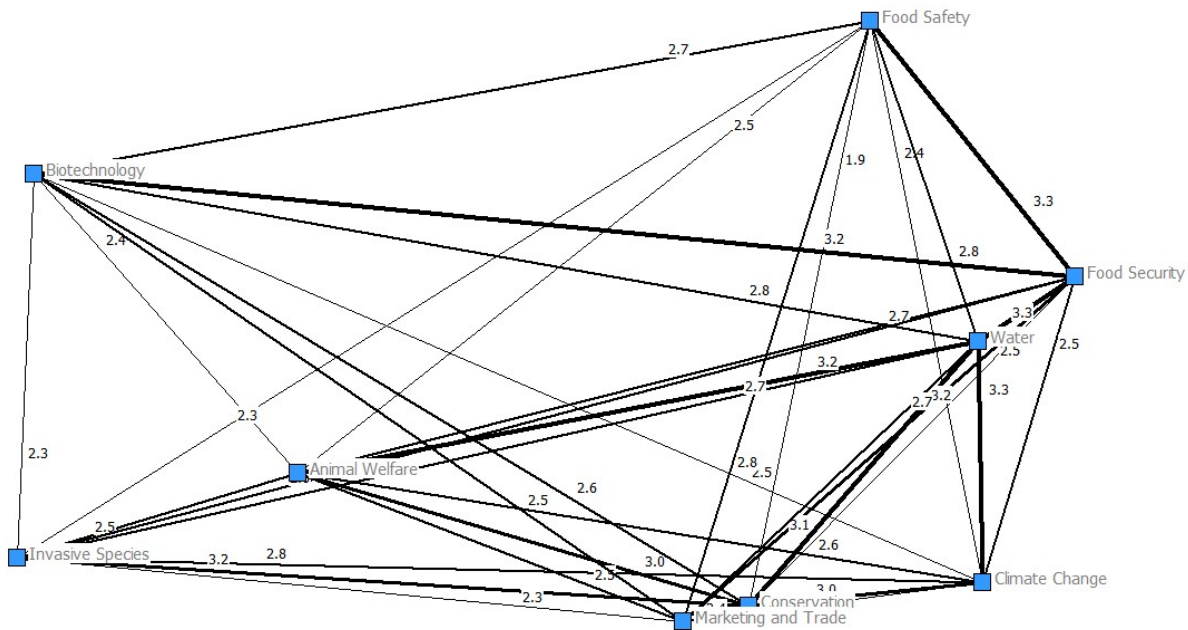

Figure 2. Perceived relationships between ANR issues after taking the course.

### Density of the Perceived Interconnectedness of ANR Issues

The density of the perceived interconnectedness of ANR issues was measured using density value (Table 2). The density value increased from pretest to posttest (+5.51). This result indicated the respondents did perceive the nine ANR issues were more closely related after taking the course than before.

Table 2.

*Density of the Perceived Overall Interconnectedness of ANR issues Before and After Taking an Agricultural Issues Course*

	<i>M</i>	<i>SD</i>	Total Density Value
Pretest	2.56	.40	92.07
Posttest	2.71	.34	97.58

Note. 0 = Not at all related; 4 = Completely related.

### Conclusions and Implications

As the undergraduate students of today become the workforce of tomorrow, they need to be equipped to address the many diverse issues facing the ANR industry (DiBenedetto et al., 2016; USDA-NIFA, n.d.). These issues vary from food insecurity to climate change, energy consumption to agricultural production (Andenoro et al., 2016; DiBenedetto et al. 2016) and are so intertwined that addressing one issue requires an understanding of how it will impact others. The purpose of this study was to determine if communication courses that include content about ANR issues influenced undergraduate students' understanding of the relational nature of ANR issues. In response to research objective one, the results indicated students did recognize the interconnectedness of ANR issues before the communication courses, but these relationships

were more evident after completing the course. Providing educational opportunities for students to learn about ANR issues through experiential learning has proven effective at encouraging critical thinking and understanding of these issues (Mueller et al., 2015). In addition, using agriculture as the context for learning has had positive learning outcomes for subjects as varied as biology (Balschweid, 2001) and the water cycle (Knobloch et al., 2007). The results of the current study indicated providing opportunities for students to learn about ANR issues seemed to clarify how the issues were more related than previously thought. With the emphasis on communication in these courses, students may now be better able to convey how the issues are interdependent when they enter the ANR workforce.

Although many factors may influence how students perceive the connectedness of ANR issues (e.g., educational background, personal upbringing), it appears these courses did provide an opportunity to help students make those connections more evident. This is supported by the finding that only one relationship had a low mean score. The results of the paired samples *t*-tests revealed gains in the perception of interconnectedness for 29 of the 36 pairs of relationships (one pair was consistent from the pretest to posttest). As students in the communications courses learned more about these issues, they began to better realize the connections between them as Dewey (1938) described would happen through contextual learning.

Several of the relationships that increased in strength have been noted by previous researchers such as the connection between food security and biotechnology (Godfray et al., 2010; LaJeunesse, 2015); food security and water (Andenoro et al., 2016); and invasive species and food security (Huang et al., 2014; Nordile, 2016a, 2016b). Additionally, all the relationships with climate change had gains except one, which did not change at all from pretest to posttest. The United Nations (2015) noted that agriculture will have to adapt to address the impacts of climate change and variability. Perhaps students hear more about climate change, and the data reflect the students' awareness of the reverberating impacts climate change could have on the ANR industry.

Research objectives two and three were addressed through additional exploration of the data. The results of the social network analysis visually depicted the relationships between the ANR issues. A comparison of the two figures draws attention to the number of connection lines that grow in strength between the two data collection points. The findings further illustrated how students conceptualized the relationships between the nine ANR issues addressed in this study, and the density value demonstrated the extent to which students viewed these issues as interconnected.

### **Recommendations**

As previously noted, the results of this study are limited in generalizability. Additional data collection with more students in similar courses could provide a better description of how post-secondary students view ANR issues and how courses impact perceived interconnectedness of ANR issues. While this study explored relationships between pairs of issues, this does not fully describe the interconnectedness of the ANR industry. The social network analysis gets closer to providing this picture, but it would be intriguing to see how additional ANR issues would fit. The nine issues identified for the current study represented a wide variety of issues, but it was not an exhaustive list. Future research should incorporate additional topics or simply ask students what other aspects of ANR are related to a specific issue. This would further

demonstrate students' ability to recognize the complex and multi-faceted nature of the ANR industry.

It would also be insightful to collect this interconnectedness data from other groups and within different contexts. Collecting this data from undergraduate students studying agriculture and life sciences at the beginning and end of their degree program could provide insight on how complete degree programs are having an impact. Students completing bench science degrees could then be compared to those completing social science degrees to see if there are differences in their perceptions. It would also be interesting to see if the students' enrollment in courses, such as the ones studied in this research, have an effect despite declared major.

Graduate students should also be studied. Not only are undergraduate students going out into the ANR industry, but graduate students will be serving as leaders within the industry and as future faculty and should be thinking about ANR issues holistically rather than as independent issues. How graduate education in agricultural education and communication is impacting graduate students' ability to see the interconnectedness of ANR issues is unexplored.

It would also be interesting to study industry leaders to see how their conceptualization of the relationships between ANR issues compares to what undergraduate students recognized in this study. Perhaps those working within specific areas of the ANR industry have a perspective that could add to the educational content shared in these courses. These perspectives could be used to build case studies that could be integrated into agricultural education courses, further advancing the contextualization of agricultural education and communication courses.

Additional research should explore additional cognitive gains such as knowledge about the ANR issues and the ability to communicate about them effectively. This data could be collected using qualitative methodology to provide richer descriptions of what students gain from courses such as the ones in this study. Future research could also explore specific pedagogical strategies that might influence students' understanding of the interconnectedness of these issues. Previous scholars have advocated for experiential learning, so perhaps the integration of case studies, undergraduate research projects, or service learning might further improve the education outcomes. As Caine and Caine (1991) stated, the process of connecting the information presented in the classroom to previous experiences reflects brain-based learning. As instructors strive to help students draw connections and gain a deeper understanding of the connectedness of ANR issues, they should seek opportunities to help students connect the concepts to prior knowledge.

As others have recognized, it is important that students be aware of and knowledgeable about a variety of ANR issues and how they are interconnected. Having this understanding would help students recognize how changes in one area (e.g., policy, markets, weather) might influence decisions for another sector of the industry. As the future decision-makers and leaders of the ANR industry, undergraduate students need to be adequately prepared to develop solutions that are feasible within constraints on resources. While many classes these students might complete during their degree plan are limited to a particular agricultural science discipline (e.g., animal science, plant science, natural resources), perhaps there is a need to provide an opportunity for students to gain exposure to the interconnected nature of ANR issues and propose potential solutions to challenges facing the industry.

## References

- Andenoro, A. C., Baker, M., Stedman, N. L. P., & Pennington Weeks, P. (2016). Research priority 7: Addressing complex problems. In Roberts, T.G., Harder, A., & Brashears, M. T. (Eds.) *American Association for Agricultural Education national research agenda: 2016-2020* (57-66). Gainesville, FL: Department of Agricultural Education and Communication. Retrieved from [http://aaaeonline.org/resources/Documents/AAAE\\_National\\_Research\\_Agenda\\_2016-2020.pdf](http://aaaeonline.org/resources/Documents/AAAE_National_Research_Agenda_2016-2020.pdf)
- Anderson, S., Ruth, T., & Rumble, J. (2014). *Public opinion of food in Florida*. PIE2011/12-17. Gainesville, FL: University of Florida/IFAS Center for Public Issues Education.
- Baker, M. A. & Robinson, J. S. (2016). The effects of Kolb's experiential learning model on successful intelligence in secondary agricultural student. *Journal of Agricultural Education*, 57(3), 129-144. doi: 10.5032/jae.2016.03129
- Balschweid, M. A. (2001, December). *Teaching biology using agriculture as the context: Perceptions of high school students*. Paper presented the 28th Annual National Agricultural Education Research Conference, New Orleans, LA.
- Borgatti, S. P., Everett, M. G., & Freeman, L. C. (2002). *Ucinet 6 for windows: Software for social network analysis*. Analytic Technologies, Harvard, MA.
- Borgatti, S. P., Everett, M. G., & Johnson, J. C. (2011). *Analyzing social networks*. Thousand Oaks, CA: SAGE.
- Caine, R. N., & Caine, G. (1991). *Making connections: Teaching and the human brain*. Retrieved from: <http://files.eric.ed.gov/fulltext/ED335141.pdf>
- Dewey, J. (1938). *Experience and education*. New York, NY: Touchstone.
- DiBenedetto, C. A., Lamm, K. W., Lamm, A. J., & Myers, B. E. (2016). Examining undergraduate student attitude towards interdisciplinary education. *Journal of Agricultural Education*, 57(1), 167-178. doi: 10.5032/jae.2016.01167
- Funk, C., & Rainie, L. (2015). *Public and scientists' views on science and society*. Washington D.C.: Pew Research Center. Retrieved from <http://www.pewinternet.org/2015/01/29/public-and-scientists-views-on-science-and-society/>
- Godfray, H. C. J., Beddington, J., Crute, I., Haddad, L., Lawrence, D., Muir, J., ... Toulmin, C. (2010). Food security: The challenge of feeding 9 billion people. *Science*, 327(5967), 812-818. Retrieved from <http://science.sciencemag.org/content/sci/327/5967/812.full.pdf?sid=d8e9be99-b991-4ccc-9a98-3a3c3df00bf8>
- Huang, P., & Lamm, A. J. (2016). Identifying invasive species educational needs in Florida: Opportunities for extension. *Journal of Extension*, 54(5). Retrieved from <https://joe.org/joe/2016october/rb7.php>
- Huang, P., Rumble, J., & Lamm, A. (2014). *CARES program with FFBF and Mosaic*.

PIE2013/14-4. Gainesville, FL: University of Florida/IFAS Center for Public Issues Education.

- Huang, P., Lamm, A. J., & Rumble, J. N. (2016). Public opinions of farmer-oriented environmentally friendly extension programs: A case of best management practices. *Journal of Human Science and Extension*, 4(3), 75 - 92. Retrieved from [http://media.wix.com/ugd/c8fe6e\\_e3b29a68929b47319bbcfaab96ff23a9.pdf](http://media.wix.com/ugd/c8fe6e_e3b29a68929b47319bbcfaab96ff23a9.pdf)
- Kolb, D. A. (1984). *Experiential learning*. Englewood Cliffs, NJ: Prentice-Hall, Inc.
- Knobloch, N. A., Ball, A. L., & Allen, C. (2007). The benefits of teaching and learning about agriculture in elementary and junior high schools. *Journal of Agricultural Education*, 48(3), 25-36. 10.5032/jae.2007.03025
- LaJeunesse, S. (2015). The science of GMOs. *Penn State Ag Science Magazine, Spring/Summer*. Retrieved from <http://agsci.psu.edu/magazine/articles/2015/spring-summer/the-science-of-gmos>
- Lee, M. H., Lee, H. J., & Ryu, P. D. (2001). Public health risk: Chemical and antibiotic residues – review. *Asian-Australasian Journal of Animal Sciences*, 14(3), 402-413. doi: <https://doi.org/10.5713/ajas.2001.402>
- McDermott, P. F., Zhao, S., Wagner, D. D., Simjee, S., Walker, R. D., & White, D. G. (2002). The food safety perspective of antibiotic resistance. *Animal Biotechnology*, 13(1), 71-84. doi: 10.1081/ABIO-120005771
- Mueller, A. L., Knobloch, N. A., & Orvis, K. S. (2015). Exploring the effects of active learning on high school students' outcomes and teachers' perceptions of biotechnology and genetic instruction. *Journal of Agricultural Education*, 56(2), 138-152, doi: 10.5032/jae.2015.02138
- National Academy of Sciences. (2016). *Genetically engineered crops: Experiences and prospects*. Retrieved from <http://www.nap.edu/catalog/23395/genetically-engineered-crops-experiences-and-prospects>
- National Research Council. (1999). *The use of drugs in food animals: Benefits and risks*. United States of America: National Academy of Sciences.
- Nicolia, A., Manzo, A., Veronesi, F., & Rosellini, D. (2014). An overview of the last 10 years of genetically engineered crop safety research. *Critical Reviews in Biotechnology*, 34(1), 77-88. doi:10.3109/07388551.2013.823595
- Nordile, T. (2016a). *UF experts addressing outbreak of New World screwworm fly in Florida Keys*. Retrieved from <http://news.ifas.ufl.edu/2016/10/uf-experts-addressing-outbreak-of-new-world-screwworm-fly-in-florida-keys/>
- Nordile, T. (2016b). *Florida residents should be vigilant for signs of screwworm on livestock and pets, UF experts say*. Retrieved from <https://news.ifas.ufl.edu/2016/10/florida-residents-should-be-vigilant-for-signs-of-screwworm-on-livestock-and-pets-uf-experts-say/>

- Roberts, T. G. (2006). A philosophical examination of experiential learning theory for agricultural educators. *Journal of Agricultural Education*, 47(1), 17-29. doi: 10.5032/jae.2006.01017
- Tesso, T. T., Claflin, L. E., & Tuinstra, M. R. (2005). Analysis of stalk rot resistance and genetic diversity among drought tolerant sorghum genotypes. *Crop Science*, 45(2), 645-652. doi: 10.2135/cropsci2005.0645
- Theimer, S., & Ernst, J. (2013). Fostering “connectedness to nature” through U.S. fish and wildlife service education and outreach programming: A qualitative evaluation. *Applied Environmental Education & Communication*, 11(2), 79-87. doi: 10.1080/1533015X.2012.751281
- United States Department of Agriculture – National Institute of Food and Agriculture. (n.d.). *Challenge areas*. Retrieved from <https://nifa.usda.gov/challenge-areas>
- United Nation’s Human Settlement Program. (2015). *UN-habitat urban data* [Data file]. Retrieved from <http://urbandata.unhabitat.org/>
- Xu, G. (2010). *Web mining and social networking: Techniques and applications*. New York, NY: Springer.

## Relationship between Student Pre-Entry Attributes and Six-Year Degree Completion

Catherine W. Shoulders, University of Arkansas  
Leslie D. Edgar, University of Arkansas  
Don M. Johnson, University of Arkansas

### Abstract

This study examined the six-year graduation status of freshmen ( $N = 1,839$ ) entering a College of Agricultural, Food and Life Sciences (AFLS) between 2001 and 2010. The overall graduation rate was 64%, including 23% who had transferred out of AFLS. Multinomial logistic regression was used to determine if student data could differentiate between graduates and non-graduates and between AFLS and non-AFLS graduates. High school GPA (HSGPA), first-generation status, and year of entry significantly ( $p < .001$ ) differentiated between graduates and non-graduates. Each standard deviation increase in HSGPA was associated with a 224% increase in the relative odds of graduating; students entering each subsequent year had a 10% increase in the odds of graduating. Being a first-generation student decreased the relative odds of graduating by 52%. Year, major (agriculture or human environmental sciences), and composite ACT score (CACT) significantly ( $p < .001$ ) differentiated between AFLS and non-AFLS graduates. Students entering each subsequent year had a 16% increase in the relative odds of being AFLS graduates, while agriculture majors were slightly more than twice as likely to be AFLS graduates. Each standard deviation increase in CACT score was associated with a 26% decrease in the relative odds of being an AFLS graduate.

### Introduction and Theoretical Framework

The need for an increase in the number of graduates with degrees in agriculture, food, and natural resources (AFNR) has been well documented. In 2006, the USDA announced that 40-45% of the industry's employment pool was comprised of applicants with qualifications in "allied higher education programs such as biological sciences, engineering, business, health sciences, communication, and applied technologies" (p. 3). In 2009, the National Research Council called for changes in higher education in order to reduce the shortage of qualified AFNR graduates. In 2014, the STEM Food and Ag Council sounded the alarm again; "we are not producing nearly enough...professionals to meet industry demand—which continues to grow year after year" (p. 9). In 2016, the American Association of Agricultural Educators (AAAE) stated in its National Research Agenda, "the range of issues and subject matters important to agriculture has broadened, and the educational system to provide skilled individuals to fill the needed occupations has scrambled to keep pace" (Roberts, Harder, & Brashears, 2016, p. 30).

While recruitment efforts have assisted in reducing the gap between workforce needs and available human capital (Roberts et al., 2016), stalled graduation rates continue to temper increases in recruitment (NRC, 2009). The number of students recruited to pursue AFNR degrees has increased; however, "the number of students earning degrees in agriculture has been relatively stable since 2000 (NRC, 2009, p. 26). Efforts taken to understand the gap between enrollment in AFNR degree programs and graduation from AFNR degree programs can assist institutions of higher education in taking action to improve graduation rates.

Tinto (1975, 1993) developed a widely accepted model of student attrition from higher education (Figure 1). According to this model, student pre-entry attributes contribute to the development of tentative academic and institutional goals and commitments that students bring with them as they enter institutions of higher education. Once enrolled, students interact with the formal and informal academic and social systems present in the institution, resulting in a greater or lesser degree of academic and social integration into the institution, and to the reaffirmation, reconsideration, or revision of the previous academic and institutional goals and commitments. These academic and institutional goals, together with the student's external commitments lead to student decisions about attrition or retention, and ultimately graduation.

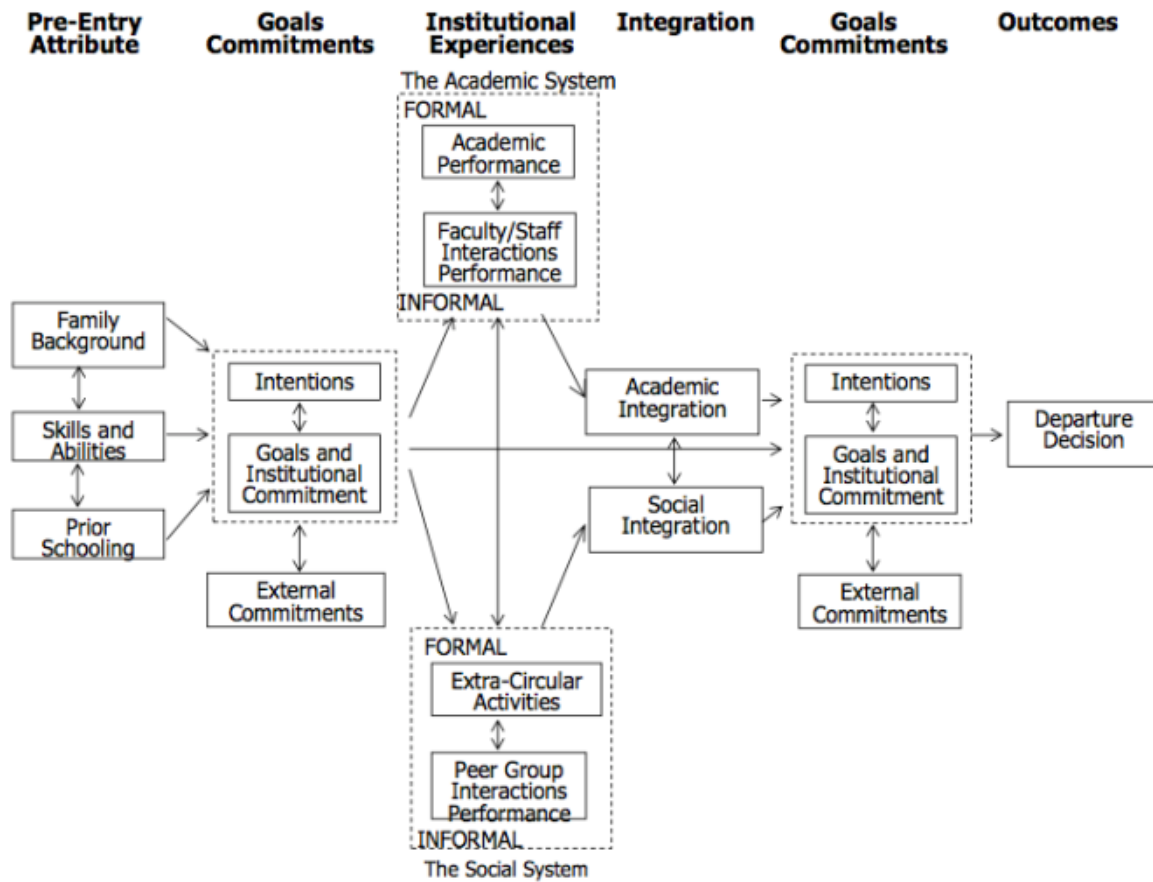

Figure 1. Tinto's (1993) longitudinal model of student attrition from higher education.

Within four-year institutions with more than one college, the specific college in which a student is enrolled can impact his or her experiences, which then interacts with his or her pre-entry characteristics (Wohlgemuth, Whalen, Sullivan, Nading, Shelley, & Wang., 2007). An examination of how each of these pre-college factors influences AFNR students' likelihood to graduate can shape university efforts by allowing them to mitigate the effects of specific variables shown to put students at-risk of dropping out (Astin & Oseguera, 2005; DeAngelo, Franke, Hurdado, Pryor, & Tran, 2011; Tinto, 1993).



These pre-college factors have been the subject of numerous studies, some with conflicting findings. In 2005, Astin and Oseguera reported an overall six-year graduation rate of 57.6% from a cohort of 3,700 four-year institutions. From the same cohort of institutions, DeAngelo and colleagues (2011) reported the six-year graduation rate has increased to 61.2%. In addition, these researchers found in the follow-up study, women graduated at a higher rate (63.6%) than their male counterparts (58.1%). They also discovered that first generation college students graduated at a lower rate (50.2%) than their counterparts who had at least one parent that attended college (64.2%), and those with higher high school GPAs or higher standardized test scores were more likely to graduate than their less academically prepared colleagues.

Wohlgemuth and colleagues (2007) predicted the likelihood of an Iowa State University student graduating at the end of six years, and found that females were more likely to graduate, as were those who received financial aid and those who entered their academic programs as students within the College of Agriculture. The authors found that while ACT score predicted four-year graduation rates, it did not do so for five- and six-year graduation rates.

Pike, Hansen, and Childress (2013) sampled 4,006 students at one Midwestern institution, examining their pre-college characteristics and degree status. They found that first-generation students were less likely to have graduated within six years of initial enrollment. Students with higher SAT scores and those with higher high school class percentile ranks were more likely to have graduated within six years.

Mau (2016) tracked 71,405 students in a Midwestern state pursuing degrees in science, technology, engineering, or math (STEM) for five years to identify characteristics that led to degree attainment. The five-year graduation rate within the STEM degree programs was 19.2%. Males graduated at a significantly higher rate than females. Additionally, significantly more transfer students completed degrees than did first-time freshmen. Race, ACT score, and high school GPA significantly predicted STEM degree completion.

The University of Arkansas where this study was conducted has a longstanding goal of increasing six-year graduation rates (Hale, Graham, & Johnson, 2009), with a current goal of improving from 62.5% in 2015 to 70% by 2021 (Dobrin, 2017). This study was conducted as part of the effort to reach this goal. In addition, this research directly supports AAAE Research Priority #3 which focuses on the development of the scientific and professional workforce for 21<sup>st</sup> Century agriculture (Stripling & Ricketts, 2016).

Colleges and universities collect large quantities of information about prospective students through the admissions and financial aid application processes. Much of this information deals directly with the pre-entry characteristics posited by Tinto (1993) as being the initial determinants of student attrition or retention and graduation. This study was conducted to determine the efficacy using this pre-entry student data to predict six-year graduation for entering freshmen in a College of Agricultural, Food and Life Sciences (AFLS).

## Purpose and Objectives

The purpose of this study was to determine if university admissions data could be used to predict six-year graduation for first time, fulltime freshmen enrolling in the College of Agricultural, Food, and Life Sciences (AFLS) at the University of Arkansas from 2001 to 2010. Specific objectives were to:

1. Determine the six-year degree status (graduated, enrolled, or not enrolled) of first time, fulltime freshman admitted to AFLS from 2001 to 2010;
2. Determine if selected variables (admission year, high school GPA, composite ACT score, gender, major, Pell Grant eligibility, and first generation college student status) could differentiate between students graduating (in any major) and students not graduating from the University of Arkansas for first time, fulltime freshmen entering AFLS from 2001 to 2010; and
3. Determine if selected variables (admission year, high school GPA, composite ACT score, gender, major, Pell Grant eligibility, and first generation college student status) could differentiate between AFLS graduates and non-AFLS graduates for first time, fulltime freshmen entering AFLS from 2001 to 2010.

## Methods

The population for this study included all students entering AFLS as new, first-semester, fulltime freshmen ( $N = 1839$ ) from 2001 to 2010. After institutional IRB approval, the Office of Institutional Research (OIR) provided the researchers with a data file containing the following admissions data for each student: year admitted, high school GPA (HSGPA), composite ACT score (CACT), major (categorized as human environmental sciences or agriculture), Pell grant eligibility, and first generation college student status. Complete admissions data were available for 1,672 (90.9%) total students and for 1,272 (92.0%) of the 1,176 students who graduated in six years. Descriptive statistics are reported for all ( $N = 1,839$ ) students; logistic regression results are limited to complete cases remaining after outliers were removed ( $n = 1,606$ ).

The OIR also supplied matched data for each student's sixth-year graduation outcome (graduated; enrolled, but not graduated; or not enrolled) and the student's undergraduate college (for graduates and currently enrolled students) or the last college of enrollment (for students no longer enrolled). The dataset was deemed valid and reliable because it consisted of official university records supplied by the OIR.

Descriptive statistics and logistic regression were used to analyze the data. According to Peng and colleagues (2002), "logistic regression is well suited for describing and testing hypotheses about relationships between a categorical outcome variable and one or more categorical or continuous predictor variables" (p. 4). To meet the study objectives, two logistic regression models were estimated. The first model sought to identify variables differentiating between six-year Graduates and Non-Graduates; the second model sought to differentiate between sixth-year

AFLS Graduates and students transferring to and graduating from other undergraduate colleges (Non-AFLS Graduates).

Prior to logistic regression analysis, the continuous variables (CACT and HSGPA) were converted to  $z$  scores as recommended by Osborne (2015). Year of entry (Year) was converted to a 10-point basis (2001 = 1 to 2010 = 10). Values for all binary categorical variables were coded as either zeros or ones (Table 1).

Table 1

*Variable Coding for Logistic Regression*

Variable	Coding
Gender	Female = 0 Male = 1
Major	Human environmental sciences = 0 Agriculture = 1
Pell Grant eligible	No = 0 Yes = 1
First generation college student	No = 0 Yes = 1
Instate student	No = 0 Yes = 1
HSGPA	Converted to $z$ scores
CACT	Converted to $z$ scores
Year	2001 = 1 to 2010 = 10
Six-year graduation status	Not graduated = 0 Graduated = 1
College of graduation	Non-AFLS = 0 AFLS = 1

The assumptions of logistic regression differ from those of ordinary least squares (OLS) regression. Logistic regression, a non-parametric method, does not require the OLS assumptions of linearity, normality, and homoscedasticity (Osborne, 2015). The two primary assumptions of logistic regression are independence of error terms and linearity of continuous independent variables and log odds (Peng, Lee, & Ingersoll, 2002). Independence of error terms was assumed because each observation in the dataset represented one unique student. Linearity of the three continuous independent variables (HSGPA, CACT, and Year) and their respective log odds was assessed using procedures recommended by Field, Miles, and Field (2012). The results indicated the linearity assumption was not violated.

The dataset was examined for outliers and leverage points by plotting and testing the significance of the standardized residuals as recommended by Osborne (2015); 66 observations (3.4%) were removed from the dataset leaving 1,606 observations for analysis. Analysis of the deleted observations indicated these students were primarily a unique subgroup of Non-Graduates, characterized by above average CACTs ( $z = 0.35$ ) and HSGPAs ( $z = 0.87$ ).

## Results

Of the 1,839 new, first-semester freshmen entering AFLS from 2001 to 2010, a majority were female (69.0%) and had majors in agriculture (62.1%), as opposed to human environmental sciences. Females comprised a slight majority (53.2%) of agriculture majors and the vast majority (94.7%) of human environmental sciences majors.

Approximately one-fourth of freshmen were from out-of-state (23.3%) and were first-generation college students (24.0%). Approximately one-fifth of freshmen were eligible for Pell grants (19.1%). The students had a mean HSGPA of 3.55 ( $SD = 0.44$ ), with a range of 1.42 to 5.0. The mean CACT score was 24.70 ( $SD = 3.71$ ), with a range of 15.0 to 35.0.

For new, first semester freshmen entering AFLS between 2001 and 2010, the overall six-year graduation rate was 64.0% (Table 2). Over one-third (36.2%) of these graduates had transferred out of AFLS and graduated from other colleges. Of the remaining students, 44 (2.4%) were still enrolled as undergraduates and 619 (34.7%) had not received a degree and were not enrolled six years after entering AFLS as freshmen.

Table 2

*Overall Six-Year Retention and Graduation Rates for New Freshmen, 2001 to 2010*

Outcome	<i>f</i>	%
Graduated (total)	1176	64.0
AFLS	750	40.8
Non-AFLS	426	23.2
Enrolled (total)	44	2.4
AFLS	18	1.0
Non-AFLS	26	1.4
Not Enrolled (total)	619	33.7

Overall, six-year graduation rates trended upward for new freshmen entering AFLS from 2001 to 2010, increasing from 58.8% to 67.5%. Year of entry had a moderate correlation (Davis, 1971) with six-year graduation rates ( $r = .34$ ). Because of this relationship, year of entry was retained as a potential predictor in logistic regression analyses.

The correlations between year and HSGPA ( $r = .01$ ) and CACT ( $r = .06$ ) were negligible (Davis, 1971). The point-biserial correlations between year and gender ( $r_{pb} = -.01$ ), Pell grant eligibility ( $r_{pb} = .01$ ), and majoring in agriculture were negligible ( $r_{pb} = -.10$ ), while the correlations between year and instate status ( $r_{pb} = -.14$ ), and first-generation status ( $r_{pb} = .17$ ) were low (Davis, 1971).

### Model 1: Graduates (Any Major) vs. Non-Graduates

The first stepwise logistic regression model compared students graduating in six years in any major (Graduates,  $n = 1,078$ ) with students not graduating in six years (Non-Graduates,  $n = 528$ ),

including students still enrolled. Graduates were entered as the reference group in this analyses, thus, positive logistic regression coefficients and Odds Ratios (*OR*) greater than one for a specific variable indicated increases in the variable were associated with increased odds of being a Graduate as opposed to a Non-Graduate, with all other variables held constant. Negative coefficients and *ORs* less than one indicated increases in the variable were associated with decreased relative odds of being a Graduate.

The global null hypothesis that no logistic regression coefficient was significantly different from zero was rejected,  $\chi^2(2) = 356.18, p < .001$ , pseudo- $R^2 = .29$ . Three variables entered into the model and were significant at the .001 *alpha* level: HSGPA, First-Generation student status, and Year (Table 3).

Table 3

*Results of Stepwise Logistic Regression Analyses Predicting Six-Year Graduation, Any Major, 2001 to 2010*

	Cumulative Pseudo- $R^2$	$\beta$ ( <i>SE</i> )	<i>CI</i> <sub>95</sub> for Odds Ratio		
			Odds Ratio	Lower Limit	Upper Limit
Intercept		0.55 (0.15)***			
HSGPA <sup>a</sup>	.26	1.18 (0.07)***	3.24	2.81	3.74
First-Generation Student	.28	-0.74 (0.14)***	0.48	0.36	0.63
Year	.29	0.09 (0.02)***	1.10	1.05	1.15

*Note.* <sup>a</sup>Converted to *z* scores. <sup>b</sup>Coded as no = 0 and yes = 1. <sup>c</sup>Coded as 2001 = 1 to 2010 = 10. \* $p < .05$ , \*\* $p < .01$ , \*\*\* $p < .001$ .

HSGPA was the first predictor to enter into the equation, resulting in a pseudo- $R^2$  of .26. The *OR* of 3.24 indicated each one standard deviation ( $z = 1.0$ ) increase in HSGPA was associated with a 224% increase [ $(OR - 1) * 100$ ] in the odds of being a Graduate as compared to a Non-Graduate. First-Generation entered second, with a negative regression coefficient and a pseudo- $R^2$  increase of .02. The *OR* of 0.48 indicated that being a first generation college student decreased the relative odds of being a Graduate by 52% [ $(OR - 1) * 100$ ]. Year entered last and provided a pseudo- $R^2$  increase of .01. The *OR* of 1.10 indicated students entering in each subsequent year had a 10% increase in the relative odds of being a Graduate as compared to students entering in the previous year.

The logistic regression model consisting of these three predictors correctly classified 73.8% of all observations into their correct six-year outcome (Graduate or Non-Graduate), Somers *D* = .55. The model was more accurate in predicting Graduates (89.1% correct) than in predicting Non-Graduates (42.6% correct).

## Model 2: AFLS Graduates vs. Non-AFLS Graduates

Of the 1,078 Graduates, 63.8% graduated from AFLS (AFLS Graduates), while 36.2% had transferred and graduated from a different college (Non-AFLS Graduate) at the University of Arkansas. The second stepwise logistic regression analysis was conducted to determine if the predictor variables could differentiate between these two groups. AFLS Graduates were used as the reference group, so, again, positive regression coefficients and *ORs* greater than one indicated increases in the predictor variables were associated with increased odds of being an AFLS-Graduate as opposed to a Non-AFLS Graduate, with all other variables held constant.

The global null hypothesis that no logistic regression coefficient was significantly different from zero was rejected,  $\chi^2(1) = 34.16, p < .001, \text{pseudo-}R^2 = .09$ . Three variables entered into the model and were significant at the .001 *alpha* level: Year, Major, and CACT (Table 4).

Table 4

*Results of Stepwise Logistic Regression Analyses Predicting Six-Year AFLS vs. Non-AFLS Graduates*

	Cumulative Pseudo- $R^2$	$\beta$ ( <i>SE</i> )	Odds Ratio	<i>CI</i> <sub>95</sub> for Odds Ratio	
				Lower Limit	Upper Limit
Intercept		-0.69 (0.18)***			
Year <sup>a</sup>	.04	0.14 (0.02)***	1.16	1.10	1.21
Major <sup>b</sup>	.07	0.78 (0.14)***	2.19	1.66	2.88
CACT <sup>c</sup>	.09	-0.31 (-0.07)***	0.74	0.64	0.84

*Note.* <sup>a</sup>Coded as 2001 = 1 to 2010 = 10. <sup>b</sup>Major coded as 0 = human environmental sciences and 1 = agriculture. <sup>c</sup>Converted to *z* scores.

\* $p < .05$ , \*\* $p < .01$ , \*\*\* $p < .001$ .

Year was the first predictor to enter into the equation, resulting in a pseudo- $R^2$  of .04. The *OR* of 1.16 indicated each subsequent year of entry increased the relative odds of being an AFLS Graduate by 16% over graduates entering in the previous year. Major entered second resulting in a pseudo- $R^2$  increase of .03. The *OR* of 2.19 indicated the relative odds of students entering AFLS as agriculture majors were slightly more than twice as likely to be AFLS Graduates as students entering as human environmental sciences majors. CACT entered last, with a negative regression coefficient, and resulted in a pseudo- $R^2$  increase of .02. The *OR* of 0.74 indicated a one *SD* ( $z = 1.0$ ) increase in CACT was associated with a 26% decrease in the relative odds of being an AFLS graduate.

The logistic regression model consisting of these three predictors correctly classified 65.5% of all graduates into the correct category (AFLS Graduate or Non-AFLS Graduate), Somers' *D* = .32. The model correctly predicted 67.3% of AFLS Graduates and 54.8% of Non-AFLS Graduates, showing a predictive bias in favor of AFLS Graduates.

## Discussion, Conclusions, and Recommendations

Tinto's (1993) theory of student departure and Wohlgemuth and colleagues (2007) outlined the importance of understanding how student characteristics and college experiences influence student success. This study examined the six-year graduation status of new, first-semester ( $N = 1,839$ ) entering a College of Agricultural, Food, and Life Sciences (AFLS) between 2001 and 2010. Overall, six-year graduation rates trended upward for new freshmen entering AFLS majors about 10% within the 10 years of study. Year of entry had a moderate correlation (Davis, 1971) with six-year graduation rates. The overall graduation rate for students was 64%, including 23% who had transferred out of AFLS.

In this study, the first stepwise logistic regression model compared students graduating in six years in any major (Graduates,  $n = 1,078$ ) with students not graduating in six years (Non-Graduates,  $n = 528$ ). The global null hypothesis that no logistic regression coefficient was significantly different from zero was rejected and three variables were found to be significant ( $p < .001$ ): high school GPA (HSGPA), First-Generation student status, and Year. Each standard deviation increase in HSGPA was associated with a 224% increase in the relative odds of graduating; students entering each subsequent year had a 10% increase in the odds of graduating. Conversely, being a first-generation college student decreased the relative odds of six-year graduation by 52%.

These findings lead to two divergent strategies for improving six-year graduation rates: improved students or an improved university. The first strategy is to emphasize recruitment of the high-GPA freshmen with college-educated parents who are most likely to graduate. Such an approach would focus on increasing the quality of entering students and less on improvement of the college and university into which these students enter. The second strategy is more difficult, but more consistent with this university's land-grant mission. This strategy would entail using these results to identify and provide academic assistance and needed services to lower-GPA and first-generation students designed to help overcome potential barriers to graduation. Emphasis on this strategy would necessarily focus on improvements to the college and university so these students are better served. The authors recommend the second strategy.

The second stepwise logistic regression analysis was conducted to determine predictor variables differentiating AFLS Graduates and Non-AFLS Graduates. The global null hypothesis that no logistic regression coefficient was significantly different from zero was rejected and three variables were loaded due to significance ( $p < .001$ ): Year, Major (agriculture vs. human environmental sciences), and composite ACT score (CACT). Students entering each subsequent year (2001-2010) had a 16% increase in the relative odds of being AFLS graduates, while agriculture majors were slightly more than twice as likely to be AFLS graduates. Each standard deviation increase in CACT score was associated with a 26% decrease in the relative odds of being an AFLS graduate.

Although the specific reasons agriculture majors were more likely than human environmental sciences majors to graduate from AFLS could not be determined from the data, the authors posit this may be a result of agriculture students' backgrounds and self-identity with agriculture and rural life (Shoulders & Myers, 2011). Research in this area is definitely warranted. In the

meantime, human environmental sciences faculty and administrators should open a dialogue with undergraduate students to identify factors related to their increased likelihood to transfer out of AFLS.

The finding that students with higher CACT scores were relatively more likely to be non-AFLS graduates also warrants further study. Future research should focus on why these students leave AFLS and into which colleges and majors they transfer. In the meantime, AFLS faculty and administrators should more fully engage these students in the college honors program, with faculty mentors, and in undergraduate research experiences in an effort to retain these high-ability AFLS students (Edgar, Whitehead, & Davis, 2017).

There were relative year-to-year improvements in both overall six-year graduation rates (10% per year) and in AFLS-retained graduation rates (16% per year) over the 10 year period. Improving six-year graduation rates has been a longstanding priority for both the university and for AFLS (Hale, Graham, & Johnson, 2009). The results of this study provide evidence of success in achieving this goal. Thus, these efforts should be continued and expanded. Concerns regarding the need for increased graduates with degrees in agriculture, food, and natural resources (AFNR) and in STEM fields have been well documented (NRC, 2009; Roberts et al., USDA, 2006). This research was an attempt to understand specific characteristic of students entering our College of AFLS. By better understanding our students, recruitment and retention strategies can be modified and developed to better meet the needs of students who are finding success (as denoted in graduation status) on our campus. By better understanding how pre-college factors influence AFLS students' likelihood to graduate, college and university efforts to mitigate the effects of specific variables identified as putting students at-risk of dropping out (Astin and Oseguera, 2005; DeAngelo et al., 2011; Mau, 2016; Pike et al., 2013; Wohlgenuth et al., 2007) can be addressed.

This study identified specific student pre-entry characteristics with potential to predict which new freshmen entering AFLS are most likely to graduate from the university in any major and those most likely to graduate in AFLS majors. This finding supports the importance of pre-entry student characteristics as posited in Tinto's (1993) model of student attrition.

Colleges of agriculture should use student data to make informed decisions regarding recruitment and retention strategies for students in their programs. Thus, potentially meeting the employment demands needed in agriculture, food, and natural resources fields. Further research should continue on all campuses to better understand the needs of our students and introduce mitigation and programmatic areas for student success (i.e. graduation).

### **Literature Cited**

- Astin, A. W., & Oseguera, L. (2005). Pre-college and institutional influences on degree attainment. In A. Seidman (Ed.), *College student retention: Formula for student success* (pp. 245-276). Westport, CT: American Council on Education/Praeger.
- Davis, J. A. (1971). *Elementary survey analysis*. Englewood, NJ: Prentice Hall.



- DeAngelo, L., Franke, R., Hurdado, S., Pryor, J. H., & Tran, S. (2011). *Completing college: Assessing graduation rates at four-year institutions*. Los Angeles, CA: Higher Education Research Institute, UCLA.
- Dobrin, I. (2015, December 5). Within five years, UA officials want 70 percent graduation rate. *Razorback Reporter*. Retrieved from [http://\[Mascotreporter.\[host name\].edu/2015/12/within-5-years-uark-officials-want-70-percent-graduation-rate](http://[Mascotreporter.[host name].edu/2015/12/within-5-years-uark-officials-want-70-percent-graduation-rate)
- Edgar, L. D., Whitehead, I., & Davis, K. J. (2017). College of agriculture honors students' needs: Developing a process for faculty change to enhance student success. Oral presentation at the *NACTA Conference*, West Lafayette, Indiana (June 28-July 1, 2017). Proceedings available at [https://www.nactateachers.org/images/website/2017\\_Purdue/2017\\_NACTA\\_Program.pdf](https://www.nactateachers.org/images/website/2017_Purdue/2017_NACTA_Program.pdf)
- Field, A., Miles, J., & Field, Z. (2012). *Discovering statistics using R*. Thousand Oaks, CA: Sage Publications.
- Hale, M. D., Graham, D. L., & Johnson, D. M. (2009). Are students more satisfied with academic advising when there is congruence between actual and preferred advising styles? *College Student Journal*, *43*(2), 313-324.
- Lani, J. (2014). Assumptions of logistic regression. Retrieved June 5, 2015 <https://www.statisticssolutions.com/assumptions-of-logistic-regression>
- Mau, W. C. (2016). Characteristics of US students that pursued a STEM major and factors that predicted their persistence in degree completion. *Universal Journal of Educational Research*, *4*(6), 1495-1500. doi: 10.13189/ujer.0406.30
- National Research Council (NRC). (2009). *Transforming agricultural education for a changing world*. Washington, DC: National Academies Press.
- Osborne, J. W. (2015). *Best practices in logistic regression*. Thousand Oaks, CA: Sage Publications.
- Peng, C-Y. J., Lee, K. L., & Ingersoll, G. M. (2002). An introduction to logistic regression analysis and reporting. *The Journal of Educational Research*, *96*(1), 3-14.
- Pike, G. R., Hansen, M. J., & Childress, J. E. (2013). The influence of students' pre-college characteristics, high school experiences, college expectations, and initial enrollment characteristics on degree attainment. *Journal College Student Retention*, *16*(1), 1-23. doi: 10.2190/CS.16.1.a
- Roberts, T. G., Harder, A., & Brashears, M. T. (Eds.) 2016. *American Association for Agricultural Education national research agenda: 2016-2020*. Gainesville, FL: Department of Agricultural Education and Communication.

- Shoulders, C. W., & Myers, B. E. (2011). Considering professional identity to enhance agriculture teacher development. *Journal of Agricultural Education*, 52(4), 98-108. doi: 10.5032/jae.2011.04098
- STEM Food and Ag. Council. (2014). *STEM Annual Report* (No. 1). Retrieved September 19, 2017 from <https://www.stemconnector.com/wp-content/uploads/2016/11/STEM-Food-And-Ag-Annual-2014.pdf>
- Stripling, C. T., & Ricketts, J. C. (2016). Research priority 3: Sufficient scientific and professional workforce that addresses the challenges of the 21st Century. In T. G. Roberts, A. Harder, & T. M. Brashears (Eds.), *American Association for Agricultural Education national research agenda: 2016-2020*. Gainesville, FL: Department of Agricultural Education and Communication.
- Tinto, V. (1975). Dropout form higher education: A theoretical synthesis of recent research. *Review of Educational Research*, 41(1), 89-125.
- Tinto, V. (1993). *Leaving college: Rethinking the causes and cures of student attrition*. (2nd ed.) Chicago, IL: The University of Chicago.
- United States Department of Agriculture (USDA). 2016. Ag and food sectors and the economy. Economic Research Service. Retrieved April 12, 2016 from <http://www.ers.usda.gov/data-products/ag-and-food-statisticscharting-the-essentials/ag-and-food-sectors-and-the-economy.aspx>
- Wohlgemuth, D., Whalen, D., Sullivan, J., Nading, C., Shelley, M., & Wang Y. R. (2007). Financial, academic, and environmental influences on the retention and graduation of students. *Journal College Student Retention*, 8(4), 457-475.

# **Experimental Studies in School-based Agricultural Education from 2006-2016: A Synthesis of the Literature in the Journal of Agricultural Education**

Blake C. Colclasure, University of Florida  
Andrew C. Thoron, University of Florida

## **Abstract**

*The purpose of this synthesis of literature was to identify and analyze existing research that used experimental or quasi-experimental design in school-based agricultural education. This study utilized published articles in the Journal of Agricultural Education from the years 2006 through 2016. The study identified 35 articles that met the criteria of the investigation. Studies were analyzed and compared based on the number of participants and duration of the study. Trends in research constructs were found to be the impact of curriculum design, technology, laboratory approaches, and methods of active learning on student outcomes. Trends in researcher recommendations included extended treatment durations, larger sample sizes, follow-up research addressing long-term knowledge retention, increased teacher training through professional development, and exploring the impact of teaching methodologies and curriculum design on constructs such as student motivation, interest, and self-efficacy.*

## **Introduction**

Education methodologies and curriculum design in America's K-12 school systems continue to experience a state of dynamic change due to the pressure of increased student performance (Hanushek, Peterson, & Woessmann, 2010). Federal and state educational policy, along with local authority, often pursue the goal of meeting America's need for college and career ready students (Darling-Hammond, Wilhoit, & Pittenger, 2014). Mass efforts to quantify students' college and career readiness have led to school accountability through standardized testing, which has strengthened the lens of classroom and teacher accountability (Wang, Beckett, & Brown, 2010). In an era of high-stakes education where classrooms and teachers must demonstrate educational merit, agricultural education programs must be well positioned to justify their worth by measurable student achievement.

Integration of Science, Technology, Engineering, and Math (STEM) education, as well as other core curricula, into agricultural education, is one strategy that has gained traction. In fact, Priority 3 of the 2016-2020 American Association for Agricultural Education (AAAE) National Research Agenda (NRA) proposed the question "What are effective models for STEM integration in school-based agricultural education curriculum?" (Stripling & Ricketts, 2016, p. 31). Although curriculum integration and adoption may be a sensible solution to increased student academic performance in core curricula, some fear that an overemphasis of core curricula in agriculture could undermine student acquisition of agricultural competency and technical skills (Parr, Edwards, & Leising, 2008). The debate of what is to be taught in agricultural education curriculum continues to form as non-traditional agricultural education curriculum emerge to meet the needs of a changing student demographic, teacher demographic, and educational policy reform. Research that investigates the design of specific curriculum on

student performance creates empirical evidence that can guide teaching and learning in agriculture.

Research in school-based agricultural education (SBAE) should critically analyze the curriculum taught and investigate the effectiveness of teaching methods to determine how the content is most effectively taught (Thoron & Myers, 2011a). As curriculum integration continues to expand in SBAE, new methods for teaching these concepts should be analyzed. The 2016-2020 AAAE NRA called for research in examining the effectiveness of instructional strategies currently not highly used in agricultural education, but have served as effective strategies in other disciplines (Roberts, Harder, & Brashears, 2016). According to the National Association of Science (1996), the methodology of teaching science education has shifted from traditional teaching approaches, such as direct instruction, to approaches that favor active learning. Other research in education has praised active learning strategies such as experiential and inquiry-based learning (Deters, 2005; Gass, 2005; Witt, 2010). Furthermore, technology continues to change how curriculum is delivered. The role of technology inclusion in the classroom is continuously expanding as access and money to support the use of technology becomes more readily available (Cuban, Kirkpatrick, & Peck, 2001; United States Department of Education, 2010).

Experimental or quasi-experimental research on the effectiveness of curriculum design and teaching methodology in SBAE programs is vital to establish a wide-body of empirical evidence that can support best teaching and learning practices in modern SBAE (Thoron & Myers, 2011a). In fact, the AAAE NRA proclaimed “utilizing research to draw a connection between the impacts of our academic programs and student preparedness and success is essential for survival and sustainability of agricultural leadership, education, and extension education...” (Stripling & Ricketts, 2016, p. 32). According to Thoron and Myers (2011a), the establishment of a standards-based educational system has produced the need for more experimental research on teaching methods that increase student learning in SBAE. Furthermore, experimental research on teaching methods in agricultural education can promote school administrators to offer professional development opportunities to teachers that are based on best practices. Thoron and Myers (2011a) argued “one challenge is the lack of studies that support specific methodologies” (p. 175). The U.S. Department of Education (2003a; 2003b) has provided research funding to encourage experimental design that utilizes random treatment and control groups. The AAAE NRA also expressed the need for experimental studies that examine student learning outcomes through inquiry-based instruction and STEM-infused agricultural curriculum (Stripling & Ricketts, 2016).

Research in education that employs an experimental or quasi-experimental design seeks to actively test an independent variable (Ary, Jacobs, Sorensen, & Walker, 2014). True experimental designs randomly assign the treatment to each participant, and therefore, maximizes control of extraneous variables and have the greatest internal validity. Rarely is true experimental design feasible in intact classrooms, as it is common for all students in each classroom to be exposed to either the same treatment or the same control. According to Gall, Gall, and Borg (2007), quasi-experimental design can be defined by a study lacking random assignment to groups, but offer other strategies to control extraneous variables. Another design, pre-experimental, often considered as a weak design, does not use randomization of treatment nor controls for extraneous variables (Ary et al., 2014). Typically, research in education uses

quasi-experimental designs, and if employed appropriately, can be just as effective as experimental designs (Rubin, 1974).

Conducting experimental or quasi-experimental research in education can be difficult. Gaining permission from school administration, teachers, parents, and students, as standard procedure required by institutional revenue boards (United States Department of Health and Human Services, 2017), may be challenging. Furthermore, following proper methodology in experimental research may be difficult in live classroom settings. A proper treatment duration is necessary to accurately measure the effects of the treatment (Ary et al., 2014). This factor is especially critical when exposing students to a new teaching method they may not be familiar with (Thoron, 2010) and when measuring complex learning constructs such as critical thinking and problem-solving ability, which take longer to cognitively develop (Thoron & Myers, 2012a). Obtaining and retaining a sufficient sample size that is practically and statistically significant, without finding significance due to an inflated sample size (Hays, 1973), may also be challenging. Previous studies indicated participant mortality rates are often as high as 50% in quasi-experimental designs (Boone, 1988; Dyer, 1995; Flowers, 1986; Myers, 2004). Researchers using experimental and quasi-experimental designs in SBAE must be aware of such challenges and should analyze previous literature to seek practical designs and researcher recommendations (Thoron & Myers, 2011a).

### **Purpose**

Although the need for experimental research in SBAE is well pronounced in literature, an investigation of previous experimental studies and consideration of recommendations is warranted to improve future experimental-based studies in SBAE. An analysis of existing research will determine what has been done to meet this research need, while providing recommendations for future experimental-based research in SBAE. Furthermore, an analysis of the quality of existing experimental research is needed in order to compose the standard of experimental research in the discipline. The purpose of this investigation was to identify and synthesize existing research that used experimental-type designs in SBAE. This study utilized published articles in the *Journal of Agricultural Education* from the years 2006 through 2016. The following research questions guided this study's investigation:

1. How many studies involving experimental or quasi-experimental research in school-based agricultural education were conducted and published?
2. What was the duration of treatment methods implemented in the experimental or quasi-experimental research designs?
3. How many participants were sampled in the experimental or quasi-experimental research designs?
4. What trends in research foci and research results were common in the experimental or quasi-experimental designs?
5. What trends in research recommendations were suggested by authors of experimental or quasi-experimental studies?

### **Methods/Procedures**

This study used a mixed method research synthesis as its design. A mixed method research synthesis allows the researcher to gather a collection of related studies in an effort to provide an effective summary of knowledge regarding a specific topic (Heyvaert, Hannes, & Onghena, 2016). The publications of interest for this research were studies that used experimental or quasi-experimental designs in SBAE. We examined articles published in the premier journal for agricultural education – *Journal of Agricultural Education*.

We limited the literature to include only studies whose subjects included middle-school through high school students (Grades 6 through 12) in SBAE classrooms. Furthermore, the researchers included only literature published from 2006-2016 in the *Journal of Agricultural Education* in an effort to narrow the scope of the study. The researchers looked at all publications from volumes 47 through 57 and included articles that met the following parameters: (a) published in the *Journal of Agricultural Education*; (b) published between 2006 and 2016; (c) utilized experimental or quasi-experimental design; and (d) included subjects in middle school or secondary SBAE programs.

Each publication that met the parameters of this study was investigated and content for each study was organized in a matrix. *Microsoft Excel* ® was used as the recording software to complete a matrix that included the following for each study: (a) the title of the study; (b) the authors of the study; (c) the year of the study; (d) the length of treatment in the study; (e) the number of participants involved in the study; (f) the treatment construct; and (g) the results of the study.

We investigated Question 1 of the study by analyzing the total number of studies that met the research parameters by year. Question 2 was investigated by determining the lengths of the treatments used in the studies. The lengths of treatment used in the studies contained various units ranging from minutes to semesters. In order to compare the varying treatment units between studies, we converted all treatment lengths to 50-minute instructional days. Research Question 3 was investigated by comparing the number of participants which data were obtained for each study. Participants who dropped studies or who did not meet researcher criteria were not included in comparison of the studies. Research Questions 4 and 5 were investigated by coding the research and categorizing the purpose of each study into consistent themes. All coding adhered to transparent and systematic procedures (Noblit & Hare, 1988; Pawson, 2006). The constant comparative method of analysis (Glaser, 1965) was used to identify central themes for research Questions 4 and 5.

## Findings

### **Research Question 1: How many studies involving experimental or quasi-experimental research in school-based agricultural education were conducted and published?**

Research Question 1 sought to determine the number of studies that were published in the *Journal of Agricultural Education* from 2006-2016 on subjects associated with SBAE that used experimental or quasi-experimental design. Six hundred and seventy-six articles were published in the *Journal of Agricultural Education* from 2006 through 2016. Of these articles, 35 met the parameters of being considered an experimental or quasi-experimental design (Ary et al. 2014),

resulting in roughly a 5% publication rate. An average of slightly more than three articles per year were published. The number of publications per year ranged from a low of two in 2007, 2008, 2009, and 2010 to a high of six in 2014. Table 1 displays the number of experimental studies that met the criteria of this study published in the *Journal of Agricultural Education* between 2006 and 2016.

Table 1

*Number of publications in JAE involving experimental studies in school-based agricultural education from 2006-2016 (n=35)*

Year	Number of Publications
2006	3
2007	2
2008	2
2009	2
2010	2
2011	4
2012	4
2013	4
2014	6
2015	3
2016	3
Total	35

**Research Question 2: What was the duration of treatment methods implemented in the experimental or quasi-experimental research designs?**

Research Question 2 sought to determine and compare the duration of treatment methods used in publications that met the criteria for this study. Previous research in education indicated the duration of treatment may impact the significance of results (Hillocks, 1984).

Thirty-two of 35 articles included a specific duration for the length of treatment that was used in the study. However, the units in which the duration of treatment was given varied considerably between studies. Some studies used weeks as an indicator for duration, although other studies used hours or days. In order to better compare treatment duration, the researchers converted units to instructional days, which was established to be 50 minutes. Therefore, a study with a treatment duration of 75 minutes would convert to 1.5 instructional days and a study with a treatment duration of 2 weeks would be convert to 10 instructional days assuming treatments are not given on weekends. Three studies were not included in the comparison of treatment duration. One study contained a treatment duration described as instructional units and could not be accurately converted. Two studies did not include an accurate description of treatment duration.

Nine of the 32 studies had a treatment duration of 5 instructional days or less, followed by six studies that had a duration between 6 to 10 days. Few studies ranged from 11 to 30 instructional days, while a gap existed in which no studies were found to have a treatment

duration between 31 and 50 days. Four studies had a treatment duration that ranged from 56 to 60 instructional days. Three studies used a semester as a unit for treatment duration which was converted to 90 instructional days and three studies used a year-long treatment duration which was converted to 180 instructional days. The average study was slightly longer than 40 instructional days. Table 2 displays the number of studies by treatment duration.

Table 2

*The number of experimental studies by treatment duration described by instructional days (50-minutes) (n=32)*

Instructional Days	Number of Studies
1-5	9
6-10	6
11-15	1
16-20	2
21-25	2
26-30	1
31-35	0
36-40	0
41-45	0
46-50	0
51-55	1
56-60	4
~90	3
~180	3
Total	32

*\*Note: Three studies were omitted due to unclear treatment duration.*

### **Research Question 3: How many participants were sampled in the experimental or quasi-experimental research designs?**

Research Question 3 sought to determine and compare the number of participants sampled in research designs included in this study. According to Olejnik (1984), the four factors that should be taken into consideration when determining sample size in educational research are: criterion for statistical significance, level of statistical power, statistical analysis strategy, and the size of an effect judged to be meaningful. It was assumed that appropriate procedures for determining sample size were followed by the studies included in this review of literature given all published articles were peer-reviewed and deemed acceptable for publication in the *Journal of Agricultural Education*.

Thirty-four of the 35 studies analyzed in this review included the number of student participants in which data were collected. One study utilized mean data from intact classrooms in the study, therefore, an assumption on the total number of participants could not be made. The number of participants in the studies ranged from 33 to 672. Nine studies had a range of participants from 51 to 100. Ten studies had a range of participants from 101 to 200 and six



studies included between 401 and 450 participants. The mean number of participants was roughly 223 students ( $SD=166.5$ ); however, it was common for larger studies to include multiple publications from varying areas of research within the study, accounting for an inflated mean. Table 3 displays the number of studies by the sample size of each study.

Table 3

*The number of studies by the sample size of the study*

Number of participants	Number of Studies
0-50	2
51-100	9
101-150	5
151-200	5
201-250	0
251-300	3
301-350	0
351-400	2
401-450	6
451-500	1
>500	1
Total	34

*\* Note: One study was excluded as the number of student participants was not reported.*

#### **Research Question 4: What trends in research foci and research results were common in the experimental or quasi-experimental designs?**

Research Question 4 sought to establish trends in areas of investigation for the research areas published. Furthermore, research Question 4 required results from areas of similar investigations to be synthesized. Through coding each study's primary area of investigation, several trends in research emphasis were revealed: (a) studies that investigated curriculum; (b) studies that investigated the use of technology; (c) studies that investigated laboratory approaches; and (d) studies that investigated a method of active learning.

Results indicated the area of investigation for 14 studies involved curriculum. Six studies investigated the effect of a new curriculum on student outcomes. Examples of studies focused on new curriculum efforts include: Rusk, Brubaker, Balschweid, and Pajor, (2006); Salle, Edgar, and Johnson, (2013); Sapp and Thoron, (2014); Schafbuch, Vicent, Mazur, Watson, and Westneat, (2016); Skelton, Stair, Dormody, and Vanleeuwen, (2014); and Wagler et al., (2008). The inclusion of new curriculum involving farm safety (Schafbuch et al., 2016), biodiesel (Salle et al., 2013), swine (Wagler et al., 2008), and livestock ethics (Rusk et al, 2006) all increased student knowledge in learning constructs measured. Four studies investigated the enhancement of existing agriculture curriculum with math (Edwards & Leising, 2009; Parr, Edwards, & Leising, 2008; Parr, Edwards, & Leising, 2006; Young, Edwards, & Leising, 2009). As a component of a large study on math-enhanced curriculum, Parr et al. (2006) found math-enhanced Agricultural Power and Technology curriculum increased student performance on

mathematics placement tests. However, Edwards and Leising (2009) found a change in students' mathematical ability to solve workplace problems after exposure to math-enhanced agriculture curriculum was not significant. Furthermore, Parr et al. (2008) found the math-enhanced curriculum did not lower students' technical competence.

Two studies investigated science-enhanced curriculum (Haynes & Robinson, 2012; Pearson, Young, & Richardson, 2013). In a one-semester pilot study, Pearson et al. (2013) partnered SBAE teachers and science teachers to create and teach students context-based agriculture lessons. Compared to a control group, post-test scores indicated students who experienced a science-enhanced curriculum demonstrated significant positive achievement in science scores with the exception of the bottom scoring quartile. In a shorter casual comparative study, Hayes and Robinson (2012) found students exposed to a science-enhanced, CAERT curriculum did not perform significantly better on a science proficiency exam compared to a comparison group. In another study addressing science curriculum, Shoulders and Myers (2013) found students exposed to 6 weeks of socioscientific issues-based instruction increased content knowledge scores from pretest to posttest both proximally and distally.

Three quasi-experimental studies examined technology integration on student performance (Bunch, Robinson, Edwards, & Antonenko, 2014; Conoley, Croom, Moore, & Flowers, 2007; Pense, Calvin, Watson, & Wakefield, 2012). Bunch et al. (2014) did not find a significant effect on student achievement in mathematics or agriculture when students were exposed to digital game-based learning over traditional direct instruction. However, Pense et al. (2012) found traditional students and students with learning disabilities exposed to interactive web-based tools increased achievement. In another experimental study, Conoley et al. (2007) found that electronic audience response systems increase student achievement.

Three studies analyzed formative assessment strategies in laboratory settings (Thoron & Myers, 2010; Thoron & Myers, 2011b; Thoron & Rubenstein, 2013). These studies compared the effect of using Vee maps with standard laboratory reports on student outcomes. Vee maps are designed to encourage students to form their own investigations by creating an inquiry question, developing a list of key words, creating a graphic organizer and lab procedure, performing research to collect data, and writing report conclusions. Experimental studies on using Vee maps compared to standard laboratory reports conclude that students gain more content knowledge and increase high-order thinking skills (Thoron & Myers, 2010; Thoron & Rubenstein, 2013). Furthermore, research indicated the use of Vee maps is unbiased based on gender, grade, and ethnicity (Thoron & Myers, 2011b).

Lastly 11 studies were found that investigated active learning methodologies on student performance. Myers and Dyer (2006) investigated laboratory integration using three levels of treatment: (a) subject matter approach without laboratory experimentation; (b) subject matter approach with investigative laboratory experimentation; and (c) subject matter approach with prescriptive laboratory experimentation. Findings indicated that students taught using the subject matter approach with investigative laboratory experimentation scored higher on content knowledge and science process skills compared to students using the subject matter approach with prescriptive laboratory experimentation. In a study exposing 200 students to 9, 50-minute lessons utilizing either active learning strategies or passive learning strategies, students exposed

to active learning strategies had higher positive perceptions of the teaching method compared to students exposed to passive learning (Mueller, Knobloch, & Orvis, 2015).

Two studies examined experiential learning on student outcomes. In a study involving wind energy curriculum, Baker and Robinson (2016) assigned 80 students to either a four-hour lesson using direct instruction or a four-hour lesson using experiential learning. They found students who were assigned to the experiential learning method scored higher on creativity scores and practical use of knowledge scores.

Six studies researched the effects of inquiry-based instruction. A large study by Thoron and Myers (2011) compared the use of inquiry-based instruction to the subject matter approach on student content knowledge achievement. The 12-week study incorporated seven different secondary schools across the U.S. and included 437 students. Seven units of instruction were taught using either the treatment or control. A pretest was given to students before each unit and a posttest was given after each unit. Findings indicated students who received inquiry-based instruction had higher content knowledge achievement compared to students taught through the subject matter approach. Further research from this study concluded students taught through inquiry-based learning also scored higher in argumentation skills and in scientific reasoning (Thoron & Myers, 2012a; Thoron & Myers, 2012b). Data from this study illustrated that inquiry-based instruction did not affect the knowledge retention levels of students with special needs (Easterly & Myers, 2011). In a 12-week study involving 170 students, Thoron and Burleson (2014) investigated student perceptions when taught through inquiry-based learning. The study administered 21 questions on a Likert-type scale that evaluated students' attitudes towards agriscience and students' attitudes towards inquiry-based instruction.

### **Research Question 5: What trends in research recommendations were suggested by authors of experimental or quasi-experimental studies?**

Research Question 5 sought to synthesize researcher recommendation involving future studies. Through coding the recommendations section of each publication, five common themes in research recommendations were found: (a) future experimental studies should extend treatment duration; (b) future experimental studies should include larger sample sizes; (c) future experimental studies should address students' long-term outcomes; (d) professional development should be utilized to ensure instructors deliver treatment appropriately; and (e) future studies in teaching methodologies and curriculum design should investigate student motivation, interest, and self-efficacy.

Many studies concluded the duration in which the treatment was conducted may not have been long enough to properly impact student variables. Therefore, several studies included this issue as a limiting factor. Although increasing duration of experimental studies could lead to more significant results, longer treatment durations may come at a cost. Teachers who often implement experimental studies in their classroom may be weary to commit to large time commitments longer-term studies bring. Furthermore, longer studies may increase mortality rates that could interfere with statistical significance. Seven studies suggested follow-up research using experimental design extend the duration of the treatment (Baker et al., 2014; Baker & Robinson, 2016; Bunch et al., 2014; Burris & Garton, 2007; Parr et al., 2009; Pennington et al., 2015; Rose et al., 2015).

Several studies included a small sample size as a limiting factor to their research design. Larger sample sizes may increase statistical power and include a more representative sample of the student body in agricultural education. It should also be noted, however, larger sample sizes can increase research cost and effort. Furthermore, larger sample sizes may require more schools and teachers which can unintentionally cause an increase in treatment variability, yet it may offset student and teacher fatigue (Shoulders & Myers, 2013). Eight studies recommended future research increase the sample size used in the experimental design (Baker et al., 2014; Blackburn & Robinson, 2016; Bunch et al., 2014; Easterly & Myers, 2011; Morgan et al., 2016; Rose et al., 2015; Sapp & Thoron, 2014; Witt et al., 2014).

Six studies recommended future research in experimental design investigate long-term knowledge retention of subjects exposed to treatments (Baker et al., 2014; Bunch et al., 2014; Myers & Dyer, 2006; Pennington et al., 2015; Sapp & Thoron, 2014; Wagler, et al., 2008). Retention of desired student outcomes and student long-term knowledge gains are often the goal of education. A deferred post-test, a post post-test, or a follow-up study using qualitative design could determine if differences in student outcomes are held long-term.

Several studies cited treatment methods may not have been delivered appropriately due to poor teacher knowledge of instructional methodology used in the study. In order to combat this issue, four studies recommended that adequate professional development opportunities be held for classroom teachers who are implementing instructional methodology (Haynes et al., 2012; Johnson & Roberts, 2011; Morgan et al., 2016; Thoron & Burlison, 2014). Professional development provided to teachers will make the implementation of the research design more effective, and could positively impact teachers and students in ways not associated with the study.

Lastly, future research recommendations called for more experimental studies involving the impact of curriculum design and teaching methods on other factors besides academic achievement. Witt et al. (2014) recommended future experimental research in cognitive behavior and student engagement. Sapp & Thoron (2014) recommended additional studies that determine the effects of teaching methods on students' attitudes toward subject matter and teaching approaches. Other recommendations included additional experimental studies on student motivation, interest, and self-efficacy (Baker & Robinson, 2016; Pense et al., 2010; Salle et al., 2013; Thoron & Myers, 2012).

### **Conclusions & Recommendations**

A total of 35 experimental or quasi-experimental studies within SBAE were published in the *Journal of Agricultural Education* between 2006 and 2016, indicating roughly a 5% publication rate. This number seems alarmingly low considering the need for experimental-based research in SBAE. Are researchers not conducting experimental-based studies in SBAE or are such studies not being accepted for publication? It is recommended the profession employ a rejuvenated commitment toward conducting and publishing quality experimental research in SBAE.

Findings indicated a majority ( $n=21$ ) of studies included a treatment duration of less than 30 instructional days, with nine studies being less than 5 days in length. It is recommended that caution be given to results of studies that utilize short treatment durations, especially when measuring learning constructs that take time to develop (Ary et al., 2014). Eleven studies were longer than 50 instructional days. Most studies had between 50 and 200 participants with only two studies having less than 50 participants and one study having more than 500.

Trends in research focus included the impact of curriculum design, technology, laboratory approaches, and methods of active learning. Studies suggested future research in experimental design in SBAE include extended study durations, larger sample sizes, follow-up research addressing long-term knowledge retention, increased teacher training through professional development, and exploring the impact of teaching methodologies and curriculum design on constructs such as student motivation, interest, and self-efficacy.

There are several limitations to this synthesis of literature. Research assumptions were made when analyzing data for this study. We had to make assumptions regarding varying units of duration for treatments in order for studies to be fairly compared. Converting units such as weeks of instruction to 50-minute instructional days yields a chance of researcher error. Furthermore, several of the publications included in this study were part of large studies. We assumed each published article was an independent study and, therefore, depending on interpretation, averages for concepts such as treatment duration and number of participants could be significantly skewed. Incomplete data from some studies could have affected the analysis for this research.

It is recommended that further investigation on experimental studies in SBAE continue beyond the *Journal of Agricultural Education*. This report did not analyze the statistical significance of findings found in studies or if studies followed proper research design and reliable instrumentation. Measures such as comparing effect size could increase the rigor of future synthesis of literature in experimental education (Abrami & Bernard, 2007). Future experimental research in SBAE should include random selection and true experimental design whenever possible (Blackburn & Robinson, 2016; Pearson et al., 2013; Haynes et al., 2012). Future quasi-experimental research should also make every effort to use best practices in educational research. Lastly, researchers must fully question if the quality and number of published experimental-based research studies in SBAE are adequately meeting the needs of the profession as discussed in the National Research Agenda.

## References

- Abrami, P. C., & Bernard, R. M. (2007). *Statistical control vs. classification of study in meta-analysis*. Manuscript submitted for publication.
- Ary, D., Jacobs, L. C., Sorensen, C. K., & Walker, D. A. (2014). *Introduction to research in education*. (9<sup>th</sup> Edition). Belmont, CA: Wadsworth, Cengage Learning.
- Baker, M. A., Brown, N. R., Blackburn, J. J., & Robinson, J. S. (2014). Determining the effects that the order of abstraction and type of reflection have on content knowledge when teaching experientially: An exploratory experiment. *Journal of Agricultural Education*, 55(2), 106-119. doi: 10.5032/jae.2014.02106
- Baker, M. A., & Robinson, J. S. (2016). The effects of Kolb's experiential learning model on successful intelligence in secondary agriculture students. *Journal of Agricultural Education*, 57(3), 129-144. doi: 10.5032/jae.2016.03129
- Blackburn, J. J., & Robinson, J. S. (2016). Determining the effect of cognitive style, problem complexity, and hypothesis generation on the problem solving ability of school-based agricultural education students. *Journal of Agricultural Education*, 57(2), 46-59. doi: 10.5032/jae.2016.02046
- Boone, H. N., Jr. (1988). *Effects of approach to teaching on student achievement retention, and attitude*. Unpublished dissertation, The Ohio State University, Columbus.
- Bunch, J. C., Robinson, J. S., Edwards, M. C., & Antonenko, P. D. (2014). How a serious digital game affected students' animal science and mathematical competence in agricultural education. *Journal of Agricultural Education*, 55(3), 57-71. doi: 10.5032/jae.2014.03057
- Burris, S., & Garton, B. L. (2007). Effects of instructional strategy on critical thinking and content knowledge: Using problem-based learning in the secondary classroom. *Journal of Agricultural Education*, 48(1), 106-116. doi: 10.5032/jae.2007.01106
- Conoley, J. W., Croom, D. B., Moore, G. E., & Flowers, J. L. (2007). Using electronic audience response systems in a high school agriscience courses. *Journal of Agricultural Education*, 48(3), 67-77. doi: 10.5032/jae.2007.03067
- Cuban, L., Kirkpatrick, H., & Peck, C. (2001). High access and low use of technologies in high school classrooms: Explaining an apparent paradox. *American Educational Research Journal*, 38(4), 813-834. doi:10.3102/00028312038004813
- Darling-Hammond, L., Wilhoit, G., & Pittenger, L. (2014). Accountability for college and career readiness: Developing a new paradigm. *Education Policy Analysis Archives*, 22(86), 1-38. doi: 10.14507/epaa.v22n86.2014
- Deters, K. M. (2005). Student opinions regarding inquiry-based labs. *Journal of Chemical Education*, 82(8), 1178-1180. Retrieved from [www.jce.divched.org](http://www.jce.divched.org)

- Dyer, J. E. (1995). *Effects of teaching approach on achievement, retention, and problem solving ability of Illinois agricultural education students with varying learning styles*. Unpublished doctoral dissertation, University of Illinois at Urbana-Champaign.
- Easterly III, R. G., & Myers, B. E. (2011). Inquiry-based instruction for students with special needs in school based agricultural education. *Journal of Agricultural Education*, 52(2), 36-46. doi: 10.5032/jae.2011.02036
- Edwards, M. C., & Leising, J. G. (2009). Selected effects of a curriculum integration intervention on the mathematics performance of secondary students enrolled in an agricultural power and technology course: An experimental study. *Journal of Agricultural Education*, 50(1), 57-69. doi: 10.5032/jae.2009.01057
- Flowers, J. L. (1986). *Effects of problem solving approach on achievement, retention, and attitudes of vocational agriculture students in Illinois*. Unpublished doctoral dissertation, University of Illinois at Urbana Champaign.
- Gall, M. D., Gall, J. P., & Borg, W. R. (2007). *Educational research: An introduction*. Boston, MA: Pearson Education.
- Gass, M. A. (2005). Comprehending the value structures influence significant and power behind experiential education research. *The Journal of Experiential Education*, 27(3), 286-296.
- Glaser, B. G. (1965). The constant comparative method of qualitative analysis. *Social Problems*, 12(4), 436-445. Retrieved from <http://www.sssp1.org/index.cfm/m/325>
- Hanushek, E. A., Peterson, P. E., & Woessmann, L. (2010). *U.S. math performance in global perspectives: How well does each state do at producing high-achieving students?* (PEPG Report No.:10-19). Retrieved from [hks.harvard.edu/pepg](http://hks.harvard.edu/pepg)
- Harris, C. J., & Rooks, D. L. (2010). Managing inquiry-based science: Challenges in enacting complex science instruction in elementary and middle school classrooms. *Journal of Science Teacher Education*, 21(2), 227-240. doi: 10.1007/s10972-009-9172-5
- Hays, W. L. (1973). *Statistics for the social sciences*. New York: Holt, Rinehart, and Winston.
- Haynes, J. C., Robinson, J. S., & Key, J. P. (2012). Assessing the effect of using a science-enhanced curriculum to improve agriculture students' science scores: A casual comparative study. *Journal of Agricultural Education*, 53(2), 15-27. doi: 10.5032/jae.2012.0215
- Herman, J. L., & Winters, L. (1992). *Tracking your school's success: A guide to sensible evaluation*. Thousand Oaks, CA: Corwin Press.

- Heyvaert, M., Hannes, K., & Onghena, P. (2016). *Using mixed methods research synthesis for literature reviews: The mixed methods research synthesis approach*. Thousand Oaks, CA: SAGE
- Hillcocks, G. (1984). What works in teaching composition: A meta-analysis of experimental treatment studies. *American Journal of Education*, 93(1), 133-170.
- Johnson, T. L., & Roberts, T. G. (2011). The effect of an interest approach on knowledge, attitudes, and engagement of high school agricultural science students. *Journal of Agricultural Education*, 52(1), 143-154. doi: 10.5032/jae.2011.01143
- Mueller, A. L., Knobloch, N. A., & Orvis, K. S. (2015). Exploring the effects of active learning on high school students' outcomes and teacher's perceptions of biotechnology and genetics instruction. *Journal of Agricultural Education*, 56(2), 138-152. doi: 10.5032/jae.2015.02138
- Myers, B. E. (2004). *Effects of investigative laboratory integration on student content knowledge and science process skill achievement across learning styles*. Unpublished doctoral dissertation, University of Florida, Gainesville.
- Myers, B. E., & Dyer, J. E. (2006). Effects of investigative laboratory instruction on content knowledge and science process skill achievement across learning styles. *Journal of Agricultural Education*, 47(4), 52-63. doi: 10.5032/jae.2006.04052
- National Academy of Science. (1996). *National science education standards*. Washington, DC: National Academy Press.
- Noblit, G., & Hare, R. D. (1988). *Meta-ethnography: Synthesizing qualitative studies*. Newbury Park, Ca: SAGE
- Olejnik, S. F. (2002). Planning educational research: Determining the necessary sample size. *The Journal of Experimental Education*, 53(1), 40-48.
- Parr, B. A., Edwards, M. C., & Leising, J. G. (2006). Effects of a math-enhanced curriculum and instructional approach on the mathematics achievement of agricultural power and technology students: An experimental study. *Journal of Agricultural Education*, 47(3), 81-93. doi: 10.5032/jae.2006.03081
- Parr, B. A., Edwards, M. C., & Leising, J. G. (2008). Does a curriculum integration intervention to improve the mathematical achievement of students diminish their acquisition of technical competence? An experimental study in agricultural mechanics. *Journal of Agricultural Education*, 49(1), 61-71. doi: 10.5032/jae.2008.01061
- Pawson, R. (2006). *Evidence-based policy: A realist perspective*. Thousand Oaks, CA: SAGE
- Pearson, D., Young, R. B., & Richardson, G. B. (2013). Exploring the technical expression of



- academic knowledge: The science-in-CTE pilot study. *Journal of Agricultural Education*, 54(4), 162-179. doi: 10.5032/jae.2013.04162
- Pennington, K., Calico, C., Edgar, L. D., Edgar, D. W., & Johnson, D. M. (2015). Knowledge and perceptions of visual communications curriculum in Arkansas secondary agricultural classrooms: A closer look at experiential learning integrations. *Journal of Agricultural Education*, 56(2), 27-42. doi: 10.5032/jae.2015.02027
- Pense, S. L., Calvin, J., Watson, D. G., & Wakefield, D. B. (2012). Incorporating learning objectives in a curriculum redesign to meet needs of students with specific learning disabilities in Illinois agricultural education programs. *Journal of Agricultural Education*, 53(4), 112-123. doi: 10.5032/jae.2012.04112
- Pense, S. L., Watson, D. G., & Wakefield, D. B. (2010). Learning disabled student needs met through curriculum redesign of the Illinois agricultural education core curriculum. *Journal of Agricultural Education*, 51(2), 115-126. doi: 10.5032/jae.2010.02115
- Roberts, T. G., Harder, A., & Brashears, M. T. (Eds). (2016). *American Association for Agricultural Education national research agenda: 2016-2020*. Gainesville, FL: Department of Agricultural Education and Communication.
- Rose, M., Pate, M. L., Lawver, R. G. Warnick, B. K., & Dai, X. (2015). Assessing the impact of sequencing practicums for welding in agricultural mechanics. *Journal of Agricultural Education*, 56(1), 92-102. doi: 10.5032/jae.2015.01092
- Rubin, D. B. (1974). Estimating causal effects of treatments in randomized and nonrandomized studies. *Journal of Educational Psychology*, 66(5), 688-701.
- Rusk, C. P., Brubaker, K. M., Balschweid, M. A., & Pajor, E. A. (2006). Evaluation of a livestock ethics curriculum for high school youth. *Journal of Agricultural Education*, 47(3), 105-116. doi: 10.5032/jae.2006.03105
- Salle, C. W., Edgar, D. W., & Johnson, D. M. (2013). Student perceptions of instructional methods towards alternative energy education. *Journal of Agricultural Education*, 54(2), 130-142. doi: 10.5032/jae.2013.02130
- Sapp, S. B., & Thoron, A. C. (2014). Effects of agricultural sales CDE modules on content knowledge and argumentation skill. *Journal of Agricultural Education*, 55(5), 93-110. doi: 10.5032/jae.2014.05093
- Schafbuch, M. L., Vincent, S. K., Mazur, J., Watson, J. & Westneat, S. (2016). The CROPS curriculum experiment: Evaluating the farm safety knowledge gained among secondary Appalachia youth. *Journal of Agricultural Education*, 57(2), 134-145. doi: 10.5032/jae.2016.02134
- Shoulders, C. W., & Myers, B. E. (2013). Socioscientific issues-based instruction: An

- investigation of agriscience students' content knowledge based on student variables. *Journal of Agricultural Education*, 54(3), 140-156. doi: 10.5032/jae.2013.03140
- Skelton, P., Stair, K. S., Dormody, T., & Vanleeuwen, D. (2014). Determining the science, agriculture and natural resource, and youth leadership outcomes for students participating in an innovative middle school agriscience program. *Journal of Agricultural Education*, 55(4), 53-71. doi: 10.5032/jae.2014.04053
- Stripling, C. T., & Ricketts, J. C. (2016). Research priority 3: sufficient scientific and professional workforce that addresses the challenges of the 21<sup>st</sup> century. In T. G. Roberts, A. Harder, & M. T. Brashears (Eds.), *American Association for Agricultural Education national research agenda: 2016-2020*. Gainesville, FL: Department of Agricultural Education and Communication.
- Thoron, A. C. (2010). *Effects of inquiry-based agriscience instruction on student argumentation skills, scientific reasoning, and student achievement* (Doctoral dissertation). University of Florida, Gainesville, FL.
- Thoron, A. C., & Burleson, S. E. (2014). Student's perceptions of agriscience when taught through inquiry-based instruction. *Journal of Agricultural Education*, 55(1), 66-75. doi:10.5032/jae.2014.01066
- Thoron, A. C., & Myers, B. E. (2010). The effect of using vee maps versus standard laboratory reports on achieving student content knowledge. *Journal of Agricultural Education*, 51(3), 12-22. doi: 10.5032/jae.2010.03012
- Thoron, A. C., & Myers, B. E. (2011a). Effects of inquiry-based agriscience instruction on student achievement. *Journal of Agricultural Education*, 52(4), 175-187. doi: 10.5032/jae.2011.04175
- Thoron, A. C. & Myers, B. E. (2011b). Impact of gender, ethnicity, year in school, social economic status, and state standardized assessment scores on student content knowledge achievement when using vee maps as a formative assessment tool. *Journal of Agricultural Education*, 52(1), 85-95. doi: 10.5032/jae.2011.01085
- Thoron, A. C., & Myers, B. E. (2012a). Effects of inquiry-based agriscience instruction on student scientific reasoning. *Journal of Agricultural Education*, 53(4), 156-170. doi: 10.5032/jae.2012.04156
- Thoron, A. C., & Myers, B. E. (2012b). Effects of inquiry-based agriscience instruction and subject matter-based instruction on student argumentation skills. *Journal of Agricultural Education*, 53(2), 58-69. doi: 10.5032/jae.2012.02058
- Thoron, A. C., & Rubenstein, E. D. (2013). The effect of vee maps and laboratory reports on high- and low-order content knowledge achievement in agriscience education. *Journal of Agricultural Education*, 54(3), 198-208. doi: 10.5032/jae.2013.03198

- U.S. Department of Education. (2003a, November 4). Scientifically-based evaluation methods. *Federal Register*, 68(213), pp. 62445-62447
- U.S. Department of Education. (2003b, December). *Identifying and implementing educational practices supported by rigorous evidence: A user friendly guide*. Washington, DC: Author.
- U.S. Department of Education, Office of Educational Technology. (2010). *Transforming American Education: Learning Powered by Technology*. Washington, D.C.: U.S. Government Printing Office
- U.S. Department of Health and Human Services. (2017). Institutional review boards frequently asked questions – informational sheet. Retrieved from [www.fda.gov/regulatoryinformation/guidances/ucm126420.htm](http://www.fda.gov/regulatoryinformation/guidances/ucm126420.htm)
- Wagler, S., Rusk, C. P., Blomeke, C. R., Richert, B. T., Latour, M. A., Talbert, B. A. (2008). Classroom evaluation of an elementary educational swine curriculum: There's a pig in my classroom. *Journal of Agricultural Education*, 49(3), 87-98. doi: 10.5032/jae.2008.03087
- Wang, L., Beckett, G. H., & Brown, L. (2006). Controversies of standardized assessment in school accountability reform: A critical synthesis of multidisciplinary research evidence. *Applied Measurement in Education*, 19(4), 305-328. doi: 10.1207/s15324818ame1904\_5
- Witt, P. A., Ulmer, J. D., Burris, S., Brashears, T., & Burley, H. (2014). A comparison of student engaged time in agricultural instruction. *Journal of Agricultural Education*, 55(2), 16-32. doi: 10.5032/jae.2014.02016
- Young, R. B., Edwards, M. C., & Leising, J. G. (2009). Does a math-enhanced curriculum and instructional approach diminish student's attainment of technical skills? A year-long experimental study in agricultural power and technology. *Journal of Agricultural Education*, 50(1), 116-126. doi: 10.5032/jae.2009.01116

## **Evaluating the VALOR Program: Blogs as a Reflection Process**

Sarah A. Bush, Virginia Tech  
Chelsea Corkins, Virginia Tech  
Megan Seibel, Virginia Tech  
Jeremy Elliott-Engel, Virginia Tech

### **Abstract**

Leadership inquiry lacks robust studies designed to understand processes as opposed to outcomes. This qualitative case study explored the process of reflection through blogs to evaluate the Virginia Agriculture Leaders Obtaining Results (VALOR) program. We open-coded blog entries for reflection on capacity building and competency development through experiences within the program. Expanded thinking, competency development, and interconnectedness emerged as themes through a collaborative process. Additionally, we identified four subthemes within the themes: change, self-awareness, networking, and affiliations. The majority of intended VALOR program outcomes were readily discussed within emergent themes and the reflection process. The findings within this study support transformative learning and communities of practice as pathways for increasing knowledge and capacity to become change agents. Focusing on increasing opportunities for participants to explore applications of newly created knowledge, can benefit the program and overall development of participants and their communities.

### **Introduction**

It is essential to produce agricultural leaders fully equipped with the competencies and capacity necessary to address 21<sup>st</sup> century challenges (Kaufman, Rateau, Carter, & Strickland, 2012). One current pathway for building these leaders is through adult leadership development programs. Thousands of adult leadership development programs exist within the United States today. These programs vary in goals, specializations, length of program, outcomes, etc., but all share a common focus of creating capable leaders.

The definition for leadership can be a bit ambiguous. A traditional definition states leadership is “a process whereby an individual influences a group of individuals to achieve a common goal” (Northouse, 2013, p. 3). Hanks et al. (2015) refers to leadership as “the collective interactions that inspire others to dream, learn, do, and become more” (p. 1). This definition was developed from a quote attributed to John Quincy Adams (Williams, 2002). These definitions differ, but both are based on the premise that leadership development extends throughout one’s lifespan. Leadership development can be viewed as a continuous learning process, which is built upon knowledge and experience for advancing capacities (Brungardt, 1997). Leadership development is contextual with learning being unique to every opportunity and the specific program (Allen & Hartman, 2008). Understanding the process for this development, including emotions, thoughts, reactions, and embodied cognitions, is essential to truly understanding how to maximize leadership development opportunities and behavioral outcomes (Dinh et al., 2014).

Dinh et al. (2014) postulate understanding leadership processes as the key to expanding ideas and knowledge regarding current theories. Exploration of these processes can be conducted

through evaluation studies, which examine the process in relation to outcomes, rather than just focused on the achievement of outcomes. For agricultural leadership development programs situated within Cooperative Extension, it is essential to conduct rigorous outcome-based evaluations to provide data to demonstrate program value and article outcomes for continued funding (e.g. Black & Earnest, 2009; Lamm, Carter, Lamm, 2016; McClure, Fuhrman, & Morgan, 2012). However, evaluations, which are suitable for the program, need to be developed to explore the process of development that culminates in the achievement of specific outcomes (Black & Earnest, 2009; Gardner, Lowe, Moss, Mahoney, & Cogliser, 2010). This type of evaluation provides a novel understanding of leadership development and meaningful findings for continued program improvement and the development of programs focused on specific clientele.

Reflection is a process of leadership development, which can be evaluated in relation to program outcomes. Harvey and Jenkins (2014) present a tripartite learning model for leadership, including: knowledge, praxis, and reflection. They defined reflection as “an iterative process for returning to what one has studied, thought, experienced, done, and felt, and an autonomous but still relatively structured and disciplined process of synthesizing lessons, conclusions, uncertainties, and questions” (Harvey & Jenkins, 2014, p. 79). Group and individual reflection, such as journaling, are often activities employed within leadership development programs to challenge participants to focus on their experiences (Allen & Hartman, 2008).

Evaluating the reflective process is difficult and challenging because it is an internal process. However, synthesized lessons, conclusions, uncertainties, and questions shared during journaling activities provide insight into the results of the process (Harvey & Jenkins, 2014). Within the Virginia Agriculture Leaders Obtaining Results (VALOR) program, blogging is utilized as a tool for fellows to share reflections and experiences from seminars. The term “blog” is an abbreviation for “web log”, a web-based journal (Chu, Chan, & Tiwari, 2012). A blog allows individuals to express themselves and share information through text, pictures, and sound (Brescia & Miller, 2006; Chu et al., 2012). This evaluation utilized blogs from fellows within the VALOR program to examine the phenomenon of reflection and the relation to program outcomes. We designed this evaluation to provide insight into the process of leadership development and development of related competencies and capacity, which meets intended outcomes of the VALOR program.

### **Review of Agricultural Leadership Programs**

As the agricultural industry continues to diversify, community leaders must be prepared and well-versed in agricultural knowledge to deal with community-wide issues (Galloway, 1997). Agricultural leadership development programs are designed to prepare leaders to solve complex problems and approach challenges within the field, including “volatile commodity markets, increased regulatory requirements, agricultural illiteracy, food security issues, changing demographics, natural resource depletion, and economic survival” (Kaufman et al., 2012, p. 123). To effectively develop these programs, practitioners must define the context, develop a conceptual framework, attain required content, incorporate appropriate pedagogy, and create learning outcomes and evaluation methods (Kaufman et al., 2012).

Agricultural leadership programs have existed for over 70 years (Kelsey & Wall, 2003). The Kellogg Farmer Study Program (KFSP) was the first statewide agricultural leadership program established in 1965 at Michigan State University (KARL, 2017; Kaufman & Carter, 2005). Today 40 states within the U.S. and seven other countries have similar programs with a foundation on usage of workshops and travel seminars. These programs are all affiliated with one another through the International Association of Programs for Agricultural Leadership (IAPAL) and aim to provide agricultural leaders with the capacity to act as change agents within the industry (Kaufman et al., 2012).

Fellows within these programs benefit from knowledge gained regarding local, state, regional, national, and international issues impacting the agricultural industry today (Kaufman & Carter, 2005). IAPAL programs frequently provide, “adequate networking opportunities and time for fellows to access information for their communities” (Kelsey & Wall, 2003, p. 43). However, fellows are not always given the opportunity to address needs in their communities and transfer gained knowledge to be effective agents of change (Kaufman & Carter, 2005). Programs need to move past awareness to develop leaders prepared to effectively and positively impact their communities and increase social capital (Horlings & Padt, 2013; Kelsey & Wall, 2003). It is essential for IAPAL programs to uphold their intended purpose and develop leaders prepared to transfer learnt knowledge through praxis and reflection (Harvey & Jenkins, 2008).

## **VALOR Program**

The VALOR program is a two-year long leadership development experience designed for adults in the state of Virginia aiming to develop communication, critical thinking, and problem-solving skills related to the agricultural industry. This program also provides knowledge on global and local agricultural practices, policy, and advocacy efforts. This program is classified as a fellowship, which is “an intense learning experience usually involving a specific topic of interest” (Allen & Hartman, 2008, p. 13). Over two-years, fellows refine their leadership capabilities through a total of 12 seminars with 10 seminars held at various locations across the state of Virginia, one national seminar, and an international tour. Seminar topics cover a broad spectrum of agricultural enterprise and diverse experiences relating to political, economic, and social components. Fellows are asked to complete a blog for each seminar. An overarching aim of the VALOR program is to provide a sustainable future for Virginia’s agricultural community by developing change agents prepared to advocate for the future of agriculture.

**Program outcomes.** The Virginia program is based around the following short-term and long-term objectives:

1. Enhanced awareness, respect, and profitability of Virginia’s diverse agricultural systems;
2. Development of new partnerships and fostering of deeper collaboration across Virginia’s organizations, groups, and sectors;
3. Improved communication and problem-solving ability of Virginia’s agricultural leaders;
4. Increased civic engagement and public affairs involvement for Virginia’s agricultural community.

At the completion of the program, fellows from the inaugural cohort partook in a participatory pathway logic model development session to provide their own insight on learning mechanisms, which led to desired outcomes (Burbaugh, Seibel, & Archibald, 2017). Burbaugh et al. (2017) uncovered eight short-term outcomes, six mid-term outcomes, and seven long-term outcomes as a result of the mapping process. This feedback provided an opportunity to clearly communicate the logic of the program and feedback on program design and implementation processes (Burbaugh et al., 2017).

### **Theoretical Framework**

Leaders and followers' backgrounds and histories impact their self-awareness, approach to understanding one another, and response to experiences (Avolio, 2007). When adults engage in reflective learning, they are able to integrate their new experiences for expansion of skills and tools (Densten & Gray, 2001). A community of practice (CoP) engages members in communal meaning making through a shared commitment of understanding (Eckert, 2006). Often CoPs involve collaborative reflection processes, which result in the capacity to solve problems quickly, transfer best practices, develop professional skills, and help recruit and retain talent (Wenger & Synder, 2000). Reflection and CoPs provide guiding frameworks for exploring social learning through leadership development.

Adults experience transformative learning when a frame of reference is altered based upon reflection and discourse. Within transformative learning, "the process involves transforming frames of reference through critical reflection of assumptions, validating contested beliefs through discourse, taking action on one's reflective insight, and critically assessing it" (Mezirow, 1997, p. 11). One's frame of reference is their assumptions, including associations, concepts, values, feelings, and conditioned responses, on the truths or understanding of the world around them (Mezirow, 1997). A transformative experience involves individual experience, critical reflection, dialogue, holistic orientation, awareness of context, and authentic relationships (Sammut, 2014). To engage in transformative learning and reflective practices, individuals must be open-minded, responsible, and wholehearted (Densten & Gray, 2001). These traits require capacity to reflect and understand how your own experiences provide genuine ways for learning. Leaders must seek out and readily engage in opportunities and with others to expand their thinking to interpret, decide, and behave in ways that are more inclusive (Avolio, 2007; Brookfield, 2016).

CoPs are simple social systems or "groups of people who share a concern, a set of problems, or a passion about a topic, and who deepen their knowledge and expertise in this area by interacting on an ongoing basis" (Wenger, McDermott, & Synder, 2002, p. 4). A CoP exists within a wider framework of thinking attributed to learning as a social process (Wenger, 2010). The domain (shared interest), community (engagement with others), and practice (sharing of ideas) are the three central characteristics required to be a CoP (Wenger, 2011). With a set of communal goals, CoP members create and explore shared knowledge (Holmes & Meyerhoff, 1999; Wenger, 2010). Within a CoP, individuals challenge each other's assumptions, explore shared experiences, and support each other through transformative learning processes.

Blogs provide an opportunity for reflection within an online CoP (Dennen, 2014). Chu et al. (2012) support blogging as an avenue for collaborative learning, reflection, communication, and social support. Within the VALOR program, fellows engage within a CoP encompassed of other and previous fellows. However, this CoP is able to extend to a larger complex social system with others with broader shared interests (Wenger, 2010). Blogging provides fellows with opportunities to be vulnerable through self-reflection and network as advocates within the agricultural industry.

### **Purpose and Research Questions**

The purpose of this qualitative study was to evaluate how fellows in the VALOR program reflect on capacity building and competency development through blog entries. This research aligns with research priority 5 of the American Association for Agricultural Education National Research Agenda, *Efficient and Effective Agricultural Education Programs* (Thoron, Myers, & Barrick, 2016) by evaluating the impact of an agricultural and natural resources leadership development program. This study sought to address the following questions:

RQ 1: How do fellows in the VALOR program reflect in blogs on their experiences within the program?

RQ 2: How do fellows in the VALOR program's blog reflections connect with outcomes of the program?

### **Methods**

The researchers designed a qualitative case study to explore how fellows in the VALOR program reflect on capacity building and competency development through blog entries. The population for this study consisted of fellows in three cohorts of the VALOR program. A stratified, purposive sample was taken from blog entries made by fellows throughout their time within the VALOR program (Ary, Jacobs, & Sorensen, 2010). Three researchers independently, open-coded the sample of blogs. Through a collaborative process, the researchers compared open-codes for inter-coder reliability and developed emergent themes.

The researchers selected a sample from blog entries of all 32 fellows ( $n= 32$ ) from three cohorts within the VALOR program. At the time of data collection, fellows from cohorts one and two had completed the program and cohort three fellows were halfway through the program. In the VALOR program, fellows are asked to complete at least one blog at each seminar over their two years in the program. The program director did not provide guided questions or structure for the blogs, but rather allowed fellows to create blogs based on their own reflections and takeaways from each seminar. Seminars are held bi-monthly for a total of 12 seminars.

The researchers utilized a stratified, purposive sample from the blog entries (Ary et al., 2010). To diversify the experiences and seminar topics being discussed within the blogs, the researchers selected two blogs from each fellow and made a best attempt to select blogs with varying dates throughout the program. It is important to note that all 32 fellows did not complete 12 blog entries, which served as a limitation within the sampling method. The researchers masked selected blogs for identifying information prior to the coding process.



The researchers conducted an iterative process to provide reliability within the coding and meaning making process (Creswell, 2013). Three researchers open-coded the blog entries independently (Strauss & Corbin, 1990). Two of the researchers work closely with the program. Therefore, an external coder served to provide a more objective assessment (Creswell, 2013). Each researcher provided analytical codes for passages, which discussed personal development or built capacity through experiences. After independently coding all blog entries, the three researchers met to discuss codes for inter-coder reliability and to collaboratively examine patterns for emergent themes (Bernard, Wutich, & Ryan, 2016).

This collaborative process included extracting coded passages, compiling codes for each passage from each researcher, and verbally discussing reasoning behind each code. The researchers continued this process until they met saturation and agreed upon meaning. The researchers determined saturation when codes being discussed were no longer revealing new properties or concepts (Creswell, 2013). The researchers then examined the analytical codes for patterns to generate emergent themes and subthemes. The research team compared themes and subthemes to the intended outcomes of the VALOR program established Burbaugh et al. (2017).

## **Limitations**

There were several limitations within this study. The sampling frame served as a limitation because all seminars were not equally represented within the sampling frame based upon fellow entries. The researchers attempted to diversify the represented seminars as much as possible through the data collection process. Additionally, fellows received varying and vague instructions for completing their blog entries. Therefore, some of the blog entries simply included a detail of experience rather than connections of topics and reflection. Several blogs did not yield any coded passages for extraction. The researchers attempted to reduce biases through practice of reflexivity.

**Reflexivity.** Creswell (2013) deemed reflexivity as essential to reveal how one's biases, values, and background may shape the study. To increase trustworthiness, authenticity, and credibility (Creswell & Miller, 2000), it is essential to share the backgrounds and connections to the program of the researchers who coded and made meaning of codes. Two of the researchers worked directly with the program being evaluated. One researcher is the graduate assistant for programming and the other the graduate assistant for evaluation of the VALOR program. Based upon these close ties to the program, the two researchers acknowledged biases for viewing the program through a positive lens. To mitigate these biases, the third researcher, with no direct ties and minimal previous knowledge regarding the program, served as an external researcher. This researcher is a graduate student in agricultural education and was a previous extension agent. Given the collective experiences and backgrounds, the researchers recognized biases for the power of extension work. The researchers employed biases monitoring and reflection throughout the process to reduce the likelihood of impact on the study.

## **Findings**

Three themes, expanded thinking, competency development, and interconnectedness emerged from the meaning making process. Embedded within these themes were four

subthemes: change, self-awareness, networking, and affiliations. Several of the fellows only provided details of their experiences within their blog entries and did not include reflection upon experiences. This resulted in several blog entries having few to no passages extracted for coding.

## **Expanded Thinking**

Often the fellows wrote about experiences, which expanded their knowledge base. At times the fellows explicitly stated a new factoid or piece of knowledge, which they added to their own personal databases. Others described experiences as eye-opening, resulting in continued expansion of their views within the agricultural and natural resource industry. Fellow 17 noted:

As I gazed in amazement at the 20,000 strawberry plants, my first thought was how sore my back would feel after picking strawberries after about 2 hours (and that would only yield a couple gallons). But with the “Pick Your Own” harvest strategy, the end consumer provides the harvest labor while obtaining a hands-on agriculture experience. Brilliant! It was an interesting path (urban traffic, a few subdivisions, etc.) that led us to [Farm]. Our visit offered a great example of how farmers can interface with consumers in an urban setting.

In this passage, the writer expressed how strategies within diverse contexts require different avenues for success. The researchers observed this thought process throughout many of the passages with fellows noting how experiences caused them to reconsider the agricultural industry and led to a further understanding of the diversity within the industry. For example, fellow 1 shared, “it just goes to show that agriculture comes in many different shapes and forms, and we all need to work together to support all of it.” From this mindset, fellows often expressed self-awareness and a consideration for continued change within the industry.

**Self-awareness.** Within this subtheme, some fellows moved beyond expanded thinking and shared how this new-found knowledge impacted their own views of themselves and the world. For example, one fellow discussed how they were challenged to reconsider their own beliefs.

Is the person in the windshield looking back at me being intellectually honest and consistent in the views and beliefs that he holds? Somewhere between the libertarian ideal of nothing and the totalitarian ideal of everything lies the proper role of government. (Fellow 2)

Another mentioned having to think a bit deeper about what you know and think you know, “having grown up [in] the [Area], I thought I was somewhat versed in the Mennonite ways and lifestyle. I guess that is part of growing up, you realize what all you do not know” (Fellow 32). Within this seminar fellows had learned more about the impact of culture on agricultural practices. This fellow believed they had a strong basis for knowledge on Mennonite culture, but was surprised to hear additional information that caused the individual to become more self-aware of their assumptions and perception of the world.

Fellows also expressed self-awareness through a development of purpose and understanding for one’s role as a leader. Fellow 28 wrote:

Be practical. Be a good opponent. Be informed. Never Break a promise. Don’t change horses in the middle of the stream. Learn to evaluate and weigh issues. Don’t

underestimate Legislators. Be understanding. Be friendly. Be reasonable. Be realistic. Be sure of what you ask for, you might just get it!

This fellow synthesized what they learned from a seminar and communicated how this knowledge would impact their own work as an agricultural leader. This quote expresses the need to continually be self-aware to achieve.

**Change.** Fellows often equated expanded thinking to a call for change within practices and views for the future, which generated this subtheme. One fellow spoke about the current challenges facing the industry and an example of a company considering the future through their current practices.

What will be the changes in styles and sizes of companies requiring imports and exports?, what will be the changes in methods of transportation?, what will be the changes in the types or shapes of goods that are moved around, or in the materials themselves? These are complicated questions, but are crucial to understand the ways in which trade will change over the next 5, 10, even 50 years. The [Company] has all this on their mind as they continue growing and moving forward. (Fellow 23)

Another spoke about their own experiences in the program being an avenue for change. This fellow stated, “on a personal level, participation in VALOR program is a step towards diversification and innovation” (Fellow 4). Fellows spoke about the need for continual change through diverse and innovative initiatives, which were focused on the future.

## **Competency Development**

Frequently fellows blogged about their own competency development and how the tools furthered their personal development as a leader and could benefit the industry. Fellow 2 commented on emotional intelligence as a competency for positive engagement:

What became clear was that, if results are to be obtained by leaders of agriculture in Virginia, a conscious awareness and study of EQ during interactions with others – superiors, subordinates, peers, everyone – will increase the likelihood of a positive engagement.

Another wrote about the role of communication and their role as a communicator:

I think this seemed fitting as the seminar was about communication, and we all assumed it was about communicating in our industry, but I also think it was about communicating with the past fellows. One thing we have to remember is to communicate with the people that have done something before, so you can make the most out of what you are doing, and not repeat the same mistakes. (Fellow 1)

Both fellows expressed ways to utilize their competencies to be good stewards of the program and the industry.

## **Interconnectedness**

Within fellows’ blogs, they discussed interconnectedness at length. Many fellows saw VALOR as an opportunity to become more connected with others in the program, state, and industry. For example, a fellow spoke about the program’s role in benefitting people and communities. Fellow 20 stated, “one of the things I am interested in learning through the VALOR experience is how to better help people from all walks of life better understand

agricultural practices and to make better decisions and EDUCATED decisions for themselves.” This fellow intended to utilize their development through the program to build capacity for others. Another fellow took a similar stance, but focused more on the potential for capacity development within the agricultural industry.

With a mission to develop leaders who can effectively engage all segments of the Virginia agricultural community to create collaborative solutions and promote agriculture inside and outside of the industry, I’m thrilled that the program welcomes a diverse set of interests and leaders. (Fellow 19)

While fellows frequently blogged about these views on capacity building, others had a different view on interconnectedness. Some fellows spoke more about their own opportunities to increase their networks and others expressed an affiliation to the state and agriculture.

**Networking.** Many fellows voiced the importance of building networks both within and outside of the program, which resulted in the development of networking as a subtheme. Fellow 4 wrote, “One of the most valuable aspects of VALOR thus far has been access to individuals and organizations making things happen in the industry.” This fellow saw the value of building a network as a pathway to improve the industry. Another fellow spoke about previous networking opportunities that were beneficial to their development and attributed these previous experiences to their excitement to continue growing their network through the program.

I was fortunate again the past year to be accepted into VALOR – [cohort]. All I could think of upon receiving my acceptance is....what an opportunity to learn even more, build a bigger network and work even harder for my community. (Fellow 15)

Both fellows viewed networks as beneficial and shared sentiment about the value of the networking opportunities offered through the VALOR program.

**Affiliations.** Within this subtheme, fellows discussed interconnectedness as an affiliation to their state and/or the agricultural industry and an avenue for advocacy within the industry. For example, Fellow 16 saw the seminars as an opportunity to gain knowledge and experiences to benefit their community, state, and industry.

I need to look at each as an opportunity for learn and grow as an individual but just as importantly I need to look at each as an opportunity to play my part in building a stronger ag and forestry economy locally and statewide.

Another commented on the importance of understanding a growing and changing industry to be an effective advocate for their industry of affiliation. This fellow stated, “Times have changed, but I think learning how meat is processed is an important part of a holistic agriculture education and is vital to being an effective advocate for agriculture” (Fellow 25). Fellow 6 took a more political stance acting as an advocate for the agricultural industry, by expressing frustration in the current state of administration involved in policy change for environmental issues.

I do not begrudge a group[‘]s efforts to protect the environment or the life that inhabits it. I do not question the scientific rational[e] for policy change regarding the environment or the life that inhabits it. I was surprised by the stark difference in opinion between the people “on the ground” and the administration. I am frustrated by the over reliance of leadership that maintains organizational direction based solely on “them versus us” mentalities. I am concerned that as a country we have put ourselves into cliques wherein we allow ourselves to purposefully ignore the bigger picture, missing the forest for the trees. (Fellow 6)

This fellow vividly shared an affiliation with the agricultural industry and disdain for blame for environmental issues being attributed to the industry.

### Theme and Subtheme Connections to Program Outcomes

The research team compared the themes and subthemes, which emerged through this study, to program outcomes to explore connections between blog entry reflections and the intended program outcomes. The short-term, mid-term, and long-term outcomes associated with each theme and subtheme are displayed in Table 1.

Table 1  
*Program Outcome Connections to Themes*

	Short-term	Mid-term	Long-term
Expanded Thinking (Self-awareness & change)	<ul style="list-style-type: none"> <li>• Knowledge and understanding of industry</li> <li>• Better understanding of others and differing perspectives</li> <li>• Technology adoption and awareness</li> <li>• Self-awareness</li> </ul>	<ul style="list-style-type: none"> <li>• Information analysis and critical thinking</li> <li>• Understanding the role of the government in industry</li> </ul>	<ul style="list-style-type: none"> <li>• Credible advocates for the industry</li> <li>• Address industry challenges</li> <li>• Sustainability and viability of industry</li> </ul>
Competency Development	<ul style="list-style-type: none"> <li>• Enhanced communication skills</li> <li>• Conceptual understanding of leadership skills</li> </ul>	<ul style="list-style-type: none"> <li>• Develop dialogue skills to better understand and engage others</li> <li>• Applying leadership principles and skills</li> <li>• Leadership habits</li> </ul>	<ul style="list-style-type: none"> <li>• Self-efficacy and skill building</li> </ul>
Interconnectedness (Networking & Affiliation)	<ul style="list-style-type: none"> <li>• Engage diverse viewpoints</li> </ul>	<ul style="list-style-type: none"> <li>• Build relationships</li> </ul>	<ul style="list-style-type: none"> <li>• Strong, diverse network</li> <li>• Influencing policy</li> </ul>
Not Included	<ul style="list-style-type: none"> <li>• Listening skills</li> </ul>		<ul style="list-style-type: none"> <li>• Civic engagement</li> </ul>

*Note.* Outcomes were derived from Burbaugh et al. (2017) article and compared with themes. Two of the outcomes were not readily discussed within selected blog passages.

## Conclusions and Implications

Understanding leadership processes provides new opportunities to expand current knowledge regarding current theories and models (Dinh et al., 2014). This study examined VALOR fellows' blog entries for reflections on capacity building and competency development through experiences within the program. The researchers then connected the three emergent themes, expanded thinking, competency development, and interconnectedness, to intended program outcomes.

Burbaugh et al. (2017) identified the learning activities, which led to desired outcomes through a participatory pathway model approach. Within this study, it was not clear whether the program was the only contributing factor or only one of many contributing factors, which resulted in program outcomes. Because we are social beings and learning is a product of our environment, there is never a way to contribute an intervention as the sole reason behind an outcome. However, by examining products from reflective processes, connections can be attributed to learning, which aligned with outcomes, to specific experiences within the VALOR program.

From a transformative lens, adult learners must question their deep-rooted assumptions and beliefs to adopt a new paradigm and gain new knowledge (Sammut, 2014). This social learning process often encompasses a phase of disorientation, one of personal reflection, and an open engagement in discourse (Mezirow, 1997). Self-awareness arose as a subtheme within expanded thinking, which reflected exploration of a transformative learning process. For example, Fellow 2 explicitly discussed reexamining one's self in relation to experiences within the seminar. Fellow 32 reflected on realizing they did not know things they had previously believed they did. Within this passage, the fellow reminds us of the importance in being open-minded and seeking additional information to identify blind spots (Brookfield, 2016).

Although many fellows discussed transformative processes, others did not reflect upon their experiences, but rather utilized their blogs to detail the seminar. The researchers noted a trend in the blogs discussing the international seminar being predominately focused on specifics of the experience rather than reflections upon the experience. None of the blogs on the international experience within the sample provided any reflection upon the benefit of inclusion of an international experience or transfer of global perspectives. Increasing the focus on developing reflective processes and providing more instructions for blog entries are opportunities to improve the curriculum and enable fellows to receive greater gains from seminars.

Interconnectedness as a theme aligns with an individual's CoP. Networking opportunities and inclusion as a fellow within the program allows participants to build their CoP and form a fellows CoP. A previous study of an agricultural leadership program supported networking opportunities as an important part of the experience for participants (Kelsey & Wall, 2003). However, this study called for focus to shift to means for influencing and developing capacity within one's community (Kelsey & Wall, 2003). Recall, there is also a need to connect one's CoP to a complex social system of interrelated CoPs (Wenger, 2010). Within this study, researchers found implications of affiliation with and within a wider social system. Participants discussed their want and drive to impact their local communities and the agricultural industry.

Fellows also identified a need to be open to change and drive change. However, most blogs lacked application for the “how”. Fellows clearly expressed a desire to increase capacity within their local communities, the state, and agricultural industry, but few moved past awareness to express means for increasing social capital and impacting their communities as suggested as a need in previous studies (e.g. Horlings & Padt, 2013; Kelsey & Wall, 2003). Additionally, civic engagement was one of the two intended program outcomes, which did not align with an emergent theme. Practitioners should spend more time exploring the “how” with fellows to ensure knowledge transfer is occurring and external capacity is being built.

### **Recommendations**

This qualitative case-study evaluation provided insight in the leadership process and developmental outcomes of fellows within the VALOR program. The findings indicate several recommendations for program improvement and continued inquiry. In practice, fellows should be encouraged to engage in more reflective discussions with one another and provided more instructions and guidance for utilizing blogging as a reflective process. Guided questions for blogging, especially for the first few seminars, could bolster a more reflective blogging process. Additionally, fellows should be encouraged to take advantage of each other’s blogs as a CoP and to share their blogs and the blogs of other fellows with the wider agricultural community. Program personnel should consider opportunities to engage alumni of the program and strengthen opportunities for community development through a web-based platform (Yang, 2009).

Fellows should be provided with more opportunities to make meaningful connections with their current work, new-found knowledge, and experiences within the program to increase transferability. More engaged reflective processes will benefit these connections, but explicit discourse must occur (Mezirow, 1997). Fellows are completing the program with increased competencies and capacity to positively drive change within their own communities. Fellows need to explore different methods and avenues for application of tools learned within the VALOR program. Without a plan for application, fellows will not be as equipped or likely to partake in civic-minded projects and increase social capital. Program personnel should explore opportunities for reflection upon application to increase an understanding for transferability.

In summary, within leadership inquiry it is essential to explore processes and outcomes of the VALOR program. This program and similar programs are tasked with increasing the effectiveness of leaders equipped to address 21<sup>st</sup> challenges within the agricultural industry (Kaufman & Carter, 2005). To do so, it is essential to create robust evaluations, which provide sufficient insight to drive program support and implement improvements to the program (Lamm et al., 2016). By examining results of a reflective process, the researchers were able to explore how emergent themes within fellows’ blogs aligned with program outcomes.

## References

- Allen, S. J., & Hartman, N. S. (2008). Leadership development: An exploration of sources of learning. *SAM Advanced Management Journal*, 73(1), 10-19.
- Ary, D., Jacobs, L.C., & Sorensen, C.K. (2010). *Introduction to research education*. (8<sup>th</sup> ed.). Belmont, CA: Wadsworth.
- Avolio, B. J. (2007). Promoting more integrative strategies for leadership theory-building. *American Psychologist*, 62(1), 25-33. doi: 10.1037/0003-066X.62.1.25
- Bernard, H. R., Wutich, A., & Ryan, G. W. (2016). *Analyzing qualitative data: Systematic approaches*. Los Angeles, CA: SAGE publications.
- Black, A. M., & Earnest, G. W. (2009). Measuring the outcomes of leadership development programs. *Journal of Leadership & Organizational Studies*, 16(2), 184-196. doi:10.1177/1548051809339193
- Brescia, W. F., & Miller, M. T. (2006). What's it worth? The perceived benefits of instructional blogging. *Electronic Journal for the Integration of Technology in Education*, 5, 44-52.
- Brookfield, S. (2016). So what exactly is critical about critical reflection? In J. Fook, V. Collington, F. Ross, G. Ruch, & L. West (Eds.), *Researching critical reflection: Multidisciplinary approaches* (pp. 11-22). New York, NY: Routledge.
- Brungardt, C. (1997). The making of leaders: A review of the research in leadership development and education. *Journal of Leadership Studies*, 3(3), 81-95.
- Burbaugh, B., Seibel, M., & Archibald, T. (2017). Using a participatory approach to investigate a leadership program's theory of change. *Journal of Leadership Education*, 16(1), 192-204. doi:1012806/V16/I1/A3
- Chu, S. K., Chan, C. K., & Tiwari, A. F. (2012). Using blogs to support learning during internship. *Computers & Education*, 58(3), 989-1000.
- Corbin, J., & Strauss, A. (1990). Grounded theory research: Procedures, canons and evaluative criteria. *Zeitschrift für Soziologie*, 19(6), 418-427.
- Creswell, J. W. (2013). *Research design: Qualitative, quantitative, and mixed methods approach*. Los Angeles, CA: Sage Publications.
- Creswell, J. W., & Miller, D. L. (2000). Determining validity in qualitative inquiry. *Theory Into Practice*, 39(3), 124-130.
- Dennen, V. P. (2014). Becoming a blogger: Trajectories, norms, and activities in a community of practice. *Computers in Human Behavior*, 36, 350-358. doi:10.1016/j.chb.2014.03.028



- Densten, I. L., & Gray, J. H. (2001). Leadership development and reflection: what is the connection?. *International Journal of Educational Management*, 15(3), 119-124.
- Dinh, J. E., Lord, R. G., Gardner, W. L., Meuser, J. D., Liden, R. C., & Hu, J. (2014). Leadership theory and research in the new millennium: Current theoretical trends and changing perspectives. *The Leadership Quarterly*, 25(1), 36-62.
- Eckert, P. (2006). Communities of practice. *Encyclopedia of Language and Linguistics*, 2(2006), 683-685.
- Galloway, R. F. (1997). Community leadership programs: New implications for local leadership enhancement, economic development, and benefits for regional industries. *Economic Development Review*, 15(2), 6-9.
- Gardner, W. L., Lowe, K. B., Moss, T. W., Mahoney, K. T., & Cogliser, C. C. (2010). Scholarly leadership of the study of leadership: A review of The Leadership Quarterly's second decade, 2000–2009. *The Leadership Quarterly*, 21(6), 922-958.
- Hanks, S. K., Kaufman, E. K., Friedel, C. R., Clegorne, N. A., Seibel, M. M., Brunton, K. C., & Burbaugh, B. J. (2015). A Model of Leader Development Across the Life Span. Virginia Cooperative Extension, 104P, 1-7.
- Harvey, M., & Jenkins, D. M. (2014). Knowledge, praxis, and reflection: The three critical elements of effective leadership studies programs. *Journal of Leadership Studies*, 7(4), 76-85. doi: 10.1002/jls.21314
- Holmes, J., & Meyerhoff, M. (1999). The community of practice: Theories and methodologies in language and gender research. *Language in Society*, 28(2), 173-183.
- Horlings, I., & Padt, F. (2013). Leadership for sustainable regional development in rural areas: Bridging personal and institutional aspects. *Sustainable Development*, 21(6), 413-424. doi: 10.1002/sd.526
- KARL. (2017). *IAPAL directory*. Retrieved from <http://karlprogram.com/resources/iapal-directory/>
- Kaufman, E. K., & Carter, H. S. (2005). Agricultural leadership development: From networking to application. *Journal of Leadership Education*, 4(2), 66-75.
- Kaufman, E. K., Rateau, R. J., Carter, H. S., & Strickland, L. (2012). What's context got to do with it? An exploration of leadership development programs for the agricultural community. *Journal of Leadership Education*, 11(1), 121-139.

- Kelsey, K. D., & Wall, L. J. (2003). Do agricultural leadership programs produce community leaders? A case study of the impact of an agricultural leadership program on participants' community involvement. *Journal of Agricultural Education, 44*(4), 35-46.
- Lamm, K. W., Carter, H. S., & Lamm, A. J. (2016). Evaluating extension based leadership development programs in the southern United States. *Journal of Agricultural Education, 57*(1), 121-136. doi:10.5032/jae.2016.01121
- McClure, M. M., Fuhrman, N. E., & Morgan, A. C. (2012). Program evaluation competencies of extension professionals: Implications for continuing professional development. *Journal of Agricultural Education, 53*(4), 85-97. doi:10.5032/jae.2012.04085
- Mezirow, J. (1997). Transformative learning: Theory to practice. *New Directions for Adult and Continuing Education, 1997*(74), 5-12.
- Northouse, P. G. (2013). *Leadership theory and practice* (6th ed.). Thousand Oaks, CA: Sage.
- Sammut, K. (2014). Transformative learning theory and coaching: Application in practice. *International Journal of Evidence Based Coaching & Mentoring, 8*(8), 39-53.
- Thoron, A. C., Myers, B. E., & Barrick, R. K. (2016). Research priority 5: Efficient and effective agricultural education programs. In T. G. Roberts, A. Harder, & M. T. Brashears (Eds.), *American Association for Agricultural Education national research agenda: 2016-2020* (pp. 41-48). Gainesville, FL: Department of Agricultural Education and Communication.
- Wenger, E. (2010). Communities of practice and social learning systems: the career of a concept. *Social Learning Systems and Communities of Practice, 3*, 179-198.
- Wenger, E. (2011). *Communities of practice: A brief introduction*. Retrieved from <https://scholarsbank.uoregon.edu/xmlui/bitstream/handle/1794/11736/A%20brief%20introduction%20to%20CoP.pdf?sequence=E2%80%B0=%E2%80%B1>
- Wenger, E., McDermott, R., & Snyder, W. M. (2002). *Cultivating communities of practice*. Boston, MA: Harvard Business School Press.
- Wenger, E. C., & Snyder, W. M. (2000). Communities of practice: The organizational frontier. *Harvard Business Review, 78*(1), 139-146.
- Williams, P. 2002. *The Paradox of Power: A Transforming View of Leadership*. New York, NY: Warner Books.
- Yang, S. H. (2009). Using blogs to enhance critical reflection and community of practice. *Journal of Educational Technology & Society, 12*(2), 11-21.

## **Student Perspective of the Desired Roles Educators Play – A Q Methodology Study**

Carley Snider, Oklahoma State University  
Joenelle Futrell, Oklahoma State University  
Marshall A. Baker, Oklahoma State University

### **Abstract**

The purpose of this Q-methodology study was to understand the perceptions of rural first-year undergraduate students regarding characteristics of great educators. Forty-five participants sorted 36 cards based on two conditions of instruction. Three perspectives arose following a principal components analysis and VARIMAX rotation. First, students perceived that their greatest educator valued them as an individual and sought to build a personal relationship with them. The second perspective indicated that students believed their greatest educator was rigorous and structured in the classroom. The third perspective was holistic in nature, balancing multiple educator characteristics. The researchers recommend that educators work to further engage learners in the process of learning.

### **Introduction/Need for Research**

Students need the support of educators, so they are prepared to rise to meet the expectations of schools and society. Educators provide social and academic structure, care for students and their futures, and set standards within the school system (Klem & Connell, 2004). Though students may evaluate the quality of their educators based on varying factors (Costin, Greenough, & Menges, 1971; Watchel, 1998), there are well-studied characteristics of the effective educator at both the secondary and post-secondary level. Rosenshine and Furst (1971) determined eleven teacher behaviors that lead to higher learner achievement with five primary behaviors identified as teacher clarity, variability within and between lessons, teacher enthusiasm, task-oriented teachers, and teachers who create opportunities for students to learn criterion material (Rosenshine & Furst, 1971). Effective post-secondary teachers have been described as someone who stimulates interest and is understandable (Feldman, 1976), is knowledgeable (Latif & Miles, 2013), facilitates quality student-faculty contact (Wilson, 2004), and makes learning enjoyable and is invested in lifelong learning (Farmer & Frenn, 2009).

As effective teachers display a variety of these characteristics in their pedagogy, Kolb and Kolb (2017) promote that a successful and experienced teacher will blend the four educator roles of facilitator, subject-expert, standard-setter/evaluator, and coach into their practice. These roles, grounded in the experiential learning theory concepts of the learning cycle, allow us to identify the roles educators adopt with learners (Kolb, 2015). Kolb et al. (2014) shared that educators would ideally be balanced in all four educator roles in order to best catalyze the learning process. Baker and Twenter (2016), however, found that educators in Oklahoma were not balanced and strongly preferred the coaching role. Though research has described educators' perceptions through the use of the Kolb Educator Role Profile (ERP) instrument, there is no such measure to identify learners' preferences for each of the roles. As such, there is no research exploring the learners' perspectives and preferences for teaching behaviors related to the four educator roles outlined by Kolb et al. (2014). What do learners prefer in an exemplary educator? Do they prefer the balance described as superior by Kolb et al. (2014)? Research Priority Four of the

National Research Agenda: American Association for Agricultural Education 2016-2020 (Roberts, Harder, & Brashears, 2016) calls for meaningful, engaged learning in every environment. As such, a study focused on student perspectives of the characteristics of educators who have been deemed as “great” by the student, would be beneficial in further understanding the role of the educator in student engagement.

### **Theoretical/Conceptual Framework**

In order to view the process of learning and education holistically, Kolb’s experiential learning theory was used as a theoretical framework. This theory views learning as a process where learners experience four modes of learning: concrete experience, reflective observation, abstract conceptualization, and active experimentation (Kolb, 2015, p. 42). Concrete experience is the open and unbiased engagement of a learner within an experience (Kolb, 2015, p. 42). Reflective observation is defined as the ability to reflect on the experience from a variety of lenses (Kolb, 2015, p. 42). Abstract conceptualization is the mode of creating ideas to integrate the reflections into sound theories (Kolb, 2015, p. 42). Active experimentation is the utilization of these formed theories to make choices and further develop knowledge in the future (Kolb, 2015, p. 42). Kolb (2015, p. 42) stresses the importance of a learner enduring all four modes of learning in order to maximize a learning experience. Kolb (2015, p. 302) emphasizes the need for educators to adapt their teaching styles to meet the various needs of learners within the learning cycle. Kolb (2015, p. 303) defines an educator role as “a patterned set of behaviors that emerge in response to the learning environment, including students and the learning task demands.” Kolb (2015, p. 303) explores the various roles the educator can take with learners through the Educator Role Profile (ERP) preferred educator positions: facilitator, expert, evaluator, and coach as shown in Figure 1.

The facilitator role is conveyed by educators whom adopt a personable demeanor to help learners engage in experiences through a reflective state (Kolb, 2015, p. 304). The expert educator role is seen through the content expertise of the educator expressed in an analytical and reflective style (Kolb, 2015, p. 304). The evaluator role is emphasized by educators who accentuate the need for learners to master a subject and have the ability to easily apply the knowledge and/or skill to meet a standard of performance (Kolb, 2015, p. 304). The coaching role is expressed in educators who place importance on helping learners to obtain and apply knowledge in the realm of achieving goals (Kolb, 2015, p. 304).

“Experiential learning theory suggests that education is not something one does *to* students through implementation of a set of techniques. Rather, it is something educators do *with* learners in the context of meaningful relationships and shared experiences” (Kolb, 2015, p. 300) Kolb’s ERP emphasizes different qualities and actions for the educator to possess when undergoing the experiential learning theory’s learning process *with* learners (2015, p. 303) as outlined in figure 1. The ERP was designed by Kolb to allow educators to find the environments, content, and techniques where their preferred teaching styles excel most and how they can adapt those preferences to educate around the learning cycle model (Kolb, 2015, p. 302).

## Educator Roles and the Learning Cycle

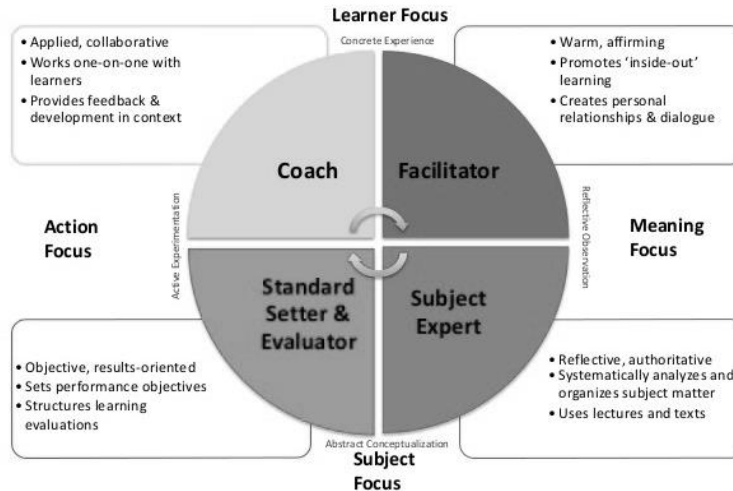

Figure 1. Kolb's educator roles and the learning cycle model (Kolb, 2015, p. 303)

### Purpose of the Study

The purpose of this study was to further understand the student perceptions of the role of the educator in both the secondary and post-secondary realm. The research question guiding this study is: *What perceptions do rural first-year undergraduate students have regarding characteristics of great educators?*

### Methods and Procedures

The 45 sorters in this study were first-year students at Oklahoma State University enrolled in the McKnight Scholar Leadership Program. The purpose of this program is to equip young leaders who excel in scholarship and service. Therefore, these students have successfully engaged with their high school teachers and college professors. We have agreed that the Q-sort methodological approach would be effective in this study because this approach understands the subjectivity of human perception and is used to detect participants' perceptions of the world around them (McKeown & Thomas, 2013, p. 1). Q methodology, designed by William Stephenson, is a research technique that utilizes the Q-sort to collect data that represents the participants' subjective perception (Watts & Stenner, 2013, p. 4). Through this method, representative statements are selected based off a condition and participants arrange their views of these items using a forced distribution (McKeown & Thomas, 2013, p. 3) as shown in figure 3.

To begin this study, participants were given a set of 36 randomized statements. Each participant was asked to sort the statements based off of two separate conditions of instruction. The first condition of instruction was sorting based on the statement "My best high school teacher..." Participants were asked to initially sort the statements into three distinct categories: (a) definitely agree, (b) unsure/indifferent, (c) definitely disagree. Next, participants placed the statements on the provided Q-sort board with a forced distribution ranging from -4 (most disagree) to +4 (most agree). After completing this task, students were instructed to clear their boards. Each participant

was then asked to sort the statements based off the second condition of instruction. The second condition was sorting based on the statement “My greatest college professor...” Students again sorted the 36 randomized statements into three distinct categories: (a) definitely agree, (b) unsure/indifferent, (c) definitely disagree, and then placed the statements onto the Q-sort board.

Utilizing PQMethod, Centroid Factor Analysis (CFA) was used followed by a VARIMAX rotation to optimize factor development. Interpretation was based on factor arrays since factors in Q-methodology cannot be determined solely on statistical measures (Brown, 1980). Each factor array includes the replacement of statements on a sorting board and peer debriefing to identify and name each factor array.

### **Instrument Development**

Using the conceptual framework of Kolb’s ERP, (2015, p. 303) a Q set of 36 statements for participants to sort through were created. Nine representative statements were developed for each of the four educator roles as shown in Table 1.

Table 1.

*Categories of the Q-set*

<b>Educator Role</b>	<b>Description of Educator Role Concept</b>	<b># of Statements</b>
Facilitator	Statements that emphasized the educator’s affirming teaching style and the creation of a strong student-teacher relationship.	9
Expert	Statements that emphasized the educator’s strong content expertise and their analytical approach to teaching.	9
Evaluator	Statements that emphasized the educator’s focus on meeting performance requirements and providing clear classroom expectations and standards.	9
Coach	Statements that emphasized the educator’s focus on encouragement and goal development with students.	9

The 36 statements were developed to relate to Kolb’s four educator role profiles: facilitator, expert, evaluator, and coach (2015, p. 303). The provided Q-sort board, as shown in figure 3, required participants to utilize a forced distribution of the statements in relation of the condition of instruction. Participants were forced to identify the statements of which they most agreed and the statements of which the most disagreed.

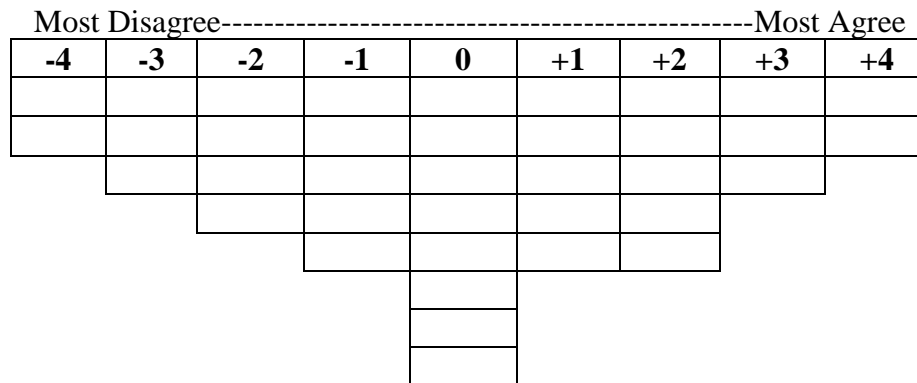

Figure 3. Q-sort board structure utilized for this study

### Results

The solution found utilized a three-factor centroid factor analysis which was followed by a VARIMAX rotation. Study of the factor matrix (see Table 2) was conducted to discover the sorts that most define the final factor array by selecting sorts that were statistically-significant for a single factor. A sort was measured as defining a factor if the correlation of the sort to the factor was measured as statistically significant by the formula:  $(1/\sqrt{\text{number of statements}}) * 2.58$  (Watts & Stenner, 2012). Per the use of this equation, statistical significance was determined to be standardized at 0.43 for this study. Distributions of the sorts across the three factors are displayed in Table 2.

Table 2.

#### *Factor Matrix with Bold Marking Defining Sorts*

Sort # / Condition	Gender	High School Graduating Class Size	Factor Loadings		
			1	2	3
03-Teacher	Female	115	<b>0.5770</b>	-0.2856	-0.0886
05-Teacher	Female	13	<b>0.5813</b>	0.3004	0.0978
07-Teacher	Female	275	<b>0.6213</b>	0.1217	0.2103
08-Teacher	Female	87	<b>0.6784</b>	-0.1803	0.2091
10-Professor	Female	350	<b>0.5993</b>	0.2823	-0.1193
11-Teacher	Female	365	<b>0.6492</b>	0.2710	-0.1279
12-Teacher	Male	56	<b>0.6564</b>	0.1020	0.1514
15-Teacher	Female	800	<b>0.7204</b>	-0.2322	0.1769
16-Teacher	Female	108	<b>0.5565</b>	0.0771	0.3647
17-Teacher	Female	480	<b>0.4752</b>	-0.2458	0.4048
18-Teacher	Male	56	<b>0.6099</b>	-0.1430	-0.0904
21-Teacher	Female	56	<b>0.5977</b>	-0.0124	0.1588
22-Teacher	Female	273	<b>0.6631</b>	-0.0560	0.0983
25-Teacher	Male	228	<b>0.4714</b>	0.1275	0.4380
28-Teacher	Male	92	<b>0.6321</b>	-0.2628	0.0633
32-Professor	Male	564	<b>0.4555</b>	0.2295	-0.0217

34-Teacher	Female	667	<b>0.5144</b>	0.1251	-0.1877
35-Professor	Female	93	<b>0.6513</b>	0.2180	0.0222
35-Teacher	Female	93	<b>0.6251</b>	-0.1786	0.3634
36-Teacher	Female	370	<b>0.4938</b>	0.0181	-0.0530
37-Professor	Female	268	<b>0.4479</b>	-0.0399	-0.0153
39-Teacher	Female	369	<b>0.4878</b>	0.2608	0.2031
43-Teacher	Female	350	<b>0.4563</b>	-0.2698	-0.0585
01-Teacher	Male	58	-0.0006	<b>0.5121</b>	0.0030
02-Professor	Female	306	-0.1993	<b>0.6326</b>	0.2476
04-Teacher	Female	565	-0.0308	<b>0.5088</b>	0.1053
05-Professor	Female	13	0.0004	<b>0.7219</b>	-0.0922
07-Professor	Female	275	0.0241	<b>0.6654</b>	0.0095
08-Professor	Female	87	0.2320	<b>0.6183</b>	0.4246
15-Professor	Female	800	0.1819	<b>0.5607</b>	0.0799
16-Professor	Female	108	0.01310	<b>0.6109</b>	-0.2926
17-Professor	Female	480	0.3505	<b>0.5121</b>	0.0347
19-Professor	Male	450	0.4413	<b>0.4604</b>	0.1477
20-Professor	Female	220	-0.1566	<b>0.5345</b>	0.0125
20-Teacher	Female	220	0.3195	<b>0.6516</b>	-0.2972
21-Professor	Female	56	0.1825	<b>0.7481</b>	-0.1712
22-Professor	Female	273	-0.1104	<b>0.7509</b>	-0.2546
24-Professor	Female	316	-0.0904	<b>0.6715</b>	0.1121
27-Professor	Female	721	0.1240	<b>0.7609</b>	0.2430
30-Professor	Male	118	0.2008	<b>0.5935</b>	0.2128
31-Professor	Male	24	0.0943	<b>0.4996</b>	-0.0135
34-Professor	Female	667	-0.1793	<b>0.6372</b>	-0.2429
36-Professor	Female	370	-0.2819	<b>0.6858</b>	-0.0946
38-Professor	Female	606	-0.0561	<b>0.6134</b>	-0.0574
38-Teacher	Female	606	-0.2930	<b>0.7281</b>	-0.3087
40-Professor	Female	230	-0.2561	<b>0.7779</b>	0.1491
40-Teacher	Female	230	0.1155	<b>0.4699</b>	0.2610
43-Professor	Female	150	0.0353	<b>0.7386</b>	-0.3811
45-Professor	Male	49	0.2910	<b>0.5956</b>	-0.1817
01-Professor	Male	58	0.1709	0.1532	<b>0.6111</b>
06-Professor	Female	28	-0.1109	0.3549	<b>0.5725</b>
06-Teacher	Female	28	0.0008	0.0824	<b>0.7087</b>
11-Professor	Female	365	0.0903	0.0358	<b>0.7972</b>
13-Teacher	Male	26	0.1303	-0.3553	<b>0.4465</b>
18-Professor	Male	56	0.2224	0.1813	<b>-0.4589</b>
24-Teacher	Female	316	0.2017	0.0853	<b>0.5161</b>
25-Professor	Male	228	0.0634	0.1131	<b>0.6504</b>
26-Professor	Male	136	0.0846	0.2907	<b>0.4131</b>
29-Teacher	Female	383	0.4075	-0.2739	<b>0.5164</b>
30-Teacher	Male	118	-0.0356	-0.3345	<b>0.4582</b>
32-Teacher	Male	564	0.2934	-0.0503	<b>0.4455</b>
41-Professor	Female	430	0.3036	-0.3326	<b>0.7495</b>



43-Teacher	Female	150	-0.0505	-0.2791	<b>0.5104</b>
02-Teacher	Female	306	0.5953	-0.0715	0.6323
03-Professor	Female	115	0.3769	0.2097	-0.3531
04-Professor	Female	565	-0.0117	0.1464	0.3472
09-Professor	Male	700	-0.0928	0.2572	0.3127
09-Teacher	Male	700	0.0122	0.0273	0.4354
10-Teacher	Female	350	0.4699	-0.4392	0.5944
12-Professor	Male	56	0.7777	0.2609	0.0173
13-Professor	Male	26	0.0263	0.4080	0.3841
14-Professor	Male	26	0.3296	-0.1302	0.2535
14-Teacher	Male	26	0.4976	0.4685	0.0679
19-Teacher	Male	450	0.3945	0.2034	0.3911
23-Professor	Male	76	-0.2372	0.3771	0.4216
23-Teacher	Male	76	0.3516	-0.3485	0.4037
26-Teacher	Male	136	0.4711	-0.3919	0.4706
27-Teacher	Female	721	0.5867	0.5433	-0.1141
28-Professor	Male	92	-0.0151	-0.0174	-0.3108
29-Professor	Female	383	-0.0795	0.6328	-0.4620
31-Teacher	Male	24	0.3839	0.3246	0.1871
33-Professor	Female	82	-0.4911	0.4888	0.1627
33-Teacher	Female	82	0.2315	0.4429	-0.4395
37-Teacher	Female	268	0.5572	-0.5222	0.2036
39-Professor	Female	369	-0.3132	0.3452	0.1048
42-Professor	Female	43	0.4020	0.3876	-0.1589
42-Teacher	Female	43	0.0578	0.2290	0.1856
43-Professor	Female	350	0.4284	0.2117	0.1298
45-Teacher	Male	49	0.3528	0.2973	0.2177
# of Defining Sorts			24	26	14
% Explained Variance			14	17	11

Note: Factor loadings in boldface indicate a defining sort.

Factor scores in boldface indicate they have met the standard criteria of 0.43 for this study and are utilized when defining the factor and its interpretive meaning. The factor score displays the level of similarity present in that factor array. An example is sorter number twenty-seven-professor which would be considered a high and pure loader as she loaded low on the first and third factors, yet very high with a 0.76 on the second factor. High and pure loaders are used to most clearly express the nature of the sort. If an individual was found to be similarly scored to multiple views, the sort was determined to be confounding and was not used to describe the array. An example is sorter number thirty-seven-teacher, which showed similar loads for factors one and two at 0.55 and -0.52 respectively. If a sort was not determined to be statistically significant on any factor, it was not considered in the definition of the array as it was non-significant. In this analysis, twenty-four sorts defined the first factor, twenty-six sorts defined the second factor, and fourteen sorts defined the third factor. Nine sorts were considered as confounding and seventeen sorts were found to be non-significant. The correlation of the three identified factors to one another is important to note. Correlations were an indication of how similar or different the factors were to one another. In this study the correlations were  $r =$

0.0028<sub>(1-2)</sub>; 0.3377<sub>(1-3)</sub>; and -0.1079<sub>(2-3)</sub>. This indicates that though there is a low positive correlation between factors one and three, the factor is still uniquely defined (Watts & Stenner, 2012).

Three factors emerged from the analysis. Each factor represents an individual perspective a college freshman may have of their “greatest” educator, whether it be a high school teacher or a university professor. Each perspective will be described narratively to explain the perspective of the individuals who defined that perceptive factor. Exact statements from the sort will be provided to support the narrative of the perception describing each factor array (noted in parentheses by statement number, *z-score*, and array position, respectively).

### **Perspective A: My Greatest Educator Knew Me as a Person.**

Twenty-four students had the view that their greatest educator valued them as individuals (23, +4, 1.49) and believed that their greatest educator was someone who clearly knew them, including their values and background (26, +3, 0.95). However, these students did not believe that they were regularly made to reflect on what they had learned from their greatest educator in a structured way (34, -4, -1.73). The “my greatest educator knew me as a person” perspective was not particularly diverse, as it was comprised of 18 female sorters and six male sorters. Additionally, the condition for which this factor was sorted for was primarily condition one, teacher, as 20 participants sorted their response for teacher in this perspective and four participants sorted their response for condition two, professor, in this perspective.

For those who aligned with this perspective, the belief that their greatest educator was someone they worked hard not to disappoint because the personal investment the educator had in the student (25, +4, 2.09) was indicative. However, those holding this perspective did not believe that their greatest educator demanded students to master the course content taught to complete accuracy (4, -3, -1.52), designed lessons around what the student was interested in learning (16, -3, -1.68), or required them to read about the content in a rigorous manner (32, -3, -1.55). It was clear that these respondents believed their greatest educators filled a parental role (21, +3, 1.30) and was passionate about the subject taught, even outside of the classroom (29, +3, 1.20). Together, this love for the student and desire to understand and value the student as more than a line in a gradebook developed the emotion-filled perspective of the student that great educators know students as people.

Table 3.

*“My Greatest Educator Knew Me as a Person” Array Statements*

No.	Statement	Holistic Category	Z-Scores	Array Pos.
<b><u>Five highest ranked “Most Agree” statements</u></b>				
25	...was someone that I worked hard not to disappoint because I knew he or she was personally invested in me.	Facilitator	2.09	+4
23	..valued me as an individual including the prior knowledge I already have.	Facilitator	1.49	+4
26	...someone who clearly knew my values, background, and upbringing.	Facilitator	0.95	+3
29	...was obviously passionate about the subject they taught even outside of the classroom.	Expert	1.20	+3
21	...was almost like a parent rather than a teacher.	Facilitator	1.30	+3
<b><u>Five highest ranked “Most Disagree” statements</u></b>				
34	...regularly made me reflect on what we had learned through structured writing responses or group discussions.	Expert	-1.173	-4
6	...was more interested in the results I produced than the process of creating them.	Evaluator	-1.85	-4
4	...demanded that I master the content taught with 100% accuracy.	Evaluator	-1.152	-3
16	...designed lessons around what I was interested in learning about.	Coach	-1.68	-3
32	...required me to read about the content area regularly, intensely, and purposefully.	Expert	-1.55	-3
<b><u>“Most Agree” and “Most Disagree” highest ranked distinguishing statements</u></b>				
<i>Most Like</i>				
25	...was someone that I worked hard not to disappoint because I knew he or she was personally invested in me.	Facilitator	2.09	+4
21	...was almost like a parent rather than a teacher.	Facilitator	1.30	+3
26	...someone who clearly knew my values, background, and upbringing.	Facilitator	0.95	+3
<i>Most Disagree</i>				
34	...regularly made me reflect on what we had learned through structured writing responses or group discussions.	Expert	-1.173	-4
16	...designed lessons around what I was interested in learning about.	Coach	-1.68	-3
32	...required me to read about the content area regularly, intensely, and purposefully.	Expert	-1.55	-3

**Perspective B: My Greatest Educator was Rigorous.**

Twenty-six students held the perspective that their greatest educator was structured and set clear procedures (7, +3, 1.04) while showcasing evident passion about the subject matter they taught, even outside of the classroom (29, +4, 2.15). However, these students also perceived their greatest educator to not be someone who knew their values and backgrounds (26, -4, -1.95) and rather someone who challenged them to think critically and innovatively (33, +2, 0.78). They perceived their greatest educator to require them to meet their standards (8, +2, 0.80) while not being adamant that the student loved learning (17, -2, -0.78). The “my greatest educator was rigorous” perspective showed emphasis towards sorting for condition two, the professor, as 21 sorters sorted for this factor on that condition while five sorters sorted for factor two on condition one, the teacher. Additionally, there were a higher number of female sorters than male sorters to sort for this factor with 21 and five respectively showing significant sorts.

Sorters aligned to factor two sorted to say their greatest educator was authoritative and in command of the classroom at all times (30, +3, 0.89) while also not being someone who was parental (21, -4, -2.36) but purely served in their role as an educator while showing little concern for how the students developed as a person (11, -3, -1.14). Combined, the educator expertise and structured classroom proceedings developed the student perspective that great educators are rigorous.

Table 4.

*“My Greatest Educator was Rigorous.” Array Statements*

No.	Statement	Holistic Category	Z-Scores	Array Pos.
<b><u>Five highest ranked “Most Agree” statements</u></b>				
29	...was obviously passionate about the subject they taught even outside of the classroom.	Expert	2.15	+4
28	...was such an expert in his or her subject they could always answer my questions without looking anything up.	Expert	1.92	+4
30	...was very authoritative and in command of the classroom at all times.	Expert	0.89	+3
31	...lectured often and his or her lectures were always interesting and informative.	Expert	1.45	+3
7	...had a very structured classroom with clear procedures.	Evaluator	1.04	+3
<b><u>Five highest ranked “most disagree” statements</u></b>				
26	...was someone who clearly knew my values, background, and upbringing.	Facilitator	-1.95	-4
21	...was almost like a parent rather than a teacher.	Facilitator	-2.36	-4
11	...was primarily concerned with how I grew and developed as a person.	Coach	-1.14	-3
12	...definitely knew my career and personal goals.	Coach	-1.60	-3
22	...is someone I know that I could trust with anything.	Facilitator	-1.40	-3

**“Most agree” and “Most Disagree” Highest Ranked distinguishing statements**

<i>Most Agree</i>				
29	...was obviously passionate about the subject they taught even outside of the classroom.	Expert	2.15	+4
28	...was such an expert in his or her subject they could always answer my questions without looking anything up.	Expert	1.92	+4
31	...lectured often and his or her lectures were always interesting and informative.	Expert	1.45	+3
<i>Most Disagree</i>				
21	...was almost like a parent rather than a teacher.	Facilitator	-2.36	-4
26	...was someone who clearly knew my values, background, and upbringing.	Facilitator	-1.95	-4
12	...definitely knew my career and personal goals.	Coach	-1.60	-3

**Perspective C: My Greatest Educator Cared but Focused on Content.**

Fourteen students held the perspective that their greatest educator was concerned about how they developed as a person (11, +4, 1.18) while showing evident passion about the subject they taught, even outside of the classroom (29, +3, 1.39). However, these students also held the belief that their greatest educator did not push them to be organized (35, -2, -0.76) or demand they mastered the content taught with complete accuracy (4, -4, -1.93). These students sorted to say their greatest educator challenged them to think critically and innovatively about difficult concepts (33, +4, 1.66) but did not have a structured classroom with clear procedures (7, -3, -1.60). The “my greatest educator cared but focused on content” perspective showed no diversity with seven females and seven males sorting for this opinion. Additionally, seven sorters held this perspective for condition one, teacher, and seven sorters held this perspective for condition two, professor.

Students aligned to this perspective viewed their greatest educators as people who valued them as individuals (23, +3, 1.56) and whom they worked hard not to disappoint because of the educator’s vested interest in them as a student (25, +3, 1.07). However, these educators also did not create opportunities for practice before exams and projects (5, -3, -1.39). Together, these opinions showed students viewed their greatest educator as showcasing a love of learning and subject matter while having a classroom void of assessment to develop the student perspective that great educators care but focus on content.

Table 5.

*“My Greatest Educator Cared but Focused on Content.” Array Statements*

No.	Statement	Holistic Category	Z-Scores	Array Pos.
<b><u>Five highest ranked “most agree” statements</u></b>				
11	...was primarily concerned with how I grew and developed as a person.	Coach	1.18	+4
33	...challenged me to think critically and innovatively about difficult concepts and solving tough problems.	Expert	1.66	+4
23	...valued me as an individual, including the prior knowledge I already have.	Facilitator	1.56	+3
29	...was obviously passionate about the subject they taught, even outside the classroom.	Expert	1.39	+3
25	...was someone that I worked hard not to disappoint because I knew he or she was personally invested in me.	Facilitator	1.07	+3
<b><u>Five highest ranked “Most Disagree” statements</u></b>				
4	...demanded that I master the content taught with 100% accuracy.	Evaluator	-1.93	-4
6	...was more interested in the results I produced than the process of creating them.	Evaluator	-2.03	-4
5	...always created opportunities for practice before any large exams or projects were due.	Evaluator	-1.39	-3
1	...used structured rubrics to make sure I always knew how I would be evaluated on an assignment.	Evaluator	-1.72	-3
7	...had a very structured classroom with clear procedures.	Evaluator	-1.60	-3
<b><u>“Most Agree” and “Most Disagree” highest ranked distinguishing statements</u></b>				
<i>Most Agree</i>				
11	...was primarily concerned with how I grew and developed as a person.	Coach	1.18	+4
33	...challenged me to think critically and innovatively about difficult concepts and solving tough problems.	Expert	1.66	+4
25	...was someone that I worked hard not to disappoint because I knew he or she was personally invested in me.	Facilitator	1.07	+3
<i>Most Disagree</i>				
4	...demanded that I master the content taught with 100% accuracy.	Evaluator	-1.93	-4
1	...used structured rubrics to make sure I always knew how I would be evaluated on an assignment.	Evaluator	-1.72	-3
7	...had a very structured classroom with clear procedures.	Evaluator	-1.60	-3

## Conclusions, Discussion, and Recommendations

Three dominant positions exist within the students examined in this study. First, students find their greatest educator, most often a secondary school teacher, to be a person that knows them, cares about them, and values the student as a person. However, those holding that perspective did not highly value evaluation or expertise in the subject being taught. The second position, held most by those describing their professors, finds value in the rigor, structure, and attention to critical feedback. The third perspective, desires that all four roles as described by Kolb and Kolb (2017) be fulfilled – a more holistic approach that is described in theory as optimal.

Similar to the imbalance in educator role preferences of teachers identified by Baker and Twenter (2016), rural freshman college students in Oklahoma also held imbalanced preferences for certain roles. Specifically, one perspective wanted to be known and valued, but had very little appreciation or value placed on evaluative feedback or the authoritative expert roles. The second perspective valued educators that knew their content well and set high standards, but didn't find a great deal of value in the personal relationships or investment. The final perspective, appreciated a balanced educational approach most closely aligned with the ideal described by Kolb et al. (2014). Why is it that the first two perspectives did not find value in each of the educator roles? Do students identifying with the first perspective not understand the value of evaluative feedback in their own growth and development? Perhaps a career of educational assessment has perpetuated this apprehension for assessment. It is also interesting to examine the sorts by the two conditions of instruction. The first perspective, focusing on relationships, was dominated by sorters focusing on high school teachers. The second perspective, focusing on rigor, was dominated by those considering their best professor. What are the educational products of these two imbalanced approaches that seem to dominate secondary and post-secondary instruction? Does the additional effort to develop balance in educator roles lead to increased educational effectiveness as posited by Kolb et al. (2014)?

Learning style preferences would be informative in understanding the varied perspectives. Do the two perspectives representing strong polar preferences align with students learning preferences? If not, is a student's perspective of great teaching built upon their history and models of education? Adding the learning style preferences would clarify how students came to these subjective opinions.

## References

- Baker, M. A., & Twenter, J. (2016). An exploratory examination of the Kolb Experiential Educator Role Profile. *Proceedings of the 2016 National AAAE Research Conference, Kansas City, MO.*
- Brown, S. R. (1980). *Political subjectivity: Applications of Q methodology in political science.* New Haven: Yale University Press.
- Costin, F., Greenugh, W. T., & Menges, R. J. (1973). Student rating of college teaching: reliability, validity, and usefulness. *The Journal of Economic Education, 5*(1), 511-535. doi:10.2307/1182836

- Feldman, K. A. (1976). The superior college teacher from the students' view. *Research in Higher Education*, 5, 243-288. doi:10.1007/BF00991967
- Klem, A. M., & Connell, J. P. (2004). Relationships matter: linking teacher support to student engagement and achievement. *Journal of School Health*, 74(7), 264-273. doi:10.1111/j.1746-1561.2004.tb08283.x
- Kolb, A. Y., Kolb, D. A., Passarelli, A., Sharma, G. (2014). On becoming an experiential educator: The educator role profile. *Simulation & Gaming*, 45(2), 204-234. doi: 10.1177/1046878114534383
- Kolb, A. Y., & Kolb, D. A. (2017). *The experiential educator: principles and practices of experiential learning*. Kaunakakai, HI: EBL Press.
- Kolb, D. A. (2015). *Experiential learning: experience as the source of learning and development*. Upper Saddle River, NJ: Pearson Education, Inc.
- Latif, E., & Miles, S. (2013). Students' perception of effective teaching. *Journal of Economics and Economic Education Research*, 14(1), 121-129. Retrieved from <http://argo.library.okstate.edu/login?url=https://search.proquest.com/docview/1370192183?accountid=4117>
- McKeown, B., & Thomas, D. B., (2013). *Q methodology: series: quantitative applications in the social sciences*. (2<sup>nd</sup> ed.). Newbury Park, CA: Sage. doi:10.4135/9781483384412
- Roberts, T. G., Harder, A., & Brashears, M. T. (Eds.). (2016). *American Association for Agricultural Education national research agenda: 2016-2020*. Gainesville, FL: Department of Agricultural Education and Communication.
- Rosenshine, B., & Furst, N., (1971). Research on teacher performance criteria. In B. O. Smith (Ed.), *Research in Teacher Education* (pp. 37-72). Upper Saddle River, NJ: Prentice-Hall.
- Wachtel, H. K. (1998). Student evaluation of college teaching effectiveness: a brief review. *Assessment & Evaluation in Higher Education*, 23(2), 191-207. doi:10.1080/0260293980230207
- Watts, S., & Stenner, P. (2013). *Doing q methodological research theory, method and interpretation*. Los Angeles, CA: Sage.



## Faculty Motivations for Leading Short-Term Study Abroad Courses

Brandon Raczkoski, Oklahoma State University

J. Shane Robinson, Oklahoma State University

### Abstract

This case study explored the motivations faculty in the College of Agricultural Sciences and Natural Resources at Oklahoma State University have for developing and leading short-term study abroad courses or experiences. Four faculty members were included in this case study. Data were collected through semi-structured interviews and document review. Individual interviews were conducted after faculty had led a study abroad trip. The interviews explored faculty reflections on the outcomes of the experience. The documents reviewed included course syllabi, curriculum vitae, and the university international strategic plan. *Confidence building*, *student inspirations*, and *pre-existing structures* were the three themes that emerged regarding faculty's motivation for developing study abroad courses. As for leading a study abroad course, faculty were motivated by the opportunity to provide students with *international human capital* and the ability to *network and build connections*. In addition, the role of time in decision-making is a cost faculty must consider.

### Introduction

A widespread push exists to globalize and internationalize undergraduate curriculum at U.S. institutions of higher education. As global economies and societies become increasingly interdependent, graduates and organizations in the food, agriculture, natural resources, and related sciences must be prepared (Andreasen, 2003; Harder, Lamm, Roberts, Navarro, & Ricketts, 2012; Lamm & Harder, 2010; Roberts, Rodriguez, Gouldthorpe, Stedman, Harder, & Hartmann, 2016; National Research Council [NRC], 2009). Colleges of agriculture across the U.S. have been challenged to provide an internationalized curriculum that prepares students for employment in the global food and agriculture marketplace after graduation (NRC, 2009). The NRC's mission to achieve this goal is twofold: 1) increase international experiences for students and 2) integrate international content into on-campus curriculum (Harder et al., 2012). However, to accomplish the task of internationalizing the curriculum, it is imperative that universities "internationalize the faculty" who work at them (Dooley & Rouse, 2009, p. 48).

High impact learning experiences are considered a way faculty can prepare university graduates for employment (Murphrey, Odom, & Sledd, 2016). High impact learning experiences in the fields of agriculture encourage students to "purposefully and systematically . . . create new knowledge, make connections across curriculum, explore opinions/views/perspectives beyond their own, and engage in critical thinking" (Murphrey et al., 2016, p. 162).

Kuh (2008) identified diversity and global learning as an example of a high-impact activity that could sharpen students' critical thinking abilities. Future graduates of university agriculture programs need to demonstrate a high level of global competence (Platt, 2004). These needs can be met in a number of ways, such as students' participation in study abroad programs (Roberts et al., 2016). Scholars believe international experiences, such as study abroad, help students

develop such skills (Bruening & Shao, 2005). However, the vital importance and role faculty play in developing and facilitating such experiences must not be lost in this discussion.

Although study abroad programs have varied in length over the past 25 years, “Skepticism has been voiced about whether the increasingly popular short-term study abroad format can offer students a sufficiently profound experience to transform the fundamental values and beliefs that underlie global citizenship” (Tarrant, Rubin, & Stoner, 2013, p. 6). Harder et al. (2012) identified college faculty as a key factor in the pursuit of internationalizing content in on-campus courses, and concluded faculty must be globally competent if they are to actively participate in the internationalization process. To this end, college faculty are expected to gain international experience to globalize educational experiences for students (Gouldthorpe et al., 2012). However, various challenges make opportunities for faculty to participate in international experiences difficult (Moseley, 2009), which emphasizes the importance of understanding what motivates faculty to achieve this goal. Overcoming barriers to gaining global competence requires faculty to be sufficiently motivated to seek out and ascertain international experience of their own. Professional development opportunities exist to increase these skills (Gouldthorpe et al., 2012; Roberts et al., 2016). For students, faculty-led international experiences are the most popular option for students looking to increase their global competence and awareness (Bunch, Lamm, Israel, & Edwards, 2013; Ludwig & McGirr, 2003; Zhai & Scheer, 2002).

College faculty play an important role in developing students’ global competence and awareness, whether through on-campus courses or international experiences. Faculty must be able “to deliver international pedagogy that develops students with an understanding of the cultural, social, economic, and political systems throughout the world” (Sjoberg & Shabalina, 2010, p. 46). Planning, developing, and leading a study abroad trip is a time consuming task (Koernig, 2007) and, due to their heavy workload pressures and expectations, one that should be thought through and considered carefully for those who are untenured (Dooley, Dooley, & Carranza, 2008). Some faculty are expected to become bilingual to lead a study abroad trip adequately (Sjoberg & Shabalina, 2010). Therefore, what is the motivation for a faculty member to conduct a short-term study abroad experience?

Faculty motivation to internationalize curriculum is most likely impacted by past international experiences. Therefore, it is important to understand faculty’s past experiences and motivations to increase global competence and awareness to understand the impact they might have on students’ experiences. Given the importance that faculty motivation has in shaping students’ experiences, a need exists to understand how faculty conceptualize their motivations to lead the effort in internationalizing college curriculum. Such an inquiry could lead to developing faculty profiles of individualized international experience for students to better identify the type of experience they wish to participate. Despite the importance of globally competent and aware faculty, our research found limited inquiries regarding their motivations to facilitate international experiences for students – a pathway to internationalizing content for on-campus courses vis-à-vis increased global competence and awareness as a result of leading a study abroad program.

Although faculty who lead study abroad trips tend to be more *global* in their teaching than their counterparts who refrain from leading study abroad courses, additional work should determine the impact of such experiences on how and why faculty teach the way they do (Sandgren, Ellig,

Hovde, Krejci, & Rice, 1999). It is imperative, from a motivational standpoint, to identify the expectations faculty have regarding study abroad experiences (Harder et al., 2012).

### **Theoretical Framework**

This study was assessed through the lens of motivation. Motivation to lead an international experience, such as a study abroad program, from an expectancy-value perspective, results from the alignment of expectancies for success, subjective task values, and perceived costs of participation. We identified expectancy-value theory (EVT) as the most appropriate theoretical lens for understanding and describing how faculty in the College of Agricultural Sciences and Natural Resources (CASNR) at Oklahoma State University experienced motivation to facilitate international learning experiences for students.

Modern EVT is grounded in the seminal work of Atkinson (1964), linking achievement behaviors, persistence, and choice to individuals' expectancy- and ability-related beliefs and subjective-task value beliefs (Eccles & Wigfield, 2002). Modern expectancy-value theory includes a broad array of determinants, including the psychological, social, and cultural aspects of individuals' choices to engage in tasks. Eccles et al. (1983) operationalized expectancies for success as individuals' beliefs regarding future performance on an upcoming task, which are measured in manners analogous to Bandura's (1997) self-expectations for success. *Expectancies for success* are ability-related beliefs regarding personal capabilities in the context of performing a task successfully. In colloquial terms, they answer the question, "Can I successfully lead a short-term study abroad course?" (Schunk et al., 2013). Values pertain to individuals' perceptions about why they might choose to engage in a task. They answer the question, "Do I want to lead a short-term study abroad course and why?" (Schunk et al., 2013). *Subjective-task value* is a universal construct defined by four distinct domains: attainment value, intrinsic value, utility value, and cost (Eccles et al., 1983). *Attainment value* is operationalized as the personal importance of succeeding on a task as well as explaining the reason one engages in a task. Individuals use this value to confirm or demonstrate aspects of personal ideals of self-schema, such as masculinity and femininity (i.e., the opportunity to demonstrate competence in a certain domain or task). Individuals hold higher attainment values for activities to the extent they can demonstrate or confirm positive aspects of those schemata (Eccles & Wigfield, 2002). *Intrinsic values* are the enjoyment of activity participation and interest in the activity or task, while *utility values* relate to a person's futures goals and relative cost relates to the negative aspects of task engagement (Eccles & Wigfield, 2002). *Cost* has been recognized an additional dimension to expectancy-value models and can impact whether or not a person chooses to participate in a task (Barron & Hulleman, 2014; Flake, Barron, Hulleman, McCoach, & Welsh, 2015).

### **Context and Overview**

In 2015, Oklahoma State University set a goal of having one-half of all of its undergraduate students participate in an international experience prior to being graduated. In addition, this plan seeks to recognize and promote internationalism of students, faculty, and staff and increase international capabilities of faculty and staff. International experiences offered to students at Oklahoma State University vary from short-term, faculty-led programs to semester and academic year programs (reciprocal exchange). The university believes there is transformational power in

having an internationalized campus, including the benefits that it can provide to the scholars residing there (Oklahoma State University International Strategic Plan, 2015). Part of the plan requires university employees be rewarded for their international efforts and supported by programs to better understand the university's international strategic mission.

### **Purpose**

Given the numerous questions surrounding the value of short-term study abroad courses or experiences, this case study used the conceptual lens of expectancy-value theory to investigate the motivations of four college faculty in the CASNR at Oklahoma State University for leading such experiences. Specifically, this study sought to answer the following research question: What motivates faculty members at a land-grant university to develop and lead a short-term study abroad course or experience? This study aligns with Research Priority 4: Meaningful, Engaged Learning in All Environments (Roberts, Harder, & Brashears, 2016).

### **Method and Procedures**

#### **Research Design**

A qualitative, case-study design was selected because it is most suited for controlling researcher bias and isolating the phenomenon under investigation. In case-study research, the researcher attempts to gain access to the lived experiences of a phenomenon (Stake, 1995). The dearth of information in the literature regarding faculty motivations to lead international experiences provides the impetus for exploring the *how* and the *why*. It is only through their lived experiences that the story can begin to be unfolded. To do this, a qualitative approach (Patton, 2015) was used to understand better the motivations agricultural faculty assign to their shared experiences leading short-term study abroad courses or experiences.

We used criterion-based sampling to identify participants for the study. Criterion-based sampling involves selecting participants based on pre-determined metrics of importance (Patton, 2015). In this study, participants met the following criteria: 1) must be active faculty members in the CASNR at Oklahoma State University, 2) must lead a short-term, study abroad course or experience as a result of their teaching expectations, and 3) must be willing to engage in the interview process, including follow-up interviews.

Potential participants were located through the university directory of colleges with short-term study abroad courses or experiences. The frame was cross-referenced with a list of participants from the CASNR at Oklahoma State University. We contacted faculty directly through email. Participants were interviewed face-to-face in an open-ended interview in their individual university offices using a researcher designed interview protocol. The overall intent of the interview protocol was to be flexible and emergent (Patton, 2015). However, in general, faculty were asked to 1) provide an overview of their academic background; 2) discuss the development of their study abroad course, such as how they developed it, how they chose their destination, and how they established their contacts and experiences; 3) explain how they became aware of the opportunity to lead short-term study abroad courses; 4) discuss their personal and professional motivations for leading a study abroad experience; 5) reflect on what they hope

students gain from the experience, and 6) to offer policy recommendations for the university's study abroad office. The duration of the interviews ranged from 44 minutes to 55 minutes.

Interviews were transcribed verbatim and analyzed using the constant comparative method. This method looks for linkages within the data to identify patterns and themes (Merriam, 1998). Pseudonyms were assigned to each participant to protect individual identity. The results of the study were grouped by the research question and broken down by emergent theme and sub-themes (Lincoln & Guba, 1985). The two researchers served as the instruments for the study (Guba & Lincoln, 1989) and as such, met weekly to discuss the interviews and analysis. Member checking and triangulation were used to increase the internal validity and reliability of the study (Lincoln & Guba, 1985; Merriam, 1998). An audit trail was established to ensure the study's dependability and credibility (Trochim, 2006). Confirmability was established during the coding process as data were analyzed line-by-line, and themes were developed regarding repetitive words, statements, and phrases (Patton, 2015). In addition to interviews from the protocol, course syllabi and personal curriculum vitae were referenced to triangulate the data. Peer examination, and detailed accounts of participant experiences were used to increase the trustworthiness and credibility of the inquiries.

A critical element in conducting qualitative research is to acknowledge the bias that individual researchers have toward the phenomenon, which ultimately could affect the interpretations of the study. As such, we offer the following reflexivity statement to describe our bias and interest in the topic (Lincoln & Guba, 1985). *The first researcher is a third-year Ph.D. student in Agricultural Education. He is a Returned Peace Corps Volunteer and lived abroad for three years. His research focuses on human motivation and role of perceived cost in decision-making in agricultural and natural resource settings. The second researcher is a professor of Agricultural Education who was a secondary agricultural education teacher for three years. As a professor, he has made several trips abroad and has delivered professional development to agriculturists on best practices related to raising livestock and conservation farming. His research is underpinned in human capital and motivation.* Based on these experiences, we recognize our influence on the study's findings; however, measures were taken to lessen our bias when interpreting the data and drawing conclusions.

## **Participants**

The population of this study consisted of all CASNR faculty ( $N = 4$ ) at Oklahoma State University who led a study abroad experience in 2016. Of the four professors, one was female and three were males. A description of each participant's personal and professional profile is included below.

*Dr. Talley* is a professor in agricultural education. He has been recognized and awarded by his peers as an outstanding teacher multiple times at the university, regional, and national levels. At a former university, Dr. Talley was awarded the highest teaching honor possible. He is a teacher educator, and his research fits within the scholarship of teaching and learning. He serves on numerous teaching-related committees at the college level and prides himself on being an excellent teacher. At his former institution, Dr. Talley was employed on a 100% teaching appointment, and even now that he serves as an administrator, he continues to teach and advise

graduate and undergraduate students. He has led a study abroad course to Europe for the past eight years.

*Dr. Lee* is an assistant professor in horticulture. She is employed on an 80% teaching and 20% extension appointment. A native of China, Dr. Lee appreciates the expertise her home country offers regarding landscape design and architecture. Prior to entering the professoriate, Dr. Lee worked in landscape design for 17 years in China. In addition to teaching a full load, she delivers numerous extension programs each year to adults and youth alike. As listed in her curriculum vitae, 67% of her peer-reviewed research publications include *pedagogy* and *motivation* in the titles, indicating further her desire to be an effective teaching scholar.

*Dr. Kutcher* is a professor in forestry. He is employed on a 100% teaching appointment. Per his curriculum vitae, he has received 17 awards related to his teaching, including but not limited to, the College's Teaching Excellence Award, the University Regents Distinguished Teaching Award, and the Faculty Excellence Award in International Studies. Additionally, he has been recognized as a Fellow in his discipline. Dr. Kutcher served as his department's undergraduate curriculum coordinator for 13 years and actively advises undergraduate students. He teaches eight courses and coordinates two three-week international field camps each year for students.

*Dr. Schuster* is a professor in agricultural economics. He is employed on a 100% teaching appointment where he teaches undergraduate students about economics principles and finance. Per his curriculum vitae, he has been recognized with seven teaching and eight advising awards during his tenure. Dr. Schuster has served on numerous college- and university-wide committees, including the representative for the General Education Committee for the CASNR, the Agricultural Faculty Council, and the Academic Standards Committee.

## Findings

The first part of objective one dealt with what motivated faculty to develop a study abroad course. Through our analysis of the data, three themes and seven subthemes emerged: *confidence building*, *student inspirations*, and *pre-existing structure*. Emergent themes and sub-themes regarding faculty's motivation to develop study abroad courses have been highlighted in Figure 1, and descriptions of the themes and subthemes follow in the text below.

### Theme 1: Confidence Building

Dr. Talley framed initial motivations for leading short-term study abroad courses with comparisons to previous international experiences, as a form of confidence building. He qualified these statements with the phrase, "I had no idea what I was getting into at first." He also compared topics such as challenges, culture shock, and language barriers to what he perceived would "build confidence." Overall, Dr. Talley believed the language barriers and culture of Czech Republic would be a good fit for "kids who hadn't studied abroad before or didn't have any previous international experience." Dr. Kutchar admitted that developing a study abroad course was nowhere on his radar when he first entered the professoriate. In fact, when he began his tenure, there were only a few faculty involved in study abroad. Yet, he was able to build his confidence only after he made his first trip to Honduras alone to survey the landscape.

On returning, he was convinced to “make this work somehow” and became an early pioneer for developing a study abroad course. Dr. Lee hinted that her confidence in developing a study abroad course to China stemmed from her frequent international travel back and forth from the US to China, her home country. By building their confidence, these instructors improved their self-efficacy to travel internationally, which helped them understand the barriers students might encounter later with traveling abroad. The experiences also helped them understand how to navigate students’ potential for culture shock when traveling to a new location for the first time.

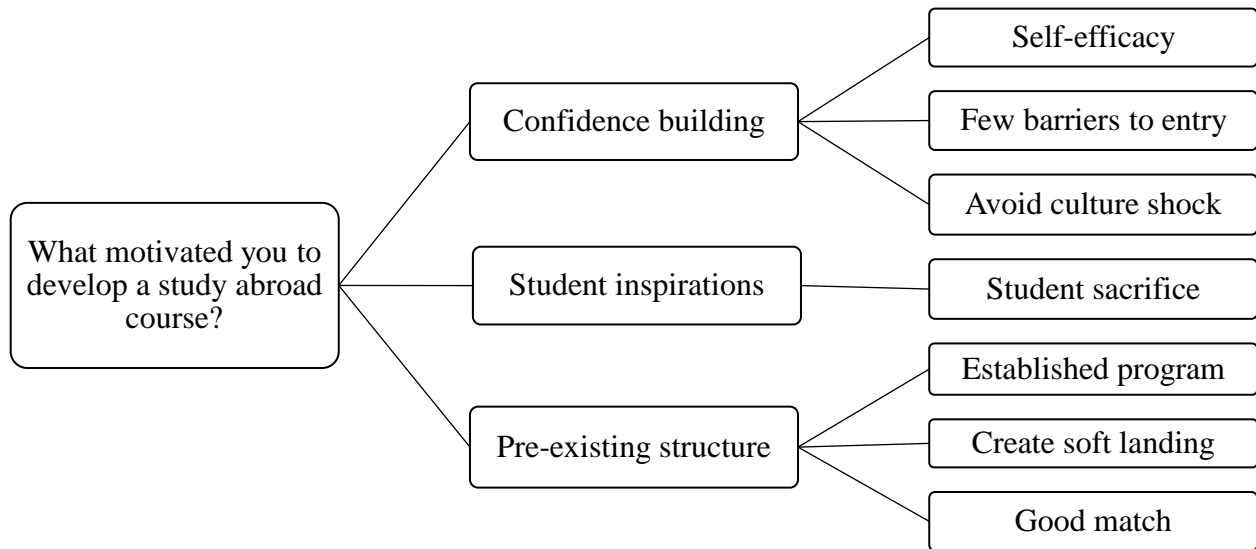

Figure 1. Themes and subthemes emerging from participants’ responses to a question about their initial motivations for developing a study abroad course.

## Theme 2: Student Inspirations

Faculty were motivated to develop their study abroad courses because of specific students who inspired them to do so. Dr. Kutcher stated that 27 years ago two students from Honduras knocked on his door and introduced themselves to him. They both had technical degrees from Honduras and were at Oklahoma State University on a grant-funded program with the hope of becoming foresters and returning to Honduras after receiving their degrees. At the end of their academic careers, they invited Dr. Kutcher to their homeland to visit them. Their persistence prevailed as they continued to handwrite him personal invitation letters each month until he finally agreed to travel to Honduras to meet up with them. As a result of that invitation and persistence, a study abroad course emerged, and he took his first cohort of students to Honduras in 1999.

Dr. Lee shared a similar story about being “moved” by one of her students. Although he had never taken out a student loan to pay for any part of his education, he was willing to do so to participate in her study abroad course. The student was adamant that he attend. He perceived it to be a “once in a lifetime opportunity.” Because of this student’s persistence and willingness to sacrifice by going into financial debt, Dr. Lee was “determined” to develop the course.

### Theme 3: Pre-existing Structure

Being able to benefit from an established program with a pre-existing structure was a motivation for faculty (see Figure 1). Dr. Schuster stated that he was the beneficiary of a study abroad experience that had been delivered by another faculty member before him. In fact, he admitted that although he and his colleague co-developed the syllabus, it was his colleague who had been the one to travel and deliver the course. Toward the end of his colleague's tenure and pending retirement, Dr. Schuster was invited to accompany him on his last trip to get a *lay of the land* and receive mentorship. During that trip, Dr. Schuster met contacts, observed his colleague teach the course, and surveyed the sights necessary for leading the course effectively in the future.

Dr. Lee told a similar story of how when she was hired, the person who preceded her was known as the *study abroad faculty member* in her department. She stated that once the faculty member retired, the study abroad experiences stopped in her department. After "four or five years" of dormancy, Dr. Lee was encouraged by a colleague to consider reviving the experience for students. She admitted, "It (study abroad experience) was just nice to be picked up again as a department tradition." Having an *established program* in place made the transition smoother.

In addition to having an established program, a sub-theme of *creating a soft landing for students* emerged within the *pre-existing structure* theme. The impact that an established program could have on students with no prior international experience was noted in Dr. Talley's comments such as, "I wanted to do something that wouldn't be too much of a culture shock, so a developed part of the world, but would still have challenges for them." As such, he believed his country of choice in Europe would be a "pretty good match" for them.

The second part of objective one dealt with what motivated faculty to lead a study abroad course. Two themes and five subthemes emerged when analyzing faculty's motivations for leading a study abroad course or experience: *build international human capital* and *connectivity and networking*. The *building international human capital* theme was further broken out into three subthemes: *global awareness*, *diversity appreciation*, and *intercultural competence*. The *connectivity and networking* theme included the subthemes *lifelong friends* and *professional opportunities*. The emergent themes and sub-themes have been highlighted in Figure 2, and descriptions of the themes and subthemes follow in the text below.



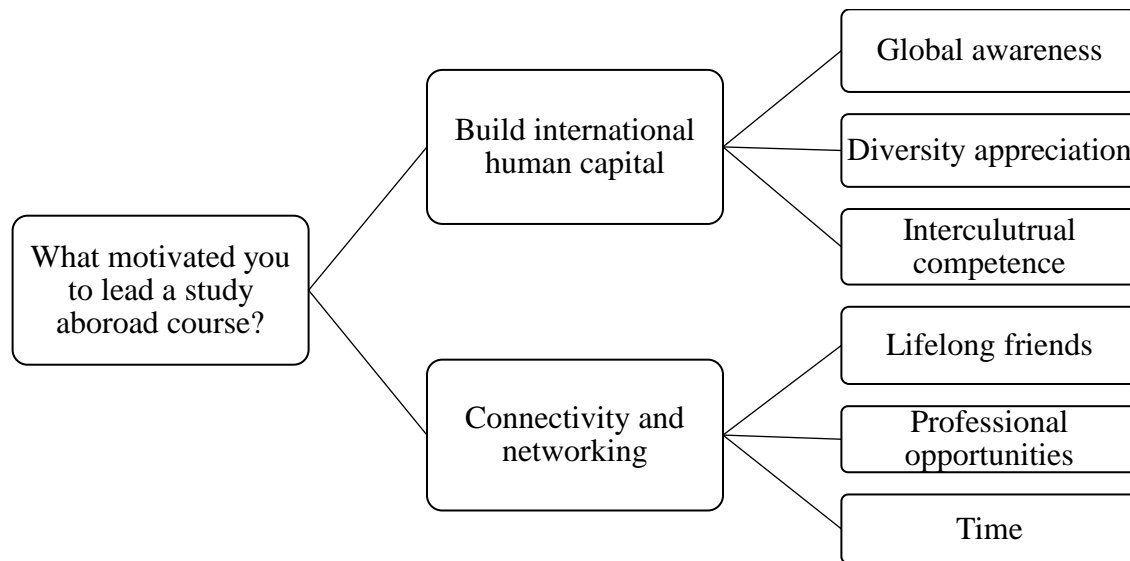

Figure 2. Themes and subthemes emerging from participants' responses to a question about initial motivations for leading study abroad courses.

### Theme 1: Build International Human Capital

As for using study abroad to acquire specific agricultural content knowledge, Dr. Lee admitted that China is known for some of the world's best and most intricate landscape architectural designs, and that is one reason she chooses to take students there each year. However, her main objective is to allow students to "see the world and open up their horizons – to make them think anything's possible instead of everything being super practical." Dr. Schuster took it a step further by admitting that he "didn't do a lot of agriculture" on his study abroad experiences. For him, the experience is less about the ability to see agriculture and more about the opportunity to observe a different way of life. In fact, sometimes being exposed to agriculture, such as visiting "a real farm" or "a sheep experiment station" can cause problems with reentry into the US. As such, for him, it is easier to refrain from participating in these types of activities. Instead of acquiring specific knowledge in technical agriculture, the theme *build international human capital* is comprised of the statements made about helping students become globally aware, appreciative of diversity, and competent in and sensitive to intercultural relations.

Dr. Schuster explained: "The big thing is getting students comfortable outside their comfort zone [and] eating food that they've not really ever thought about eating." For Dr. Kutcher, it is bigger than just the food they may or may not have thought about eating. He stated, "There's a lot of things that unite us and make us similar, but there's a ton of things that make us different. We are not all the same. I can talk to you about the uniqueness of other peoples and places, but there's nothing like being there." Dr. Talley expected students to create a "ripple from their experience with the students they work with as they go to rural Oklahoma" and use these experiences as an "opportunity to expose students to a different culture."

*Global awareness* was a subtheme for the *build international human capital* theme. Faculty discussed the power that traveling abroad had on creating rich, meaningful, and relevant learning

experiences. When discussing student learning, Dr. Kutcher stated, “I can’t sit in a classroom and make that happen as well as I can on a mountaintop in another country at four in the morning when the suns’ coming up.” Study abroad experiences allow faculty to cultivate richer and deeper learning and serve as a “benchmark” of students’ lives that they will reflect on forever.

Part of what comprised the global awareness subtheme is students’ ability to navigate transportation systems. Dr. Schuster expressed that some students have never left the state, much less traveled internationally. His goal is to increase their confidence in traveling to a large international city, navigating the airport, and conquering the bus and subway systems so that they can feel confident in traveling again in the future if and when their careers or lives mandate that.

Although sight seeing is an important component of traveling internationally, it is not driving force behind leading an international study abroad experience. Dr. Kutcher explained that most people who travel to Central America want to see “two or three grand things,” such as the Mayan Ruins or Machu Picchu and “then they go home.” Although he also wants his students to see these tourist attractions, he admits he is after “a different kind of tourism.” He desires for them to “live in a village” and “home stay with some families.” It is through these intimate interactions that students begin to understand and *appreciate diversity* on a deeper level.

Not being able to speak the native language can be a barrier regarding a person’s *intercultural competence*. However, faculty admitted to dealing with the language barrier in different ways. For Dr. Lee, a natural born citizen of China, the Chinese language is not an issue. She stated, “I can speak the language.” However, others are not so fortunate. Faculty some must navigate and overcome the language barrier to be efficient and effective depending on their location. Dr. Kutcher explained that he was so adamant about Central America when he began developing his course that he enrolled in and completed two semesters of Spanish. He stated,

I was in my 40s when I sat in there with a bunch of 19-year olds and took two semesters of Spanish. I was committed. I was getting up at four in the morning to review my Spanish. Today, I can go to a Latin America country, South or Central America, and I can survive. My Spanish is good enough.

For Dr. Kutcher, overcoming the language barrier is more about interpretation and observation. He did not perceive traveling internationally to be a problem, “even if English is not the first language.” He explained that through observing signs and people, it is possible to overcome the language barrier.

## **Theme 2: Connectivity and Networking**

When analyzing the interview data regarding faculty’s motivation for leading study abroad experiences, a theme that constantly emerged was *connectivity and networking* through helping students build lifelong community and relationships. Dr. Schuster explained that he seeks to encourage students to interact with people who are vastly different than them. Part of the interaction requires having an appreciation for the differences and similarities they share with others. Dr. Kutcher explained,

There's a cultural story and you don't know those stories unless you live those stories. You got to go to the source of the culture. When you can make that connection and that tie, people will do anything for you.

He stated further,

I look for opportunities to get into the real fabric of the land, get to know people on a personal level, be accepted by these people, then all of a sudden bridges are built, doors are opened, stereotypes are left to the side.

Being open to learning a new culture increases students' appreciation for diversity, which was recognized as a subtheme. Dr. Talley discussed hopes for students to stay connected with the people they meet. He also was motivated by a desire to have students "get to know the faculty that go on the trips with them" and having "kids go on this trip and then follow it up with a trip to the developing world." Dr. Lee's course, helps students connect by purposefully pairing together US and China students to work on problems related to landscape design to allow "cultural exchange" to occur. Through interactions such as these, connectivity increase. What is more, each of these faculty discussed the role time played in networking and building connectivity necessary to lead study abroad experiences. They all agreed that time would be the greatest prohibitor for faculty members who carry a lesser teaching appointment.

### **Conclusions**

The purpose of this study was to explore faculty motivations for developing and leading short-term study abroad courses or experiences. The respondents were asked to describe their motivations for leading short-term, study abroad courses or experiences and indicate what they expected students to gain from the international experience. *Confidence building, student inspirations, and pre-existing structures* were the three themes that emerged regarding faculty's motivation for developing study abroad courses. Faculty admitted that before they were able to develop their course, they had to build their own confidence first. Faculty achieved this in multiple ways. One traveled solo to his destination of choice to meet with former students and have them show him around the country. Another chose to travel to her home country, in part, because of her confidence in and familiarity with navigating the destination. The remaining two faculty used a pre-existing structure to plan out and orchestrate the experiences. One traveled along with the faculty member who was leading the course at the time to learn the names of the contacts and mentor under the guidance of the outgoing instructor. The general consensus was that faculty wanted to increase their confidence so they could increase the students' confidence. In multiple instances, faculty responded that their students were the motivating force behind their decision to attempt study abroad.

Regarding their motivation to lead a study abroad course, two major themes emerged: *build international human capital* and *connectivity and networking*. The notion of increasing faculty members' international human capital is imperative for "internationalizing the university" (Dooley & Rouse, 2009, p. 48). Multiple instances, faculty discussed the importance of helping students build their global awareness. The skills, knowledge, and experiences students gain from faculty-led study abroad courses can improve future relations with people who are different than them. This finding coincides with research conducted by Dooley et al., (2008) who concluded that for international collaboration to occur in the future, faculty must establish personal relationships with cultures different than their own. Faculty acknowledged that they wanted to

show students the agriculture that existed in the country they were visiting; however, using study abroad as a tool for teaching agriculture was not the driving force behind going. What was more important was that students experienced another culture.

In addition, when assessing motivation through an expectancy-value lens (Eccles et al., 1983), the time necessary to plan and lead a study abroad course emerged as a cost factor for faculty (Flake et al., 2015). Each faculty member was employed on a heavy teaching appointment and recognized that time could be a barrier to those who were not yet tenured or had heavy research appointments. This finding aligns with research by Dooley et al. (2008) who discovered that assistant professors who were attempting to achieve promotion and tenure were the group of faculty who were affected most by leading study abroad experiences due to their heavier workload constraints and expectations.

### **Discussion, Implications, and Recommendations**

It can be implied the faculty featured in this study have a desire to leave a lifelong impression on their students. They are willing to invest multiple hours of preparation on the course, travel halfway around the world to visit remote areas, and sacrifice time away from their families to help make learning meaningful and lasting for their students. Although the same could be said for numerous faculty, the four featured in this study were willing to go to extremes to make that happen. Because these faculty have heavy teaching appointments, they have been able to spend years perfecting their courses. Not every faculty member has this luxury. Why were there only four CASNR faculty willing to lead study abroad programs at Oklahoma State University in 2016? Is it possible that the expectations for conducting scholarship demotivate some faculty from leading study abroad programs? Professional development opportunities should exist for CASNR faculty who may be interested in developing and leading study abroad experiences but are not currently (see Roberts et al., 2016; Dooley et al., 2008). Special emphasis should be placed on helping faculty collect data on the impact such a course has on student learning and using it to satisfy part of a faculty member's research expectation. If Oklahoma State University expects to reach its goal of having one-half of its student body participate in study abroad experiences, additional faculty will have to be recruited and prepared. Therefore, providing faculty members, such as the ones featured in this study, a forum for which they can share their stories with and mentor prospective faculty who are interested in developing and leading a study abroad course is an imperative task to consider.

In the future, trip organizers can use this information as a planning tool to help develop international experiences for students before, during, and after the trip. Results of this inquiry revealed specific beliefs of these faculty members regarding how international experiences should be designed and implemented, including expected outcomes. Responses to the question about the initial impetus for leading a short-term study abroad course revealed a tendency to build the respondent's confidence and provide students a homophilic experience.

The current study adds to the literature on the prohibitors and motivators of faculty in food, agriculture, and natural resources. However, this topic has not yet been examined in sufficient detail to provide a complete understanding of the phenomenon. Additional research is warranted with other faculty in food, agriculture, and natural resources before, during, and after they lead a

short-term study abroad course or experience (Dooley et al., 2008). A few questions resulting from the study include the following: How do affective memories of faculty regarding international experiences influence course delivery? How does this influence geographical setting? Are there observable differences between affective memories of international experiences and course requirements?

Three of the four faculty interviewed in this study were tenured at the rank of full professor. In addition, these faculty carry a heavy teaching load with three of the four having an 80% teaching appointment or higher. Interestingly, none of them currently have, nor have ever had, a research appointment. Thus, the expectation is for them to focus on being excellent teachers. This suggests time and effort might be critical components underpinning faculty motivations to facilitate international experiences for students (Barron & Hulleman, 2014; Flake et al., 2015). Unfortunately, not all faculty have the luxury of planning and delivering study abroad opportunities due to their faculty appointments. In this case, the *outside effort cost* and *loss of valued alternatives cost* might be the most significant prohibitor regarding faculty motivations to develop and lead short-term study abroad courses (Barron & Hulleman, 2014; Flake et al., 2015). It is clear that time is a necessity for establishing quality study abroad experiences. It takes time to be able to plan, deliver, and assess such high impacts learning opportunities (Kuh, 2008).

## References

- Andreasen, R. J. (2003). Barriers to international involvement. *Journal of International Agriculture and Extension Education*, 10(3), 65–69. doi:10.5191/jiaee.2003.10308
- Atkinson, J. W. (1964). *An introduction to motivation*. Princeton, NJ: Van Nostrand.
- Bandura A. 1997. *Self-Efficacy: The exercise of control*. New York, NY: Freeman.
- Barron, K. E., & Hulleman, C. (2014). Expectancy-value-cost model of motivation. In J. S. Eccles & K. Salmelo-Aro (Eds.), *International Encyclopedia of Social & Behavioral Sciences, 2nd edition: Motivational Psychology*. Elsevier.
- Bruening, T.H., & Shao, X. (2005). What should be included in an international agriculture undergraduate course? *Journal of International Agricultural and Extension Education*, 12(1), 47–54. doi:10.5191/jiaee.2005.12105
- Bunch, J. C., Lamm, A. J., Israel, G. D., & Edwards, M. C. (2013). Assessing the motivators and barriers influencing undergraduate students' choices to participate in international experiences. *Journal of Agricultural Education*, 54(2), 217–231. doi:10.5032/jae.2013.02217
- Dooley, K. E., Dooley, L. M., & Carranza, G. (2008). Beliefs, barriers, and benefits of a faculty abroad experience in Mexico. *Journal of International Agriculture and Extension Education*, 15(3), 29–38.
- Dooley, K. E., & Rouse, L. A. (2009). Longitudinal impacts of a faculty abroad program: 1994–2007. *Journal of International Agricultural and Extension Education*, 16(3), 47–58. doi:10.5191/jiaee.2009.16305
- Eccles, J. S., Adler, T. F., Futterman, R., Goff, S. B., Kaczala, C. M., & Meece, J. (1983). Expectancies, values and academic behaviors. In J. T. Spence (Ed.), *Achievement and Achievement Motives*, 75–146. San Francisco, CA: W. H. Freeman.
- Eccles, J. S., & Wigfield, A. (2002). Motivational beliefs, values, and goals. *Annual Review of Psychology*, 53(1), 109–132. doi:10.1146/annurev.psych.53.100901.135153
- Flake, J. K., Barron, K. E., Hulleman, C., McCoach, B. D., & Welsh, M. E. (2015). Measuring cost: The forgotten component of expectancy-value theory. *Contemporary Educational Psychology*, 41(2015), 232–244. Retrieved from <https://doi.org/10.1016/j.cedpsych.2015.03.002>
- Gouldthorpe, J. L., Harder, A., Stedman, N., & Roberts, T. G. (2012). Steps toward internationalization in undergraduate programs: The use of prelective activities for faculty international experiences. *Journal of International Agricultural and Extension Education*, 19(1), 30–41. doi:10.5191/jiaee.2012.19105

- Guba, E. G. & Lincoln, Y. S. (1989). *Fourth generation evaluation*. Newbury Park, CA: Sage Publications, Inc.
- Harder, A., Lamm, A., Roberts, T. G., Navarro, M., & Ricketts, J. (2012). Using a pre-reflective activity to identify faculty beliefs prior to an international professional development experience. *Journal of Agricultural Education*, 53(4), 17–28. doi:10.5032/jae.2012.04017
- International Strategic Plan. (2015). Retrieved from <https://next.oklahomastateuniversity.edu/>
- Koernig, S. K. (2007). Planning, organizing, and conducting a 2-week study abroad trip for undergraduate students: Guidelines for first-time faculty. *Journal of Marketing Education*, 29(3), 210–217. doi:10.1177/0273475307306886
- Kuh, G. D. (2008). High impact educational practices: What they are, who has access to them, and why they matter. Washington, DC: *Association of American Colleges and Universities*.
- Lamm, A., & Harder, A. (2010). Don't drink the water: Recognizing the fears associated with international extension work. *Journal of International Agricultural and Extension Education*, 17(3), 31–41. doi:10.5191/jiaee.2010.17303
- Lincoln, Y. S., & Guba, E. G. (1985). *Naturalistic inquiry*. Beverly Hills, CA: Sage Publications.
- Ludwig, B. G., & McGirr, M. J. (2003). Globalizing Extension – A nation initiative for U.S land grant universities. *Proceedings of the 19th Annual Conference of Association of International Agricultural and Extension Education, Raleigh, NC*, 401–411. Retrieved from <https://www.aiaee.org/attachments/article/1200/Ludwig401.pdf>
- Merriam, S. B. (1998). *Qualitative research and case study applications in education*. San Francisco, CA: Jossey-Bass.
- Moseley, W. G. (2009). Making study abroad a win-win opportunity for pre-tenure faculty. *Frontiers: The Interdisciplinary Journal of Study Abroad*, 18, 231–240. Retrieved from <http://files.eric.ed.gov/fulltext/EJ883701.pdf>
- Murphrey, T. P., Odom, S. F., & Sledd, J. (2016). An examination of university agricultural education faculty attitudes toward the implementation of high impact learning experiences. *Journal of Agricultural Education*, 57(3), 162–179. doi:10.5032/jae.2016.03162
- National Research Council. (2009). *Transforming agricultural education for a changing world*. Washington, DC: National Academies Press.
- Patton, M. Q. (2015). *Qualitative research & evaluation methods (4th ed.)*. Thousand Oaks, CA: Sage Publications, Inc.

- Platt, (2004). *Make global skills a top priority*. USA Edition of the Financial Times Limited. London, England.
- Roberts, T. G., Harder, A., & Brashears, M. T. (Eds). (2016). *American Association for Agricultural Education national research agenda: 2016-2020*. Gainesville, FL: Department of Agricultural Education and Communication.
- Roberts, T. G., Rodriguez, M. T., Gouldthorpe, J. L., Stedman, N. L., Harder, A., & Hartmann, M. (2016). Exploring Outcomes Two Years after an International Faculty Abroad Experience. *Journal of Agricultural Education*, 57(10), 30–41. doi:10.5032/jae.2016.01030
- Sandgren, D., Ellig, N., Hovde, P., Krejci, M., & Rice, M. (1999). How international experience affect teaching: Understanding the impact of faculty study abroad. *Journal of Studies in International Education*, 3(1), 33–56. Retrieved from <http://journals.sagepub.com/doi/pdf/10.1177/102831539900300104>
- Schunk, D. H., Meece, J. R., & Pintrich, P. R. (2013). *Motivation in education: Theory, research, and applications (4th ed.)*. New York, NY: Pearson.
- Sjoberg, S. D., & Shabalina, O. I. (2010). More than a sight-seeing trip: Enhancing the value in short-term study abroad. *Business Education Innovation Journal*, 2(2), 46–58. Retrieved from [http://bejournal.com/images/BEIJ\\_V2N2\\_Dec2010text.pdf#page=46](http://bejournal.com/images/BEIJ_V2N2_Dec2010text.pdf#page=46)
- Stake, R. E. (1995). *The art of case study research*. Thousand Oaks, CA: Sage Publications, Inc.
- Tarrant, M. A., Rubin, D. L., & Stoner, L. (2013). The added value of study abroad: Fostering a global citizenry. *Journal of Studies in International Education*, 18(2), 141–161. doi:10.1177/1028315313497589
- Trochim, W. (2006). *Qualitative validity*. Retrieved from <http://www.socialresearchmethods.net/kb/qualval.php>
- Zhai, L., & Scheer, S. D. (2002). The influence of international experience on agriculture student personal development. *Journal of International Agricultural and Extension Education*, 9 (3), 23–29. doi:10.5191/jiaee.2002.09303



## **Examining Cultural Proficiency Among Secondary Agricultural Education Youth Through Intercultural Effectiveness and Global Experiences**

Mrs. Kendall M. Wright, University of Kentucky  
Mrs. Courtney A. Turley, University of Kentucky  
Dr. Stacy K. Vincent, University of Kentucky

### **Abstract**

*This study evaluated the impact varying amounts of global exposure and previous travel experiences have on secondary agriculture students' intercultural effectiveness and global experiences through the Mere Exposure Theory. Using a descriptive correlational approach, the researchers surveyed 387 secondary agriculture students from 11 schools in [STATE] to evaluate participant self-awareness, exploration, global mindset, relationship interest, positive regard, and emotional resilience. Findings revealed the majority of participants excelled in exploration and lacked in global mindsets. Furthermore, the majority of participants represented a homogeneous population, indicating agricultural educators should take action to increase their level of cultural competence and intercultural effectiveness and continue to incorporate cultural activities and conversations in their curriculum, which will aid in recruitment of diverse students to their program.*

### **Introduction**

An increasingly diverse population coupled with constant advances in technology results in the world growing smaller and smaller with each passing day. An enormous shift in the American population's diversity is evidenced by each passing census. The U. S. Census Bureau (2012) projects that the United States may become a majority-minority nation for the first time in 2043. As the population makeup steadily continues to shift, so will the exposure to different cultures. One of the most impactful places of cultural exposure is within classrooms across the United States and this exposure plays a key role in developing global mindsets and awareness of a diverse array of cultures (VanderStel, 2014). For the first time in history, many schools are on the verge of becoming majority-minority schools where the overall number of Latino, African American, and Asian students in public K-12 classrooms surpassed the number of non-Hispanic whites. The success of these students is inseparably linked to the well being of our nation (Maxwell, 2014). In addition to enrollment changes, educators must be mindful of a multitude of other challenges to students' education, including an increase in students living in poverty, an increase in English as a Second Language (ESL) learners, and an increase in students with vast differences in life experiences from those of their teachers, who remain overwhelmingly white. According to the National Center for Educational Statistics (2013), in the 2011-12 academic year, 82 percent of 3.4 million public school teachers were non-Hispanic whites, while only seven percent were non-Hispanic and eight percent were Hispanic. Previously in the 2003-04 academic year data, 83 percent of all public school teachers were non-Hispanic white- only a one percent difference within eight years (National Center for Education Statistics, 2013).

This shift is beginning to cause a disconnect between teacher and student cultures, extending into classroom instruction. Unfortunately, many of America's teachers lack

professional competence in the areas of diversity, experience in multicultural classrooms, and cross-cultural experiences. As a result, these teachers are not providing students with an education that expands their worldviews and allows them to become more informed of other cultures, nationalities, etc. (Cushner, McClelland, & Stafford, 2000). Furthermore, most teacher education programs do not provide pre-service teachers with significant intercultural experiences. Pre-service teachers are relatively inexperienced about global affairs, leaving a gap in classroom curriculum (Cushner, et al., 2000; Melnick & Zeichner, 1998). Regardless of their backgrounds, teachers will be called upon to teach individuals from very diverse backgrounds (Littleford & Nolan, 2013). This draws attention to a need to better educate our teachers in these areas which research shows they are lacking important experience and knowledge. In the world of agricultural education, experience and knowledge is especially important, as agriculture is not just a local phenomenon. Rather, agriculture spans across centuries and impacts every country in the world. Though the need for better cultural education of teachers and students applies to all areas of education, this work focuses specifically on the impact global exposure and the experiences of students have at the secondary level within the agriculture classroom.

### **Need for the Study**

A study by Lawrence, Rayfield, Moore, and Outley (2013) revealed that of the 7,487 FFA chapters in existence in 2010, the collective racial composition of the chapters did not accurately reflect the racial composition of the United States population. While the study did not consider the representation of individual school districts, the results showed a clear lack of diversity within these chapters. It is very concerning that the current demographics of FFA and agricultural education do not align with the demographics of public schools nationwide.

In another study by Lavergne, Larke, Elbert, and Jones (2011), researchers stated that “[t]he members of FFA and other agricultural education programs along with graduates in agricultural education teacher education programs across the nation do not reflect the ‘ethnic influx’,” (p. 140). Agriculture teachers are increasingly homogenous while the student population continues to become extremely diverse. As a result, those involved in agricultural education must begin a critical assessment of its recruitment, engagement, and retention practices for ethnically diverse youth or risk losing agricultural education programs to student attrition (Bowen, 2002).

With these challenges in mind, one of the items listed on the 2011-2015 national research agenda for agricultural education contains a scientific focus to “examine the role of diversity and multiple perspectives in meaningful learning across agricultural education contexts” (Doerfert, 2011, p. 9). To begin this process, it is vital to first gain an idea of the level of cultural proficiency, or effectiveness, of both agricultural students and agricultural educators. Once the intercultural effectiveness of students is known, teachers can then work on ways to increase their global exposure both in and out of the classroom.

### **Theoretical Framework**

This study was guided by the Mere Exposure Theory (Zajonc, 1968). According to Zajonc (1968), familiarity with and exposure to other culture impact the formation of one’s

thoughts and ideas about individuals who are culturally different. The theory is shaped by two main ideas: 1) repeated exposure to a stimulus increases ones' perceptual fluency (how easily one processes a stimulus) and 2) increased perceptual fluency increases positive affect, or the tendency for one to "like" something (Reber, Winkielman, & Schwarz, 1998).

Mere exposure theory is based on the phenomenon by which people tend to develop a preference for things merely because they are familiar with them and have been repeatedly exposed to them. This theory is also often called the familiarity principle. In early research, the effects have been demonstrated with paintings, faces, characters, and sounds (Zajonc, 1968). This principle was demonstrated by a study conducted by Carlson and Widaman (1988), in which students who were repeatedly exposed to another culture showed higher levels of concern and interest in the areas of international political concern, cross-cultural interest, and cultural cosmopolitanism.

When testing mere exposure, Zajonc found a strong connection between "familiarity" and "liking." This connection would later be known as the affective primacy hypothesis. This hypothesis states that affective reactions can be elicited with minimal stimulus input (Zajonc, 1980). In other words, the ability of someone to have an affective response to something (for example, liking something) requires very minimal stimuli. This was demonstrated in their experiment when subjects showed a positive bias or preference towards Chinese ideographs that they had been previously exposed to during the experiment. Additionally, the time that subjects spent making their decisions for liking an image, or not, decreased significantly on those images they had been exposed to previously (Kunst-Wilson & Zajonc, 1980).

While the theory of mere exposure is versatile and can be applied to multiple scenarios, it may hold the key to some of the world's cultural hostility issues. When something or someone is familiar, people unconsciously perceive that person or object as being more likeable and friendly. Is it possible much of the cultural dissonance that exists today is simply due to the lack of familiarity of one culture with another?

When taking the idea of mere exposure into consideration, one can see the power that this theory holds within the classroom context. The idea of mere exposure may be able to help expand the worldviews of our students by exposing them to individuals who are different from them. Regarding to this study, the mere exposure theory is the underlying basis for the idea that cultural exposure can happen within the walls of the classroom and extend far beyond the lesson curriculum. Mere exposure within the context of this study seeks lasting impacts on each of the students and teachers who are exposed to its effects.

### **Purpose**

The purpose of this descriptive correlational study is to examine the impact varying amounts of global exposure and previous travel experiences have on secondary agriculture students' Intercultural Effectiveness Survey (IES) performance. The guiding research questions for this quantitative study are as follows:

- 1) What international exposure have the participants encompassed?
- 2) What are the results of the student participants perceived Intercultural Effectiveness?

- 3) What is the relationship of students' Intercultural Effectiveness factors with one another?
- 4) What is the relationship of students' Intercultural Effectiveness by their own international exposure?

### Methods

To determine if there is any correlation between a student's score on the Intercultural Effectiveness Survey and their amount of global experiences and exposure, this correlational study consisted of conducting a survey on secondary students in agricultural education in Kentucky. Prior to the collection data, the Office of Research Integrity approved the use of human subjects. During data collection, participants completed a paper survey consisting of the IES questions in a Likert scale format, demographics, international exposure questions, and questions related to their agricultural education classrooms.

### Instrument

The instrument utilized during this study was adapted from the original Intercultural Effectiveness Scale (IES) created by the Kozai Group, Inc. (2015). The IES assessment survey evaluates competencies critical for effective interaction with people who are from cultures other than one's own based on their national culture, gender, generation, ethnic group, religious affiliation, etc. There are three main Intercultural Adaptability factors assessed by the survey: Continuous Learning, Interpersonal Engagement, and Hardiness. Each of these three are broken down into two additional dimensions for a total of six different constructs of assessment (Kozai Group, Inc., 2015). The following figure illustrates this breakdown of Intercultural Adaptability factors and their sub-sections. Table 1 further defines the six constructs (Mendenhall, Stevens, Bird, Oddou, & Osland, 2012).

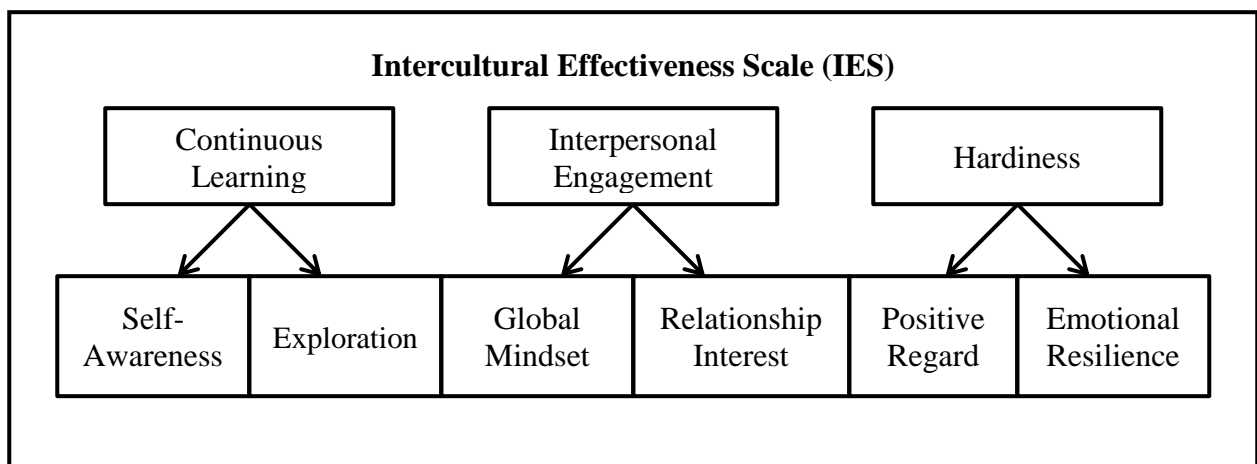

Figure 1: Intercultural Effectiveness Scale (Kozai Group, Inc., 2015)

Table 1

*Defining Constructs in the Intercultural Effectiveness Scale (Mendenhall, et al., 2012)*

<b>Construct</b>	<b>Definition</b>
Self-Awareness	The degree to which people are aware of their strengths and weaknesses in interpersonal skills, philosophies and values, how past experiences have helped shape them into who they are as a person, and the impact personal values and behavior have on relationships with others
Exploration	An openness and active pursuit of the understanding of ideas, values, norms, situations, and behaviors that are new and different
Global Mindset	The degree to which one is interested in and seeks to actively learn about other cultures and the people that live in them
Relationship Interest	The degree to which people have a desire and willingness to initiate and maintain relationships with people from other cultures
Positive Regard	The predisposition to view other cultures from a positive perspective
Emotional Resilience	A person's emotional strength and ability to cope with challenging cross-cultural situations

In terms of reliability measures for this instrument, the Kozai Group published reliability measures for the six intercultural effectiveness survey constructs and reliability scores are: self-awareness ( $a = 0.76$ ), exploration ( $a = 0.82$ ), global mindset ( $a = 0.84$ ), relationship interest ( $a = 0.80$ ), positive regard ( $a = 0.79$ ), and emotional resilience ( $a = 0.81$ ) (Mendenhall, et al., 2012). The instrument included all original Intercultural Effectiveness Survey questions in their entirety. In addition, the PI added additional demographic questions, which were tailored for high school students as the original survey was created for adults age 18 and up. The PI also added additional questions related to the student's agricultural education experiences. A panel of experts ( $n = 9$ ) reviewed the questionnaire, as amended, for face and content validity. The panel consisted of college professors with international experience as well as future agriculture teachers. The panel provided feedback that resulted in minimal amendments to the questionnaire, but not, of which, affected the overall intent of the questions and questionnaire.

### **Population and Sample**

To be considered for the study, each agricultural education program in Kentucky was considered for the overall population ( $N=126$ ). A variety of factors limited the overall population. Such limitations that led to the decrease in population were the presence of a teacher whose employment at the school was a minimum of four years. From the narrowed list, a random selection of 15 schools were selected and invited to participate. Due to scheduling conflicts or inability to gain administration permission for participation, 11 schools consented to participate. A total of 401 students participated in the study, however, due to missing answers or the inability to complete the survey, 14 surveys were omitted from the dataset.

From the selected agricultural education programs, 387 students participated in the study with the majority identifying themselves as White ( $f = 326, 84.24\%$ ) males ( $f = 226, 58.40\%$ ), and enrolled at sophomore status ( $f = 134, 34.63\%$ ). The largest number of students had taken

only one year of agriculture courses ( $f = 181, 46.77\%$ ). There was a total of 401 surveys given during this study. However, due to missing answers or inability to complete the survey, 14 surveys were omitted from the dataset.

## Data Analysis

Surveys were inputted manually into Google Forms and downloaded into a Microsoft Excel worksheet to allow for data analysis. Utilizing Google Forms allowed the researcher to see the breakdown of individual questions in a more user-friendly and readable format. Teacher surveys were removed from the student data to a separate spreadsheet for comparisons. Quantitative data from Likert scale and demographic questions were analyzed and correlations were derived using Pearson product-moment correlation and reported as an  $r$ . To provide a magnitude adjective to explain the correlations sought, Cohen's (1988) descriptors were utilized. The descriptors, as provided by Cohen, are: 0.0-0.1 "very small"; 0.1-0.3 "small"; 0.3-0.5 "medium"; 0.5-0.7 "large"; 0.7-0.9 "very large"; 0.9-1.0 "nearly perfect".

## Findings

Research question 1 sought to describe a variety of international exposures the students encompassed. When evaluating the languages spoken, many were English only ( $f = 350, 90.44\%$ ), followed by students who spoke two languages fluently ( $f = 33, 8.53\%$ ), students who spoke three languages fluently ( $f = 3, 0.78\%$ ), and students who could speak four languages, or more, fluently ( $f = 1, 0.26\%$ ). In terms of citizenship in another country, much of the participants were citizens of the United States only ( $f = 365, 94.32\%$ ). Most students surveyed had an agriculture teacher who had travelled outside of the U.S. ( $f = 271, 70.03\%$ ). Therefore, out of six teachers, five had travelled outside of the U.S. and one had not. Table 2 displays data related to the various international experiences and exposure of the students recorded using the survey instrument. Many students reported having no family members from another country ( $f = 318, 82.17\%$ ). Many of the students reported having no friends from another country ( $f = 260, 67.18\%$ ). When asked about the student's family members' military service overseas, the majority had a family member ( $f = 227, 58.66\%$ ) in the armed forces who had served, or are serving, overseas. Most students reported never living in another country ( $f = 374, 96.64\%$ ). The overwhelming majority of students reported that they had never completed a high school study abroad trip ( $f = 386, 99.74\%$ ). Unfortunately, only one student ( $f = 1, 0.26\%$ ) had taken advantage of a high school study abroad experience. Similarly, a majority of students reported that they had never travelled outside of the U.S. ( $f = 284, 73.39\%$ ). The final category in table 2 below describes the number of trips that the participants have taken outside of the U.S. The majority of students had never been outside of the U.S. ( $f = 280, 72.35\%$ ), followed by students who had taken one trip outside of the U.S. ( $f = 48, 12.40\%$ ), students who had taken two trips outside of the U.S. ( $f = 29, 7.49\%$ ), students who had taken three trips outside of the U.S. ( $f = 12, 3.10\%$ ), students who had taken six or more trips outside of the U.S. ( $f = 10, 2.58\%$ ), students who had taken four trips outside of the U.S. ( $f = 6, 1.55\%$ ), and students who had taken five trips outside of the U.S. ( $f = 2, 0.52\%$ ). Ten students (2.58%) had travelled six or more trips outside of the United States. ( $f = 10, 2.58\%$ ).

Table 2  
*Student Participant Demographics (n = 387)*

<b>Languages Spoken</b>	<i>f</i>	%
One	350	90.44
Two	33	8.53
Three	3	0.78
Four or more	1	0.26
<b>Citizenship in Other Country</b>	<i>f</i>	%
None	365	94.32
One	22	5.68
<b>Ag. Teacher has Travelled Outside the U.S.</b>	<i>f</i>	%
Yes	271	70.03
No	116	29.97
<b>Do You Have Family from Another Country?</b>	<i>f</i>	%
Yes	69	17.83
No	318	82.17
<b>Do You Have Friends from Another Country?</b>	<i>f</i>	%
Yes	127	32.82
No	260	67.18
<b>Do You Have Family in the Armed Forces Who Have Travelled/Served Overseas?</b>	<i>f</i>	%
Yes	227	58.66
No	160	41.34
<b>Have You Lived in Another Country?</b>	<i>f</i>	%
Yes	13	3.36
No	374	96.64
<b>Participation in a High School Study Abroad Program?</b>	<i>f</i>	%
Yes	1	0.26
No	386	99.74
<b>Have You Ever Travelled Outside of the U.S.?</b>	<i>f</i>	%
Yes	107	27.65
No	280	72.35
<b>Number of Trips Outside of the U.S.</b>	<i>f</i>	%
None	280	72.35
One	48	12.40
Two	29	7.49
Three	12	3.10
Four	6	1.55
Five	2	0.52
Six or More	10	2.58

Table 3 describes the Intercultural Effectiveness of the student participants ( $n = 387$ ). The students provided responses regarding the six areas of Intercultural effectiveness including: Self-

Awareness, Exploration, Global Mindset, Relationship Interest, Positive Regard, and Emotional Resilience. Once this data was collected, the mean, standard deviation, and range of the data were determined. When looking at each construct from the Intercultural Effectiveness Survey (IES) the following mean, standard deviation, and range were found for: Self-Awareness ( $m = 3.82$ ;  $SD = 0.08$ ); Exploration ( $m = 3.95$ ;  $SD = 0.46$ ); Global Mindset ( $m = 2.22$ ;  $SD = 0.71$ ); Relationship Interest ( $m = 3.05$ ;  $SD = 0.46$ ); Positive Regard ( $m = 3.47$ ;  $SD = 0.60$ ); and Emotional Resilience ( $m = 3.32$ ;  $SD = 0.51$ ).

Table 3

*Description of Student Intercultural Effectiveness (n = 387)*

<b>IES Construct</b>	<b>Mean (<i>m</i>)</b>	<b>Standard Deviation (<i>SD</i>)</b>	<b>Range (Low – High)</b>
Exploration	3.95	0.46	2.60 – 5.00
Self-Awareness	3.82	0.08	2.33 – 5.00
Positive Regard	3.47	0.60	1.44 – 5.00
Emotional Resilience	3.32	0.51	1.67 – 5.00
Relationship Interest	3.05	0.46	1.00 – 4.63
Global Mindset	2.22	0.71	1.00 – 4.57

Table 4 below provides information regarding the correlative relationship between these Intercultural Effectiveness Constructs mentioned above in Table 3. These constructs are as follows: Self-Awareness (SA), Exploration (EX), Global Mindset (GM), Relationship Interest (RI), Positive Regard (PR), and Emotional Resilience (ER). Self-Awareness has a large, positive relationship with Exploration ( $r = 0.575$ ), a very small positive relationship with Global Mindset ( $r = 0.087$ ), a small positive relationship with Relationship Interest ( $r = 0.179$ ), and a very small positive relationship with Positive Regard ( $r = 0.095$ ). Self-Awareness has a very small negative relationship ( $r = -0.044$ ) with Emotional Resilience. Exploration has a large positive relationship with Self-Awareness ( $r = 0.575$ ); a small positive relationship with Global Mindset ( $r = 0.178$ ); a small positive relationship with Relationship Interest ( $r = 0.163$ ) and Emotional Resilience ( $r = 0.109$ ); and a very small positive relationship with Positive Regard ( $r = 0.079$ ). Global Mindset has a very small positive relationship with Self Awareness ( $r = 0.087$ ) and Positive Regard ( $r = 0.058$ ); a small positive relationship with Exploration ( $r = 0.178$ ) and Emotional Resilience ( $r = 0.135$ ); and a medium positive relationship with Relationship Interest ( $r = 0.319$ ). Relationship Interest has a very small positive relationship with Self-Awareness ( $r = 0.179$ ), Exploration ( $r = 0.163$ ) and Emotional Resilience ( $r = 0.173$ ); a medium positive relationship with Global Mindset ( $r = 0.319$ ); and a small positive relationship with Positive Regard ( $r = 0.225$ ). Positive Regard has a very small positive relationship with Self-Awareness ( $r = 0.095$ ), Exploration ( $r = 0.075$ ) and Global Mindset ( $r = 0.058$ ); and a small positive relationship with Relationship Interest ( $r = 0.225$ ) and Emotional Resilience ( $r = 0.171$ ). Emotional Resilience has a small positive relationship with Exploration ( $r = 0.109$ ), Global Mindset ( $r = 0.134$ ), Relationship Interest ( $r = 0.173$ ) and Positive Regard ( $r = 0.171$ ). Emotional Resilience has a very small negative relationship with Self-Awareness ( $r = -0.044$ ).



Table 4

*Relationship of Intercultural Effectiveness Constructs*

	<b>SA</b>	<b>EX</b>	<b>GM</b>	<b>RI</b>	<b>PR</b>	<b>ER</b>
<b>SA</b>	-	0.575	0.087	0.179	0.095	-0.044
<b>EX</b>		-	0.178	0.163	0.079	0.109
<b>GM</b>			-	0.319	0.058	0.134
<b>RI</b>				-	0.225	0.173
<b>PR</b>					-	0.171
<b>ER</b>						-

Table 5 below shows the relationship among the various Intercultural Effectiveness Survey constructs (Self-Awareness, Exploration, Global Mindset, Relationship Interest, Positive Regard, and Emotional Resilience) to the additionally recorded student survey characteristics. These characteristics include: have/had citizenship in another country; high school agriculture teacher has travelled international; number of languages spoken; including having family from another country; having friends from another country; having family in the armed forces who have been overseas; having lived in another country; having participated in a school study abroad trip; travelled outside of the U.S.; and number of international experiences. In the following paragraph, correlation relationships among data will be described according to Miller's adjectives for description and inference, which were published in the Journal of Agricultural Education (1994).

Utilizing Cohen's (1988) descriptors for correlation, the findings revealed Self-Awareness had a very small positive relationship with teacher travel ( $r = 0.036$ ), student travel ( $r = 0.047$ ), and citizenship ( $r = 0.032$ ); however, Self-Awareness also has a very small negative relationship with having family from another country ( $r = -0.035$ ), having friends from another country ( $r = -0.006$ ), having family in the armed forces who have served overseas ( $r = -0.024$ ), the number of languages spoken ( $r = -0.041$ ), and having participated in a high school study abroad ( $r = -0.054$ ). Self-Awareness has a small positive relationship with having lived in another country ( $r = -0.106$ ). Exploration has a very small positive relationship with teacher travel ( $r = 0.024$ ), having family from another country ( $r = 0.028$ ), having family in the armed forces who have served overseas ( $r = 0.018$ ), having lived in another country ( $r = 0.056$ ), having participated in a high school study abroad ( $r = 0.016$ ), citizenship ( $r = 0.075$ ), and student travel ( $r = 0.068$ ). Exploration has a small positive relationship with having friends from another country ( $r = 0.147$ ). In addition, exploration has a very small negative relationship with the number of languages spoken ( $r = -0.029$ ). Global Mindset has a very small positive relationship with having family from another country ( $r = 0.064$ ), having friends from another country ( $r = 0.051$ ), having family in the armed forces who have served overseas ( $r = 0.055$ ), having lived in another country ( $r = 0.051$ ), having participated in a high school study abroad ( $r = 0.056$ ), and student travel ( $r = 0.019$ ). The number of languages spoken ( $r = 0.199$ ) and citizenship ( $r = 0.130$ ) both have a small positive relationship. However, Global Mindset has a very small negative relationship with teacher travel ( $r = -0.051$ ). Relationship Interest has a very small positive relationship with having family from another country ( $r = 0.010$ ), having family in the armed forces who have served overseas ( $r = 0.035$ ), and having participated in a high school study abroad ( $r = 0.036$ ), the number of languages spoken ( $r = 0.038$ ), and citizenship ( $r = 0.079$ ). However, Relationship Interest has a small negative relationship with teacher travel ( $r = -$

0.166), and a very small negative relationship with having friends from another country ( $r = -0.020$ ), having lived in another country ( $r = -0.062$ ), and student travel ( $r = -0.093$ ). Positive Regard has a very small positive relationship with having family from another country ( $r = 0.013$ ), having friends from another country ( $r = 0.046$ ), having family in the armed forces who have served overseas ( $r = 0.035$ ), having lived in another country ( $r = 0.067$ ), and having participated in a high school study abroad ( $r = 0.017$ ). However, Positive Regard has a very small negative relationship with teacher travel ( $r = -0.080$ ) and student travel ( $r = -0.028$ ). Emotional Resilience has a very small positive relationship with having family from another country ( $r = 0.043$ ), having friends from another country ( $r = 0.062$ ), having family in the armed forces who have served overseas ( $r = 0.019$ ), and having lived in another country ( $r = 0.35$ ). Emotional Resilience also has a very small negative relationship with teacher travel ( $r = -0.077$ ) and student travel ( $r = -0.022$ ).

Table 5  
*Relationship of Intercultural Effectiveness Constructs to Student Characteristics*

<b>IES Construct</b>	<b>Teacher Travel</b>	<b>Family from Other Country</b>	<b>Friends from Other Country</b>	<b>Family in Armed Forces</b>	<b>Lived in Another Country</b>	<b>High School Study Abroad</b>	<b>Student Travel</b>
<b>SA</b>	0.036	-0.035	-0.006	-0.024	-0.106	-0.054	0.047
<b>EX</b>	0.024	0.028	0.147	0.018	0.056	0.016	0.068
<b>GM</b>	-0.051	0.064	0.051	0.055	0.051	0.056	0.019
<b>RI</b>	-0.166	0.010	-0.020	0.035	-0.062	0.036	-0.093
<b>PR</b>	-0.080	0.013	0.046	0.035	0.067	0.017	-0.028
<b>ER</b>	-0.077	0.043	0.062	0.019	0.019	0.035	-0.022

### **Conclusion, Implications, and Limitations**

After examining this data, it can be concluded that the majority of student participants represented a homogenous population. Therefore, it is important to look at ways to increase student exposure to cultural diversity within the classroom to allow students to increase their level of cultural competence and intercultural effectiveness. Teachers should also continue to incorporate cultural activities and conversations within their curriculum and recruit diverse students to their programs.

Of the six constructs tested by the Intercultural Effectiveness Scale survey, students reported highest on Exploration. In a study conducted by Kealey (1996), having an interest in Exploration was as an important global competency. According to Kealey (1996), one's willingness to learn and their intrigue regarding different cultures usually lead to a desire to get to know a country, its people, and its traditions. Furthermore, studies conducted by those in the education field suggest that overseas teaching experiences for pre-service teachers are vital to expanding their intercultural effectiveness, develop an appreciation for the places they visit, and to critique their own culture in the process. This causes increased respect for diverse cultures and more tolerance and understanding of educational differences and barriers to education (Cushner & Mahon, 2002; Carlson & Widaman, 1988). Based on the findings from this study, as well as

that of research similar in style, it is recommended that secondary agricultural educators find ways to include more cross-cultural examples within their classrooms and curriculum in addition to continuing to increase their own level of intercultural effectiveness. As the Exploration data indicates, students are more interested in learning about other cultures or individuals who are culturally, and globally, different from them. One approach to the recommendation includes teachers incorporating examples of agricultural practices from other countries around the world and then comparing them to practices found in the United States. Teachers may also look to their local community for assistance in incorporating other cultures into their classrooms. One example of this could include a cultural lunch/dinner where students learn how to make a dish from another culture and must also present on the origins of this dish and agricultural practices used to grow the ingredients.

The second highest-scoring construct was Self Awareness. Jokinen (2005) stated that this competency was fundamental to one's ability to effectively work with people from other cultures. Similarly, Varner and Palmer (2005) argued that, "conscious cultural self-knowledge is a crucial variable in adapting to other cultures" (p. 1). Based on these findings, it is suggested that all teachers and students take an intercultural effectiveness survey to identify their strengths and weaknesses in intercultural communication and begin to work towards increasing their cultural competence in these six construct areas. High Self Awareness indicates that these secondary agriculture students would be more comfortable with who they are as individuals and also more adaptable to situations when they were exposed to other cultures. Students who perform higher in self-awareness appreciate classroom discussions about global policies and issues affecting agriculture. Because of the significance of this data in Self-Awareness teachers should encourage their students to discuss more controversial and analytical topics within the agricultural classroom. Topics such as animal rights/welfare, the ethics of cloning, and the perception of antibiotics in conventional farming methods may be examples of controversial issues to discuss.

Global Mindset was a low-scoring construct. In his research on international experiences in creating a teacher that is both culturally competent and internationally-minded, Cushner (2002) believed "humans, as social beings, learn best in situations when the complexity of social reality is encountered, examined, and understood" (p. 36). Furthermore, he discovered that the lived intercultural experience is the most beneficial type of experience in gaining a meaningful understanding of other cultures. In 2007, Cushner found that the value of lived experiences in expanding cross-cultural knowledge and developing a global perspective. This data implies that students who are familiar with other countries or cultures (through having family, friends, or other connections) will also be more likely to keep up with what is going on in these countries or cultures. Therefore, to improve students' Global Mindset, it is suggested that teachers require students to complete these types of assignments and participate in cultural interactions. The most beneficial and logical suggestion for increasing one's Global Mindset scores is to have these students (and teachers) interact with people who are culturally different from them. This includes utilizing residents from the community (i.e. local restaurant and store owners for specialty foods), utilizing an educational trip that is centered on agriculture (i.e. a tour of the major agricultural regions of France to learn about their major products and exports), or utilizing other means of technology to infuse cultural experiences into the classroom curriculum (i.e. video conference calls, videos, documentaries, or social media).

In addition to increasing our students' Global Mindset scores, it may also be beneficial to increase our teachers' Global Mindset scores. Therefore, it is suggested to pre-service teachers to participate in a study or student teaching abroad experience to enhance their teaching skills, intercultural effectiveness, and ability to adapt to various situations within the classroom. Along these same lines, it is suggested to pre-service teacher educators to offer such experiences, or work with the international student affairs office to create or seek out such experiences for students within the Agricultural Education major. Lastly, as a suggestion to Kentucky FFA State Staff members, it would be beneficial to offer an intercultural effectiveness professional development opportunity for current agricultural educators in the state. This opportunity could take place at summer conference and include a variety of topics ranging from teaching to diverse students, ways to increase diversity in your chapter, or how to incorporate culture into classroom curriculum.

In terms of the relationships between the students' Intercultural Effectiveness, as shown by Table 3, a positive relationship existed between Self-Awareness in relation to Exploration; while students who scored high in Global Mindset positively scored high in Relationship Interest. Remember from the construct descriptions earlier that Relationship Interest refers to the degree to which people have a desire and willingness to initiate and maintain relationships with people from other cultures. People high on this dimension work hard to develop relationships with others (Mendenhall et al., 2012) and Black, Morrison, and Gregersen (1999) describes it as the ability to emotionally connect with others. Based upon the data, it can be concluded that when students are more aware of themselves, they are also more likely to be interested in learning about other people. Students who have an elevated Global Mindset are also more likely to be interested in forming and keeping relationships with those who are culturally different from them. Therefore, the recommendation for all students to take the IES survey is strengthened. This will allow them to identify their cultural strengths and weaknesses and allow them to find ways in which they can improve their abilities in those lower-scoring constructs.

There are several limitations in this study. Though the researcher sought to collect accurate data, results may still be somewhat skewed. In utilizing the IES survey, which was created for an adult demographic, some examples given in the survey may have been dated or contained language that was confusing for some high school students. For example, many students did not know the definition of words such as "interpersonal" and were not familiar with "BBC news." These issues could have been avoided by piloting the survey with high school youth in addition to other adults. It is possible that students answered incorrectly or not at all due to confusing language or simply not understanding the statement/ question. A second limitation to this study may be the length of the survey itself. It is very possible that students may have started out answering the survey questions truthfully, but lost interest after the first page. It would be ideal to have an online survey or simply a shorter survey to keep students more engaged and attentive to the questions being asked.

Despite these limitations, the results of this study may help current agricultural educators to better understand the needs of their increasingly diverse student population, see where the average secondary student ranks in terms of intercultural awareness, and introduce the conversation of increasing intercultural effectiveness both in and out of the classroom.

Furthermore, in the ever-shifting cultural climate of America's schools, agricultural educators must take care to recruit and retain students from all races, ethnicities, genders, religions, and statuses. The very nature of education and the future of agriculture depend upon the diverse interactions that take place between those students and the lessons that are learned, not through the content of each lesson, but through those interactions with other students. Students should first learn to respect agriculture as one of the oldest traditions that has allowed us all to be part of an established society, and at the same time, learn to respect others for their diverse contributions, perspectives, and opinions no matter how similar or different they may be.

### References

- Black, J.S., Morrison, A. & Gregersen, H.B. (1999). *Global explorers: The next generation of leaders*. New York, NY: Routledge.
- Bowen, B. E. (2002). Advancing agricultural education within the context of an increasingly diverse society. *Journal of Agricultural Education*, 43(1), 1-11.  
doi:10.5032/jae.2002.01001
- Carlson, J. S., & Widaman, K. F. (1988). The effects of study abroad during college on attitudes toward other cultures. *International Journal of Intercultural Relations*, 1-17.
- Cushner, K. (2007). "The Role of Experience in the Making of Internationally-Minded Teachers." *Teacher Education Quarterly* 31(1), 27-38.
- Cushner, K., & Mahon, J. (2002). Overseas Student Teaching: Affecting Personal, Professional, and Global Competencies in an Age of Globalization. *Journal of Studies in International Education*, 6(1), 44-58.
- Cushner, K., McClelland, A., & Safford, P. (2000). *Human diversity in education: An integrative approach* (3<sup>rd</sup> ed). Boston, MA: McGraw-Hill.
- Doerfert, D. L. (Ed.) (2011). *National research agenda: American Association for Agricultural Education's research priority areas for 2011-2015*. Lubbock, TX: Texas Tech University, Department of Agricultural Education and Communications.
- Jokinen, T. (2005). "Global leadership competencies: a review and discussion." *Journal of European Industrial Training*, 29(3), 199-216.
- Kealey, D. J. (1996). *Handbook of intercultural training. The challenge of international personnel selection*. Thousand Oaks, CA: Sage Publications, 81-105.
- Kunst-Wilson, W. R., & Zajonc, R. B. (1980). Affective discrimination of stimuli that cannot be recognized. *Science*, 207, 557-558.
- Lavergne, D. D., Larke, Jr. A., Elbert, C. D., & Jones, W. A. (2011). The benefits and barriers toward diversity inclusion regarding agricultural science teachers in Texas secondary

- agricultural education programs. *The Journal of Agricultural Education*, 52(2), 140–150. doi:10.5032/jae.2011.02140
- Lawrence, S., Rayfield, J., Moore, L. L., & Outley, C. (2013). "An analysis of FFA chapter demographics as compared to schools and communities." *Journal of Agricultural Education* 54(1), 207-219. doi: 10.5032/jae.2013.01207
- Littleford, L., & Nolan, S. (2013, May 1). *Your sphere of influence: How to infuse cultural diversity into your psychology classes*. Retrieved Nov. 28, 2015, from <http://www.apa.org/ed/precollege/ptn/2013/05/cultural-diversity.aspx>
- Maxwell, L. A. (2014). "U.S. School Enrollment Hits Majority-Minority Milestone." *Education Week* 34(1), 1,12,14-15.
- Melnick, S. L., & Zeichner, K. M. (1998). Teacher education's responsibility to address diversity issues: Enhancing institutional capacity. *Theory Into Practice*, 37(2), 62-69.
- Mendenhall, M. E., Stevens, M. J., Bird, A., Oddou, G. R., & Osland, J. (2012). *Specification of the Content Domain of the Intercultural Effectiveness Scale*. The Kozai Monograph Series. Chesterfield, MO.
- Miller, L. E. (1994). "Correlations: Description or Inference?" *Journal of Agricultural Education* 35(1), 5-7. doi: 10.5032/jae.1994.01005
- National Center for Education Statistics. U.S. Department of Education. (2013). *Number and percentage distribution of teachers in public and private elementary and secondary schools, by selected teacher characteristics: Selected years, 1987-88 through 2011-12*.
- National FFA Organization. (2016). National FFA Organization, <https://www.ffa.org>
- Reber, R., Winkielman, P., Schwarz, N. (1998). "Effects of Perceptual Fluency on Affective Judgments." *Psychological Science* 9(1): 45-48.
- The Kozai Group, Inc. (2015). Intercultural Effectiveness Scale (IES). Retrieved December 19, 2016, from <http://www.kozai.com/intercultural-effectiveness-scale-ies/>.
- U.S. Census Bureau, U.S. Department of Commerce. (2012, December 12). *U.S. Census Bureau Projections Show a Slower Growing, Older, More Diverse Nation a Half Century from Now* [Press release]. *Newsroom Archive*. Retrieved July 7, 2016, from <https://www.census.gov/newsroom/releases/archives/population/cb12-243.html>
- VanderStel, A. (2014). The Impact of Demographics in Education. Honors Projects. G. V. S. University. 329, 1-18. <http://scholarworks.gvsu.edu/honorsprojects/329>
- Varner, I. I., & Palmer, T.M. (2005). Role of Cultural Self-Knowledge in Successful Expatriation. *Singapore Management Review*, 27(1), 1-25.

Zajonc, R. B. (1968). Attitudinal Effects of Mere Exposure. *Journal of Personality and Social Psychology*, 9(2), 1-27.

Zajonc, R. B. (1980). Feeling and thinking: Preferences need no inferences. *American Psychologist*, 35, 151-17

## Development and Validation of a Study Abroad Perceived Costs Scale

Brandon M. Raczkowski, Oklahoma State University  
Leslie D. Edgar, University of Arkansas  
J. Shane Robinson, Oklahoma State University  
Marshall A. Baker, Oklahoma State University

### Abstract

Study abroad experiences have high levels of variability regarding destination, duration, and depth. At their root, they exist to provide students an opportunity to explore various cultures, ideals, and lifestyles around the world. As a result, study abroad experiences remain a popular option for students in university settings. Those who desire to participate in high impact learning opportunities, such as study abroad, have varying levels of motivation, which has remained largely untapped. Using the expectancy-value theory as a context, the purpose of this study was to validate an instrument developed to assess college students' motivations to participate in a short-term study abroad course or experience. Exploratory and confirmatory factor analyses were conducted using R-type programming to confirm the factor structures. Findings revealed that the 16 items comprising the instrument developed by the researchers loaded onto four distinct factors structures consisting of emotional cost, outside effort cost, loss of valued alternatives cost, and task effort cost. Due to the rigorous psychometric properties employed in this study to validate the instrument, researchers can have confidence in including cost is a vital component to when assessing student motivations underpinned by the expectancy-value theory.

### Introduction

Assessing and understanding the value of study abroad opportunities for students in the United States has been a common theme in higher education since the 1970s (Hachtmann, 2012). Study abroad experiences for students have diversified over the years, starting as a general education model focused primarily on sending mostly female students to Western European countries for cultural and language training (Hachtmann, 2012). However, present day study abroad experiences focused largely on preparing students for a global marketplace of goods, services, and ideas. Yet, the *typical* study abroad experience is not easily defined (Hachtmann, 2012). Although difficult to define, an increase in student participation has occurred in colleges of agriculture (Estes, Hansen, & Edgar, 2016; Irani, Place, Lundy, & Friedel, 2004; Towsic, n.d.; Zhai & Scheer, 2004).

A study abroad experience is a common trend in higher education, where many institutions have experienced an increase in student participation during the past decade (North Association of Foreign Student Advisors [NAFSA], 2017). The increase in opportunities for students to be immersed in foreign languages, cultures, and lifestyles on a global level has been important (Clark, Flaherty, Wright, & McMillen, 2009). It is important because the benefits may include increased social proficiency, intercultural awareness, and openness to intercultural communication (Clark et al., 2009). Research suggests that there has been enhancement of students' worldviews, increases in their self-reliance and confidence, while providing students higher levels of openness and flexibility in regard to course taking (Özturgut, 2007). However,



“the decentralized nature of U.S. higher education allows for considerable variance in study abroad participation from institution to institution and from state to state” (NAFSA, 2017, p. 3). Short- or long-term study abroad programs may also influence students’ interest in interdisciplinary study and perceptions of globalization (Lewis & Niesenbaum, 2005).

Engaging in various international experiences provides students with many educational opportunities and instances to develop professionally and personally (Dooley, Dooley, & Carranza, 2008; Edgar, & Edgar, 2009; Estes, Hansen, & Edgar, 2016; Hall, 2007; Kitsantas & Meyers, 2001; Navarro & Edwards, 2008; Norris & Gillespie, 2009; Northfell & Edgar, 2014; Roberts & Edwards, 2016). The Institute for the International Education of Students (IES) surveyed alumni who studied abroad from 1950 through 1999 for a total of more than 3,400 respondents. The results showed participating in an international program was a defining occasion that continues to impact an individual’s life long after the program has ended. No matter where the individual studied abroad or the length of the program the impact still holds significance (Norris & Gillespie, 2009). The educational justifications for study abroad include increases in students’ levels of awareness of the interdependence of nations, the value of diversity, the development of global perspective, and the importance of international understanding (Kitsantas & Meyers, 2001). In addition to these educational justifications, it is also thought that study abroad experiences allow students to be more competitive in the job market after graduation and to develop language proficiency and lifelong friendships (Kitsantas & Meyers, 2001). Research also links the accumulation of culturally relevant knowledge gained from study abroad experiences to creative thinking processes (Lee, Therriault, & Linderholm, 2012).

Within the framework of a global knowledge-economy, universities provide and advertise study abroad opportunities that are thought to equip students with the skills, abilities, and mindsets “needed to deal with the realities of globalizing markets, greater job insecurity, and the likelihood of continual occupational mobility throughout their lives” (Barnick, 2010, p. 21). In 2010, the University of Arkansas set a goal for 25% of graduating seniors to complete an international experience by 2020 (University of Arkansas Annual Report, 2013); however, the current rate of graduating seniors in the Dale Bumpers College of Agricultural, Food and Life Science completing an international experience is about 5% annually. Although Dale Bumpers College of Agricultural, Food and Life Science students have shown positive perceptions to international program participation, the participation rates have not changed significantly in at least five years (Estes et al., 2016).

Research notes that international programs serve as an enhanced educational experience (Hachtmann, 2012) and prepare students for a globalized workforce (Andreasen, 2003). Students’ interests and motivations to participate in an international experience are mostly due to the effects it could have on their future, including (a) increasing awareness of diversity, (b) developing a global perspective, (c) improving job marketability, and (d) creating lifelong friendships (Estes et al., 2016; Kitsantas & Meyers, 2001; Norris & Gillespie, 2009). In addition, when selecting an international program, students engage in assessing the pros and cons of participating before committing (Estes et al., 2016). Understanding students’ motivational factors in relation to perceived barriers and benefits for studying abroad could better efforts intended to increase student participation in international programs (Danjean, Bunch, & Blackburn, 2016).

The major obstacle to an adequate relative costs model of study abroad is the lack of well-validated measures of the constructs, i.e., students' motivations and perceptions of barriers and benefits.

### **Theoretical Framework**

The expectancy-value theory (EVT) has been used for decades in an effort to understand motivational and social factors, including both long- and short-term achievement goals and behaviors (Eccles, 2013). This comprehensive model synthesizes multiple theoretical perspectives and captures key components of motivation in an effort to explain a wide range of achievement-related behaviors (Barron & Hulleman, 2014). The model focuses on understanding the subjective-task value, and is built on work associated with decision-making, achievement theory, and attribution theory (Crandall, 1969; Weiner, 1992). The EVT model is used to identify an individual's likely decision based on two beliefs: 1) an individual's expectation for success and 2) the importance or value the individual placed on the activity/task. Eccles (2013) noted: "We believe that the conscious and non-conscious choices people make about how to spend time and effort lead, over time, to marked differences between groups and individuals in lifelong achievement-related patterns" (p. 106). Researchers have noted that the critical issue is the relative personal value an individual places on the choice options they face (Barron & Hulleman, 2014; Crandall, 1969; Eccles, 2013; Weiner, 1992).

Recent empirical research suggests cost is a separate factor from expectancy and value (Barron & Hulleman, 2014; Flake, Barron, Hulleman, McCoach, & Welsh, 2015; Kosovich, Hulleman, Barron, & Getty, 2015) that can influence an individual's overall motivation to engage in a task. Other have concluded perceived costs are negatively related to achievement-related choices and performance (Conley, 2012; Grays, 2013; Kosovich et al., 2015; Perez, Cromley, & Kaplan, 2014). According to Hulleman, Barron, Kosovich, & Lazowski (2016), this allows us to consider perceived cost as a distinct source of motivation. To this point, consider the updated expectancy-value-cost model of achievement motivation illustrated in Figure 1.

Study abroad programs are viewed as a mechanism for cultivating global awareness and competency in students (Norris & Gillespie, 2009; Salisbury, Umbach, Paulsen, & Pascarella, 2008). From a student perspective, perceived benefits may include (a) exposure to a different culture, (b) listing participation on a resume or CV, and (c) the opportunity to study subjects not available locally or within their degree programs (Anderson, Hubbard, & Lawton, 2015; Danjean et al., 2016; Doyle, Gendall, & Meyer, 2010; Estes et al., 2016; Lee et al., 2012). The most commonly perceived barrier is focused on financial concerns, as well as lack of knowledge about programming, and confidence navigating a foreign landscape (Anderson et al., 2015; Danjean et al., 2016; Doyle et al., 2010; Estes et al., 2016; Lee et al., 2012). As based on the expectancy-value-cost-model, this research study was an attempt to determine student motivational factors as outlined in study abroad barriers at a land-grant university in the mid-south region of the United States.

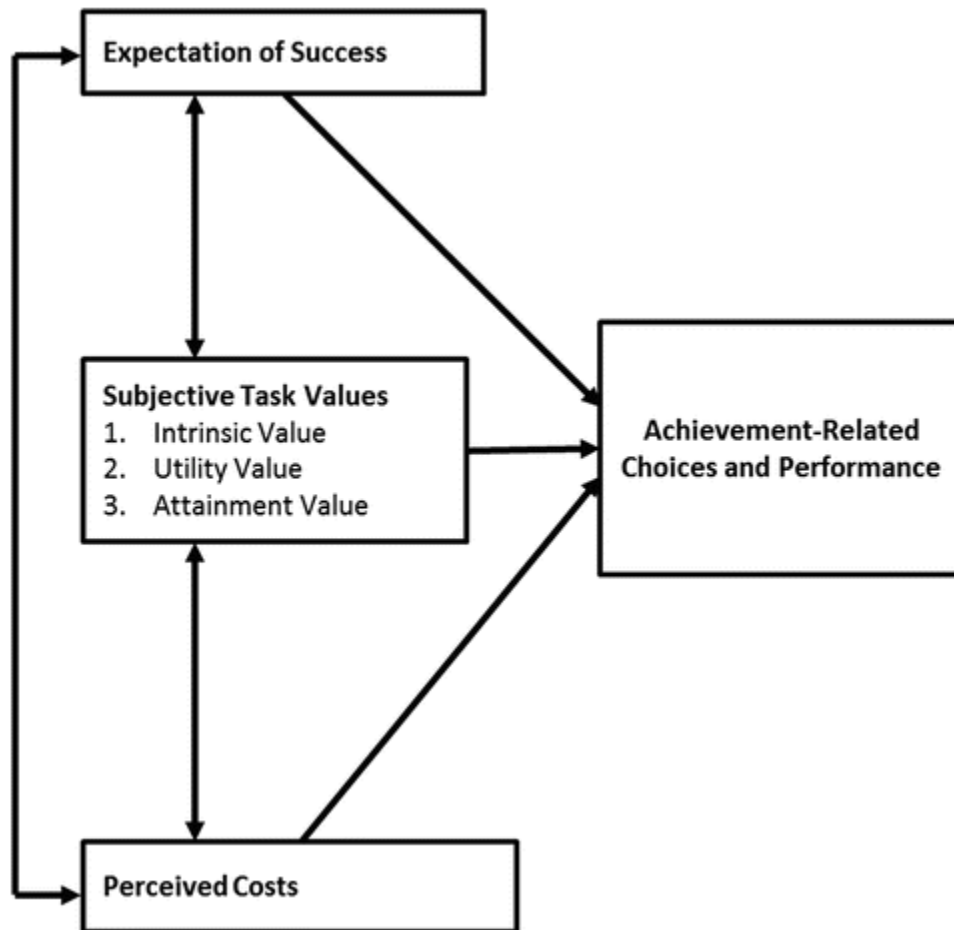

Figure 1. Updated Expectancy-Value-Cost Model of Achievement Motivation (adapted from Eccles et al., 1983; Barron & Hulleman, 2014).

### Purpose and Objectives

This study sought to validate an instrument developed to assess college students’ motivations to participate in a short-term study abroad course or experience. We used a sequential approach with a dataset split into two subsets. The objectives of this study were threefold: 1) What were the relative costs factors and construct validity of items used as measures regarding undergraduate participation in a short-term, study abroad course? 2) Were the factors of undergraduate perceptions of perceived costs to study abroad reliable? 3) Using perceived costs factors, were undergraduates motivated to participate in short-term, study abroad courses? This study aligns with Research Priority 2: New Technologies, Practices, and Products Adoption Decisions (Roberts, Harder, & Brashears, 2016).

## Method and Procedures

### Participants

Undergraduate students (freshman to senior) at a large, mid-southern region, land-grant university were recruited during the Fall 2017 semester to complete the perceived costs measure for short-term study abroad courses or experiences. The results would inform a larger study investigating overall motivations to participate in international experiences prior to graduating. The survey population consisted of a stratified random sample by academic department (Trochim, 2001) of large-enrollment, required courses by major, and all freshman orientation Fall 2017 undergraduate courses in the Dale Bumpers College of Agricultural, Food and Life Science. At the time of this abstract, 17 courses had been surveyed and data entered with 23 additional class visits scheduled or survey data needed entering. Instruments were provided in paper form to students in classes. Undergraduate students ( $n = 1,000$ ) spanning several academic disciplines and colleges participated due to the nature of student enrollment in the college. A large proportion of respondents self-identified as sophomores (39%) and juniors (33%), while freshman (20%) and seniors (8%) were less prevalent. A majority of participants (93%) had not previously participated in a university international program. However, 70% identified short-term faculty-led programs as the type of international experience they are most interested.

### Measure

The first version of the instrument was developed to assess college students' perceived costs in short-term, study abroad courses or experiences (Blind authors, 2017). The instrument was a self-report measure consisting of 16 items. Items were adapted from the expectancy-value-cost model instrument (Flake et al., 2015). The first version of the instrument was pilot-tested with a convenience sample of agricultural students ( $n = 219$ ) at another land-grant institution (blind authors 2017). Data was collected online using Qualtrics Survey Software and imported into IBM SPSS Statistics 21 for analysis. Exploratory factor analysis (EFA) with a Promax rotation was used to determine the underlying factor structure of the items; four factors emerged: 1) outside effort cost; 2) loss of valued alternatives cost; 3) emotional cost; and 4) task effort cost.

Following the analysis of data derived from the pilot test, it was determined that the expectancy-value-cost model (Flake et al., 2015) was an appropriate theoretical framework for the instrument's intent. Items were further revised and added to align with the factors of the expectancy-value-cost model. We presented these items to a panel of experts to collect validity evidence. Respondents completed a paper-based version of the revised instrument – with response categories ranging from 1 (*Completely disagree*) to 5 (*Completely agree*).

### Data Analysis

Descriptive statistics were computed using IBM SPSS Statistics 21. System-missing values were excluded from the analysis automatically by SPSS 21. Post-hoc Cronbach's alpha scores were used to determine the internal reliability of the instrument. Pearson's correlation coefficients were used to examine the relationships among the variables of interest. For factor analysis, the data were divided into one of two subsets using the random sample of cases function in SPSS 21,

one set for exploratory factor analysis (EFA) and one set for confirmatory factor analysis (CFA). The psychometric investigation began with an EFA to determine the underlying factor structure of the dataset. We used multiple methods to establish the number of factors to retain, i.e., eigenvalue > 1, scree test, and parallel analysis (Henson & Roberts, 2006). We extracted the underlying factors using principal axis factoring with a Promax rotation in SPSS 21, and then used the results from the EFA to conduct confirmatory factor analyses to validate the hypothesized factor structure within the **R** statistical environment (Beaujean, 2013).

**R** is a very powerful statistical package where all analysis can be completed in the same program. This is especially useful for structural equation modeling (Beaujean, 2013). Another reason for using **R** is the “vast majority of syntax and packages are transportable from one system to another. This can aid in both research collaboration and making one’s research replicable, as colleagues can reproduce results by copying and pasting the syntax” (Beaujean, 2013, p. 1).

The syntax for the four factor (CFA) model is given below.

```
1 #Read in data set:
2 data = read.csv(file = "filename.csv", na.strings=".")
3 head(data)
4 dim(data)
5 cov(data[,1:12])
6 cor(data[,1:12])
7 model03.syntax = "
8 #factor specification statement (only statement needed)
9 EC =~ Q3S + Q3T + Q3R
10 OEC =~ Q3G + Q3K + Q3E
11 LOVA =~ Q3F + Q3D + Q3I
12 TEC =~ Q3L + Q3P + Q3J
13"
14 #model estimation
15 model03.fit <- sem(model03.syntax, data=data, mimic="Mplus", estimator = "MLR")
16 #display model output
17 summary(model03.fit, fit.measures = TRUE, standardized = TRUE)
18 attributes(model03.fit)
19 #display normalized residual covariances
20 residuals(model03.fit, type="normalized")
21 #reorder normalized residuals from largest in absolute value to smallest in absolute
    value
22 residual_matrix = residuals(model03.fit, type="normalized")$cov
23 norm_resid = NULL
24 #plot path diagram with unstandardized coefficients
25 install.packages("semPlot")
26 install.packages("pbkrtest")
27 library("semPlot")
28 semPlotModel(model03.fit)
```

```

29 semPaths(model03.fit,intercepts = TRUE, residuals = TRUE, style="mx",
    layout="tree", rotation=1, optimizeLatRes=TRUE, whatLabels = "par")
30 #Checking residual covariances repetitions
31 summary(abs(residual_matrix)>2)
32 #get model-estimated mean and covariance matrix
33 fitted(model03.fit)
34 #getting model R^2
35 inspect(model03.fit, what="r2")
36 #plot path diagram with standardized coefficients
37 semPaths(model03.fit,intercepts = TRUE, residuals = TRUE, style="mx",
    layout="tree", rotation=1, optimizeLatRes=TRUE, whatLabels = "std")

```

## Results

Three analyses were utilized to address each of the research questions. Results are presented by research question.

### Research Question 1: Exploratory Factor Analysis

To address research question one, the first dataset ( $n = 473$ ) was used to conduct an exploratory factor analysis (principal axis factoring with a Promax rotation) of the revised instrument (19-items) to determine if a set of latent factors represented undergraduate students' perceived costs regarding participation in short-term, study abroad courses or experiences. Factors with three or more loadings greater than .50 were considered to be strong and stable (Costello & Osbourne, 2005). The suitability of the data for factor analysis was determined using standard conventions, i.e., the Kaiser-Meyer-Okin measure of sampling adequacy ( $KMO = .94$ ) and Bartlett's test of sphericity ( $p = .000$ ). A four factor solution was selected because it explained the most variance (84%) with the fewest factors prior to rotations and met the selection criteria. *Emotional cost* consisted of three items, which represented if students perceived short-term study abroad courses to be emotionally draining, worrisome, and anxiety ridden (see Table 1). *Outside effort cost* consisted of three items, which represented college student's beliefs about time and effort put forth for tasks other than short-term study abroad courses or experiences. *Loss of valued alternatives cost* consisted of three items, which represented their regarding short-term study abroad courses or experiences preventing them from doing other things and missing out on valued alternatives. *Task effort cost* consisted of three items, which represented perceptions about the amount of time and effort a short-term study abroad program would require (see Table 1).

Table 1

*Communalities and Factor Loadings from Exploratory Factor Analysis of the Study Abroad Perceived Costs Scale, Subset 1 (n = 473)*

Items	Factor Loadings	Communalities
<b>Emotional Cost</b>		
EC_1: Will be emotionally draining	0.91	0.84
EC_2: I will worry too much	0.87	0.78
EC_3: Makes me feel too anxious	0.80	0.67
<b>Outside Effort Cost</b>		
OEC_1: Because of all the other things I do, I will not have time	0.92	0.74
OEC_2: Because of all the other demands on my time, I will not have enough time	0.83	0.81
OEC_3: I will have so many responsibilities that I am unable to put forth the effort	0.77	0.71
<b>Loss of Valued Alternatives Cost</b>		
LOVA_1: Will cause me to miss too many other things I care about	0.84	0.83
LOVA_2: Will prevent me from spending time doing other things I like	0.80	0.67
LOVA_3: I will not spend as much time doing the other things that I would like	0.73	0.76
<b>Task Effort Cost</b>		
TEC_1: Will be too much work	0.69	0.75
TEC_2: I will have to put forth too much energy	0.65	0.73
TEC_3: Will be too exhausting	0.60	0.68

## Research Question 2: Confirmatory Factor Analysis

Research question two utilized the second subset ( $n = 487$ ) to conduct a confirmatory factor analysis (CFA) validating the hypothesized factor structure based on the EFA results. Goodness of fit was evaluated using the root mean square error of approximation (RMSEA),  $p$  value to test fit, standardized root mean square residual (SRMR), and comparative fit index (CFI). All model-fit criteria were sufficient: RMSA  $< .08$ ; 90% CI; SRMR  $< .05$ ; CFI  $> .90$  (Kline, 2011). The chi-square test is reported, but its results are de-emphasized due to over-sensitivity to sample size (see Table 2). Together, these fit indices provided a holistic and conservative approach to determining model fitness (Jackson, Gillaspay, & Purc-Stephenson, 2009). A path analysis diagram of the four factor model is provided to illustrate the relationships between the study's variables (see Figure 2).

Table 2

*CFA Fit Indices for the Four Factor Model of Study Abroad Perceived Costs Scale, Subset 2 (n = 476)*

Model	$\chi^2$	<i>df</i>	<i>CFI</i>	<i>RMSEA</i>	<i>RMSEA CI</i> <sub>90</sub>	<i>SRMR</i>
Four Factor	66.892*	48	.993	.029	.009 – .054	.019

*Note.* RMSEA = Root Mean Square Error of Approximation; CFI = Comparative Fit Index.

\* $p = .037$ .



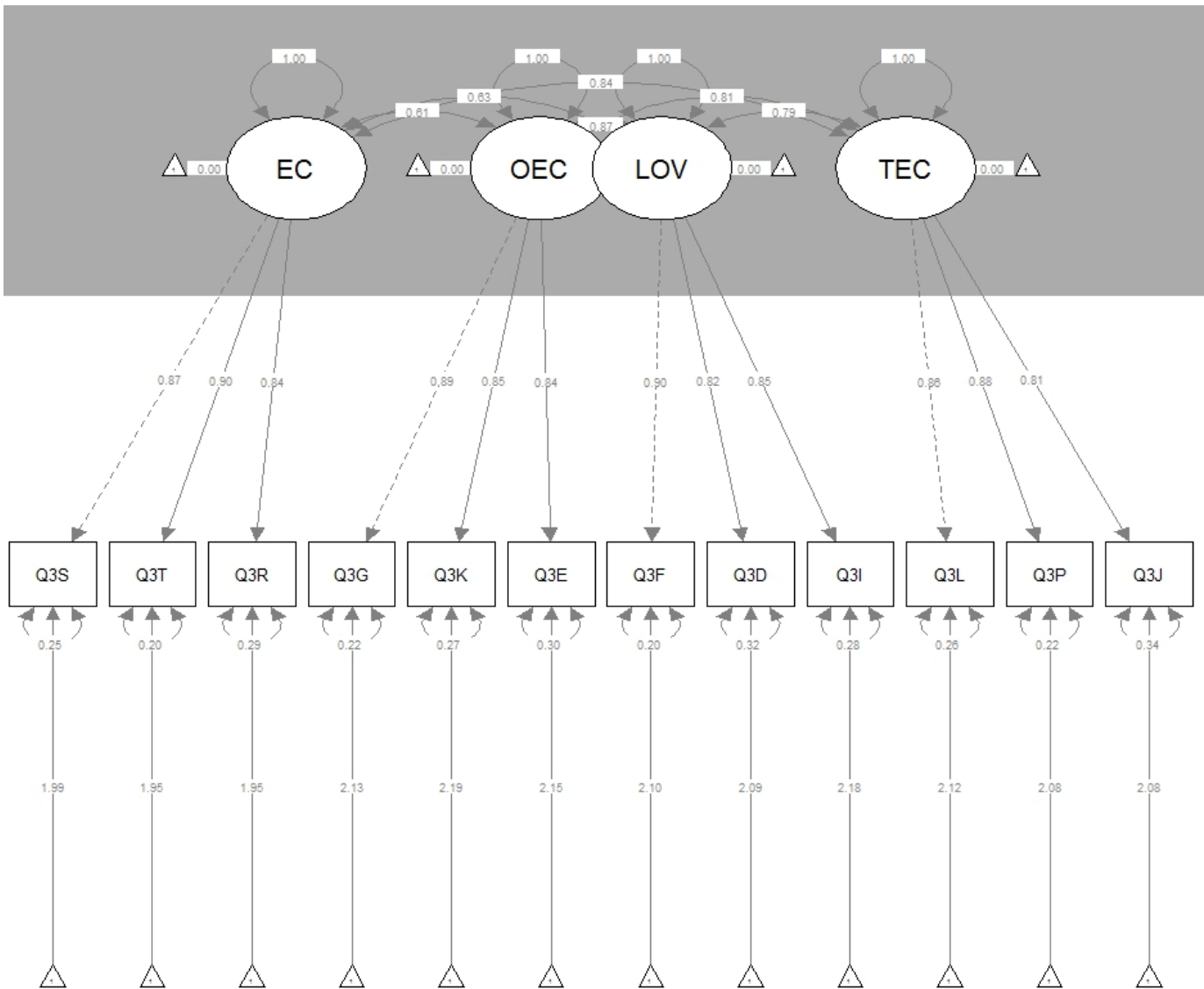

*Figure 2.* Path Analysis for the Four Factor Model of the Study Abroad Perceived Costs Scale. EC = Emotional Cost; OEC = Outside Effort Cost; LOV = Loss of Valued Alternatives Cost; TEC = Task Effort Cost.

Reliability coefficients using Cronbach's alpha scores were used to determine if the four factors were reliable among data subset 2 ( $n = 476$ ). Each of the four factors had reliability coefficients greater than .89, which were considered acceptable. Reliabilities of the individual factors are presented in Table 3.

Table 3

*Descriptive Statistics and Correlations Among Study Abroad Perceived Costs Scale Composite Scores, Subset 2 (n = 476)*

Variables	Emotional cost	Outside effort cost	Loss of valued alternatives	Task effort cost
Outside effort cost	0.61**			
Loss of valued alternatives	0.63**	0.87**		
Task effort cost	0.84**	0.81**	0.79**	
Cronbach's alpha	0.90	0.89	0.89	0.89
<i>Mean</i>	2.23	2.71	2.54	2.26
<i>Standard Deviation</i>	1.04	1.15	1.09	0.98

\*\* $p < .01$ .

### Research Question 3: Descriptive Statistics Related to Motivations to Study Abroad

Descriptive statistics were utilized to address research question three. Means and standard deviations for each of the four perceived costs are noted in Table 3. *Outside effort cost* ( $M = 2.71$ ;  $SD = 1.15$ ) and *loss of valued alternatives cost* ( $M = 2.54$   $SD = 1.09$ ) were the largest perceived costs regarding short-term study abroad courses or experiences, which meant students were less likely to participate because of the amount of time and effort they will have to put forth for other tasks and what they will have to give up as a result of participating.

### Conclusions, Discussion, Implications, and Recommendations

Here, we present a very concise report of the results. The sequential, two-phased approach uncovered the four dimensions of perceived costs (emotional cost, outside effort cost, loss of valued alternatives cost, and task effort cost) and provided evidence for the psychometric properties of the 12-item instrument. The four factor model emerged from the EFA analyses as suggested by Flake et al. (2015). The fit indices from the CFA suggested the four factor model provides an acceptable fit.

Although this research does provide validity evidence for a four factor model of the Study Abroad Perceived Costs Scale (SAPCS), it is not without limitations. The students in our study were from a mid-south region, land-grant university. As a result, the findings may not be generalizable to all students at land-grant universities. Additional research on the factor structure

of the SAPCS with students from other land-grant universities is needed. One potential research question related to location is whether students' perceived costs vary by geographical region (Bunch, Lamm, Israel, & Edwards, 2013). In addition, the results are limited to construct validity of the scale. Our results support the validity of the four factor model, but not information about the degree to which perceived costs factors predict achievement-related choices and performance (Barron & Hulleman, 2014; Eccles et al., 1983). At the same time, research by (Blind authors, 2017) revealed that *outside effort cost* was predictive of students' overall motivation and intent to enroll in a short-term study abroad course or experience before graduating. However, the results of their pilot study were limited by poor response rate and an un-validated scale. In this study, outside effort cost and *loss of valued alternatives costs* appear to be the most likely prohibitor for participation in short-term study abroad courses or experiences. However, the ability of these factors to predict achievement-related choices and performance remains an opportunity warranting further research.

Despite the limitations, this is the first factor analytic study of the SAPCS among college students at a land-grant university. Because this four factor model is a very different (truncated) version from previous iterations of the expectancy-value-cost model instrument (Flake et al., 2015), an empirical investigation such as this provides a unique contribution to the literature regarding the assessment of motivational barriers and benefits by college students at a land-grant university. This research should provide guidance to faculty and administrators in their roles as leaders and administrators involved in the process of internationalizing land-grant campuses and curriculum.

Research has been clear in establishing the benefits of study abroad experiences (Dooley, Dooley, & Carranza, 2008; Edgar, & Edgar, 2009; Estes, Hansen, & Edgar, 2016; Hall, 2007; Kitsantas & Meyers, 2001; Navarro & Edwards, 2008; Norris & Gillespie, 2009; Northfell & Edgar, 2014; Roberts & Edwards, 2016). Studies have also identified that students are motivated to study abroad when considering intrinsic, attainment, and utility subjective task values. Why is it that student participation rates remain stagnant (Estes et al., 2016)? Perhaps we have spent too much time asking students of their *value* of study abroad experiences rather than the *cost* of participating. The 12-item study of interest in this study should be used to further understand the cost dimension of students' decision to study abroad. A deeper, and valid, understanding of how students perceive cost could be informative in developing strategies to engage more students in this valuable learning experience. For example, this study found that *outside effort cost* and *loss of valued alternatives cost* are the largest factors when students consider traveling abroad. How could those factors be mitigated? Are those student perceptions of cost accurate? What is the impact of perceived cost when various interventions are utilized? These questions can be more fully examined with the development and confirmation of the cost scale presented and validated in this study.

## References

- Anderson, P. H., Hubbard, A., & Lawton, L. (2015). Student motivation to study abroad and their intercultural development. *The Interdisciplinary Journal of Study Abroad*, 26, 39–52.
- Andreasen, R. J. (2003). Barriers to international involvement. *Journal of International Agricultural and Extension Education*, 10(3), 65–69.
- Barnick, H. (2010). Managing time and making space: Canadian students' motivations for study in Australia. *Anthropology in Action*, 17(1), 19–29. doi:10.3167/aia2010.170103
- Barron, K. E., & Hulleman, C. (2014). Expectancy-value-cost model of motivation. In J. S. Eccles & K. Salmelo-Aro (Eds.), *International Encyclopedia of Social & Behavioral Sciences, 2nd edition: Motivational Psychology*. Elsevier.
- Beaujean, A. (2013). Factor analysis using R. *Practical Assessment, Research & Evaluation*, 18. Retrieved from [www.pareonline.net/pdf/v18n4pdf](http://www.pareonline.net/pdf/v18n4pdf)
- Blind authors, (2017). Title. *Proceedings of the AAAE Western Region AAAE Research Conference*. Fort Collins, CO. Retrieved at <http://aaaeonline.org/2017-Western-Region>
- Bunch, J. C., Lamm, A. J., Israel, G. D., & Edwards, M. C. (2013). Assessing the motivators and barriers influencing undergraduate students' choices to participate in international experiences. *Journal of Agricultural Education*, 54(2), 217-231. doi:10.5032/jae.2013.02217
- Clarke, III, I., Flaherty, T., Wright, N., & McMillen, R. (2009). Student intercultural proficiency from study abroad programs. *Journal of Marketing Education*, 31(2), 173–181.
- Conley, D. M. (2012). Cultural dimensions of human capital development. In *Global networks, global perspectives, global talent: Discussions on the development of human capital in agribusiness*. College Station, TX: International Food and Agribusiness Management Review. Retrieved from <http://www.ifama.org/resources/Documents/v15ia/v15ia.pdf#page=87>
- Costello, A. B., & Osbourne, J. W. (2005). Best practices in exploratory factor analysis: Four recommendations for getting the most from your analysis. *Practical Assessment, Research & Evaluation*, 10(7), 1–9. Retrieved from <http://www.pareonline.net/pdf/v10n7.pdf>
- Crandall, V. C. (1969). Sex differences in expectancy of intellectual and academic reinforcement. In C. P. Smith (Ed.), *Achievement Related Behaviors in Children* (pp. 11–45). New York, NY: Russell Sate Foundation.

- Danjean, S., Bunch, J. C., & Blackburn, J. (2016). Examining the motivations and barriers influencing the decisions of Louisiana State University College of Agriculture freshmen to participate in international experiences. *Journal of International Agricultural and Extension Education*, 22(1), 49–62. doi:10.5191/jiaee.2015.22104
- Dooley, K. E., Dooley, L. M., & Carranza, G. (2008). Beliefs, barriers, and benefits of a faculty abroad experience in Mexico. *Journal of International Agricultural and Extension Education*, 15(3), 29–38.
- Doyle S., Gendall, P., & Meyer, L. H. (2010). An investigation of factors associated with student participation in study abroad. *Journal of Studies in International Education*, 14(5), 471–490. doi:10.1177/1028315309336032
- Eccles, J. (2013). Subjective task value and the Eccles et al. model of achievement-related choice. In (Ed.), *The handbook of competence and motivation*. New York, NY: The Guilford Press.
- Eccles, J. S., Adler, T. F., Futterman, R. Goff, S. B., Kaczala, C. M., & Meece, J. (1983). Expectancies, values and academic behaviors. In J. T. Spence (ed), *Achievement and achievement motives* (pp. 75 – 146). San Francisco, CA: W. H. Freeman.
- Edgar, D. W., & Edgar, L. D. (2009). Students’ perceptions of Mexican agricultural practices occurring in Chihuahua State. *Journal of Southern Agricultural Education Research*, 59. Retrieved from <http://www.jsaer.org/pdf/Vol59/2009-59-004.pdf>
- Estes, S., Hansen, M. J., & Edgar, L. D. (2016). University student and faculty needs, barriers, and expectations of international efforts and opportunities: A closer look at one land-grant university’s college of agriculture. *Journal of International Agricultural & Extension Education*, 23(1). doi:10.5191/jiaee.2016.23103
- Flake, J. K., Barron, K. E., Hulleman, C., McCoach, B. D., & Welsh, M. E. (2015). Measuring cost: The forgotten component of expectancy-value theory. *Contemporary Educational Psychology*, 41(2015), 232–244. Retrieved from <https://doi.org/10.1016/j.cedpsych.2015.03.002>
- Grays, M. (2013). Measuring motivation for coursework across the academic career: A longitudinal invariance. *Dissertations*. 76. <http://commons.lib.jmy.edu/diss201019/76>
- Hachtmann, F. (2012). The effect of advertising-focused, short-term study abroad programs on students’ worldviews. *Faculty Publications, College of Journalism & Mass Communications*. Paper 68. Retrieved from <http://digitalcommons.unl.edu/journalismfacpub/68>
- Hall, D. E. (2007, October). Why professors should teach abroad. *The Chronicle of Higher Education* (The Chronicle Review Section), 54(6), B20.

- Henson, R. K., & Roberts, J. K. (2006). Use of exploratory factor analysis in published research: Common errors and some comment on improved practice. *Educational and Psychological Measurement, 66*(3), 393–416. doi:10.1177/0013164405282485
- Hulleman, C. S., Barron, K. E., Kosovich, J. J., & Lazowski, R. A. (2016). Student motivation: Current theories, constructs, and interventions within an expectancy-value framework. In A. A. Lipnevich, F. Preckel, & R. D. Roberts, *Psychosocial skills and school systems in the 21st century: Theory, research, and practice*. Switzerland: Springer International Publishing.
- Irani, T., Place, N. T., Lundy, L., & Friedel C. (2004). Experience, perceptions, and likelihood of participation in international opportunities among college of agricultural and life science students. Proceedings from the *20th Annual Association for International Agricultural and Extension Education Conference*, 273–283.
- Jackson, D. L., Gillaspay, Jr., J. A., & Purc-Stephenson, R. (2009). Reporting practices in confirmatory factor analysis: An overview of some recommendations. *Psychological Methods, 14*(1), 6–23.
- Kitsantas, A., & Meyers, J. (2001). Studying abroad: Does it enhance college student cross-cultural awareness? Paper session presented at the combined *Annual Meeting of the San Diego State University and the U.S. Department of Education Centers for International Business Education and Research*, San Diego, CA.
- Kline, R. B. (2011). *Principles and practice of structural equation modeling* (3rd ed). New York, NY: Guilford Press.
- Kosovich, J. J., Hulleman, C. S., Barron, K. E., & Getty, S. (2015). A practical measure of student motivation: Establishing validity evidence for the expectancy-value-cost scale in middle school. *Journal of Early Adolescence, 35*(5-6), 790–816. doi:10.1177/0272431614556890
- Lee, C. S., Therriault, D. J., & Linderholm, T. (2012). On the cognitive benefits of cultural experience: Exploring the relationship between studying abroad and creative thinking. *Applied Cognitive Psychology, Applied Cognitive Psychology, 26*(5), 768–778. doi:10.1002/acp.2857.
- Lewis, T. L., & Niesenbaum, R. A. (2005). Extending the stay: Using community-based research and service learning to enhance short-term study abroad. *Journal of Studies in International Education, 9*(3), 251–265. doi:10.1177/1028315305277682
- Navarro, M., & Edwards, M. C. (2008). Priorities for undergraduate education and the inclusion of internationalized curriculum in colleges of agriculture: Interpreting and negotiating the “comparison dilemma.” *Journal of Agricultural Education, 49*(4), 72-82. doi:10.5032/jae.2008.04072

- Norris, E. M., & Gillespie, J. (2009). How study abroad shapes global careers: Evidence from the United States. *Journal of Studies in International Education*, 13(3), 382–397. doi:10.1177/1028315308319740
- North Association of Foreign Student Advisors [NAFSA]. (2017). Trends in U.S. study abroad. Retrieved from [http://www.nafsa.org/Policy\\_and\\_Advocacy/Policy\\_Resources/Policy\\_Trends\\_and\\_Data/Trends\\_in\\_U\\_S\\_Study\\_Abroad](http://www.nafsa.org/Policy_and_Advocacy/Policy_Resources/Policy_Trends_and_Data/Trends_in_U_S_Study_Abroad)
- Norris, E. M., & Gillespie, J. (2009). How study abroad shapes global careers: Evidence from the United States. *Journal of Studies in International Education*, 13(3), 382–397. doi:10.1177/1028315308319740
- Northfell, A., & Edgar, L. D. (2014). Using reflective journals to compare an international faculty-led study tour and student internship experience. *Journal of Applied Communications*, 98(4), 28–41.
- Özturgut, O. (2007, Fall). Study/teach abroad programs for higher education faculty. *Essays in Education*, 22, 42–49.
- Perez, T., Cromley, J. G., & Kaplan, A. (2014). The role of identify development, values, and costs in college STEM retention. *Journal of Educational Psychology*, 106(1), 315–329. doi:10.1037/a0034027
- Roberts, R., & Edwards, M. C. (2016). Transforming students’ global knowledge and perspectives through international service-learning (ISL): How U.S. university agriculture students made sense of their lived experiences over time. *Journal of International Agricultural & Extension Education*, 23(3). doi:10.5191/jiaee.2016.23301
- Roberts, T. G., Harder, A., & Brashears, M. T. (Eds). (2016). *American Association for Agricultural Education national research agenda: 2016-2020*. Gainesville, FL: Department of Agricultural Education and Communication.
- Salisbury, M. H., Umbach, P. D., Paulsen, M. B., & Pascarella, E. T. (2009). Going global: Understanding the choice process of the intent to study abroad. *Research in Higher Education*, 50, 119–143. doi:10.1007/s11162-008-9111-x
- Towsic, M. L. (n.d.). Executive summary. *University of Minnesota survey: Study abroad curriculum integration*. Retrieved from [www.umabroad.umn.edu/ci/docs/evaluation/surveys/01\\_02/facadv\\_exec\\_sum.pdf](http://www.umabroad.umn.edu/ci/docs/evaluation/surveys/01_02/facadv_exec_sum.pdf)
- Trochim, W. (2001). *The research methods knowledge base* (2nd ed). Cincinnati, OH: Atomic Dog Publishing.

Zhai, L., & Scheer, S. D. (2004). Global perspectives and attitudes towards cultural diversity among summer agriculture students at the Ohio State University. *Journal of Agricultural Education*, 45(2), 39–51. doi:10.5032./jae.2004.02039



## **Involving agriculture faculty in study abroad: An examination of structural relationships between personal dimension variables in involvement**

Shelli D. Rampold, University of Florida  
Melissa Cater, Louisiana State University  
J.C. Bunch, University of Florida  
J. Joey Blackburn, Louisiana State University

### **Abstract**

*Faculty involvement in study abroad can influence significantly student participation in study abroad programs. However, faculty involvement in study abroad can be limited by institutional, professional, and personal factors. This study was conducted as part of a larger study to examine the relationship between and predictive nature of personal dimension variables on agriculture teaching faculty involvement in study abroad. Results of this study suggest the personal factors influencing agriculture faculty involvement in study abroad include their perception of the knowledge, skill, and ability (KSA) outcomes of study abroad, their awareness of study abroad programs and procedures, and their prior international experiences (PIE). The effect of agriculture faculty perception of the KSA outcomes of study abroad on their involvement in study abroad is mediated by their perception of the importance of those KSA outcomes for professionals in their field. Further, agriculture faculty perceived importance of KSA outcomes was moderated by PIE. Recommendations for future practice include providing professional development and training to increase faculty awareness of study abroad, as well as increase opportunities for agriculture faculty to gain international experience. Future research should be conducted to replicate this study with agriculture faculty at other institutions, and should examine relationships between factors in the professional and institutional dimensions.*

Key Terminology: study abroad, agriculture faculty, faculty involvement, personal factors

### **Introduction**

Initiatives to produce globally competent students have transpired across many U.S. institutions over the past decade (ACE, 2012; Green, 2012). As a means of supplementing on-campus initiatives to internationalize the educational experience, efforts have been directed to the development and promotion of study abroad opportunities (ACE, 2012; Childress, 2009). While a steady increase in student participation in study abroad programs has been observed each year, there remains room for growth in study abroad participation rates (IIE, 2016). Much of the increase in numbers of students studying abroad may be attributed to an observed shift from traditional, semester long programs to short-term (i.e., one to six weeks) faculty-led programs (Dwyer, 2004; IIE, 2016; McCabe, 2001; Zamastil-Vondrova, 2005).

Although faculty involvement may still be critical to student participation in long term exchanges, the increase in student interest in short-term, faculty led study abroad programs demonstrates a more pressing need to involve faculty. In addition to leading study abroad programs, faculty involvement in study abroad is needed regarding dissemination of study abroad information to students, encouraging study abroad participation, and assisting students

through the process of studying abroad (Lukosius & Festervand, 2013; O’Hara, 2009; Umbach & Wawrzynski, 2005). Moreover, Green and Olson (2003) identified the engagement of faculty as a driving force behind successful internationalization overall, and noted that this engagement encompasses teaching, research, service, and advising appointments of faculty. As such, a comprehensive approach to examining faculty involvement in study abroad is needed. However, in much of the research pertaining to the involvement of faculty study in abroad programs, involvement has been defined as faculty participation in leading a study abroad program for students. Considering the other activities in which faculty can participate and facilitate student participation in study abroad, future research is needed to examine faculty involvement in this respect and the factors influencing their involvement.

### Literature Review and Conceptual Framework

Wade and Demb’s (2009) Faculty Engagement Model (FEM) was modified by the researchers in a prior study to propose a comprehensive framework for explaining faculty active involvement in study abroad (Authors, n.d.). Per this model, the targeted engagement behavior included the active involvement of faculty in study abroad activities. Further, institutional, personal, and professional level factors influencing faculty involvement in study abroad were identified as influential (Authors, n.d.). For the purposes of this study, specific variables within the personal dimension were proposed vis-à-vis an extensive review of literature and incorporated as an expansion of the original model developed by the researchers (see Figure 1).

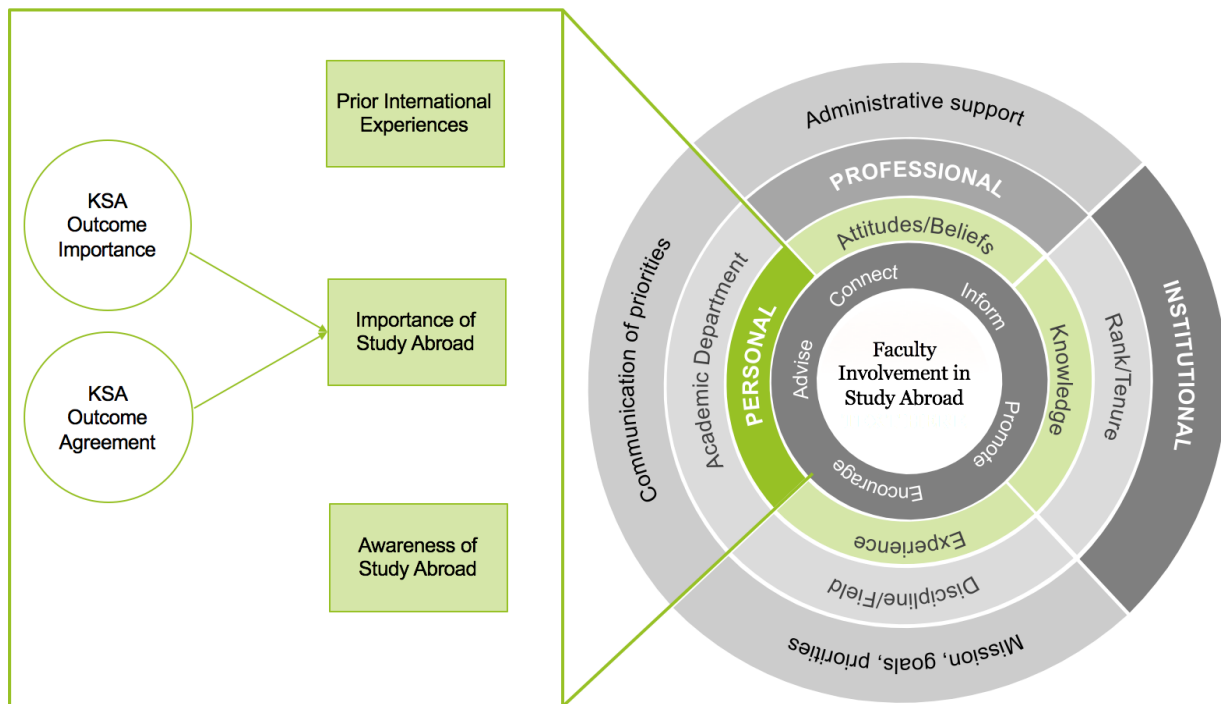

Figure 1. Personal dimension factors influencing faculty involvement in study abroad.

#### Personal Dimension

The personal dimension includes factors that pertain to faculty beliefs and attitudes, personal experience, and demographic characteristics (Authors, n.d; Wade & Demb, 2009). The variables

within the personal dimension hypothesized to influence faculty involvement in study abroad include (a) faculty attitudes beliefs regarding the importance of study abroad, including their perceptions of knowledge, skill, and ability (KSA) outcomes produced by study abroad and the importance of those KSAs for professionals in their field; (b) faculty awareness and knowledge regarding study abroad opportunities for students, the international programs office through which students study abroad, and study abroad policies and procedures; and (c) faculty prior international experience (PIE), including both personal and professional experiences (see Figure 1).

**Faculty beliefs and attitudes.** Faculty perceptions of the importance of study abroad may influence positively or negatively their degree of involvement in study abroad activities. If faculty perceive studying abroad as an effective means of producing learning outcomes among students, as well as perceive those outcomes as important for students to develop, they will be more likely to engage in promoting, encouraging and facilitating study abroad participation among their students (Green & Olsen, 2003; NSSE, 2008; Paus & Robinson, 2008). However, faculty may be less inclined to engage in study abroad activities if they do not perceive studying abroad as a valuable endeavor for students (Green & Olsen, 2003). Data from the National Survey of Student Engagement (NSSE) (2008) demonstrated a 20 percent increase in student study abroad participation per one-point increase in faculty response on a Likert-type scale rating of importance of study abroad. Unfortunately, O'Hara (2009) reported only 43 percent of U.S. faculty perceived study abroad as being important for students. Considering a 16.5 percent annual growth rate in study abroad participation is needed to achieve the national study abroad goals by the end of the decade (IIE, 2016b), further examination of faculty perceptions of study abroad importance is warranted.

**Prior international experience.** The international experience acquired by faculty has been found to influence significantly faculty personal attitudes and beliefs, faculty attitudes and behaviors in their professional setting, and the attitudes and behaviors of their students (ACE, 2012; Akpan & Martin, 1996; Bond, 2003; Green & Olsen, 2003; Hulstrand, 2009; O'Hara, 2009; SRI, 2002). Gains in international experience can influence faculty perception of internationalization overall, as well as their involvement in study abroad. In a study conducted with agriculture faculty, Akpan and Martin (1996) found that faculty who had traveled to a foreign country held more positive perceptions of internationalizing the agricultural education curriculum than faculty who did not have international experience. Additionally, faculty who have lived, traveled, or worked abroad have been found to be more inclined to incorporate international components into their teaching, research, and service responsibilities (ACE, 2012; Bond et al., 2003; Green & Olsen, 2003).

In a study conducted to examine the outcomes of the U.S Fulbright Scholar Program, the largest U.S exchange program for research and teaching professionals, the majority of faculty participants (a) developed a greater understanding of their host country, (b) shared information about their host country with colleagues, (c) continued to collaborate with host country or institutional colleagues, and (d) incorporated their experiences into their curricula or teaching methods (SRI, 2002). Regarding the impact of faculty international experiences on their involvement in study abroad, Hulstrand (2009) found that faculty members' prior international experiences influenced their degree of involvement in study abroad activities. Further, students

who had more internationally involved and experienced professors were more likely to pursue an international experience themselves (Hulstrand, 2009). Similarly, in a follow up study with faculty Fulbright participants, O'Hara (2009) found that 80 percent of the participating faculty later encouraged their students to study abroad.

Faculty international experience may also assist faculty who choose to lead a study abroad program. Goode (2008) examined the informal preparation of faculty study abroad directors and found that the personal international experiences of faculty better prepared them to lead students abroad. The types of international experiences these faculty members had acquired included (a) participating in a study abroad program as a student, (b) attending a seminar or international conference abroad, (c) studying a foreign language abroad, (d) working or volunteering in another country, and (e) conducting research abroad. Some faculty in this study also noted that the most helpful international experience they had acquired was their first experience as a study abroad director (Goode, 2008). Conversely, Woodruff (2009) found that increased prior international experience among faculty did not directly translate into increased promotion of study abroad opportunities by faculty. Faculty in this study who had some degree of international experience held positive attitudes toward study abroad, but they did not encourage students to study abroad more so than faculty with less international experience (Woodruff, 2009). The inconclusive findings observed in prior research in this area warrants further examination of the relationship between faculty international experience and their involvement in study abroad.

**Faculty knowledge and awareness.** The extent to which faculty are involved in study abroad may also be explained by their degree of awareness of study abroad programs, knowledge of the administrative policies and processes associated with study abroad, and their familiarity with the international programs office on campus (Bond et al., 2003; Doyle et al. 2010; Lukosius & Festervand, 2013; Woodruff, 2009). Lukosius and Festervand (2013) examined students' decision process to study abroad and identified faculty knowledge of administrative procedures as necessary to help students move through the final steps of the study abroad process and reduce the likelihood they will drop out at this point. However, faculty lack of awareness of study abroad has been reported previously as an inhibiting factor in faculty study abroad involvement (Bond et al., 2003; Doyle et al., 2010). Moreover, faculty knowledge and awareness may counteract factors that would otherwise motivate faculty involvement in study abroad. For example, faculty knowledge may explain why Woodruff (2009) found no differences in faculty involvement based on their prior international experiences. Faculty in this study who had international experiences had positive perceptions of study abroad, but they reported having a lack of knowledge and awareness of study abroad opportunities available to their students (Woodruff, 2009). As such, examination of the relationships between factors influencing faculty involvement is needed to better understand the complex interactions of these factors and how they influence faculty involvement.

***Personal interest in leading a study abroad program.*** Faculty involvement in study abroad was operationalized in this study to include a range of faculty activities in addition to leading a study abroad programs. However, as increasing student participation in study abroad is highly dependent upon faculty willing to lead study abroad programs (Stohl, 2007), faculty interest in leading a study abroad program deserves examination. Barriers to faculty involvement in leading study abroad programs identified in prior studies include (a) time constraints, (b)

perceived lack of support from administration, and (c) lack of guidance and formal preparation (Dewey & Duff, 2009; Goode, 2008). In a study conducted by Dewey and Duff (2009) to examine barriers to faculty involvement in leading study abroad programs, faculty emphasized the issue of time required to develop or direct a study abroad program. To this, faculty noted that it is discouraging or even off putting when administration views faculty participation in study abroad as a merely a fringe benefit, especially considering the amount of time and work required to do so (Dewey & Duff, 2009). Additionally, faculty in this study identified the lack of useful templates or guidelines for initiating a new study abroad program as problematic (Dewey & Duff, 2009). Similarly, Goode (2008) examined the formal and informal preparation of faculty study abroad directors and found faculty had little to no formal preparation, nor did they perceive that their academic program supported their consideration of leading a study abroad program.

### **Purpose and Objectives**

The purpose of this study was to examine factors within the personal dimension that may influence agriculture teaching faculty involvement in study abroad. This research study addresses national research priority three: Workforce that addresses the challenges of the 21<sup>st</sup> century (Stripling & Ricketts, 2016). The objectives included in this study were to (a) describe personal factors of agriculture teaching faculty, including perception of study abroad importance and personal interest in leading a study abroad program; and (b) develop a model to explain agriculture teaching faculty involvement in study abroad in terms of personal dimension factors.

### **Methodology**

#### **Population**

The population for this study consisted of all faculty employed in the colleges of agriculture at Louisiana State University (LSU;  $N = 173$ ) and University of Florida (UF;  $N = 388$ ) who held a formal teaching appointment at the time the study was conducted (combined  $N = 561$ ). Frame error was discovered during analysis, and a total of 50 faculty were removed due to not meeting the criteria of holding a formal teaching appointment. Additionally, one faculty member opted out and 12 faculty were removed due to incomplete responses, which yielded a revised sample of 498. Useable responses were collected from 184 faculty for a 37% response rate.

Faculty participants in this study were employed in colleges of agriculture at LSU ( $f = 54$ ; 29%) and University of Florida ( $f = 130$ ; 71%). Regarding professional status, more faculty held the rank of full professor ( $f = 74$ ; 40%) and the majority were tenured ( $f = 109$ ; 59%). Additionally, slightly more faculty were males ( $f = 103$ ; 56%), and the majority were White, Non-Hispanic ( $f = 149$ ; 81%)

#### **Data Collection**

An electronic mail (email) listserv of LSU faculty and UF faculty was obtained from college administrators and used to distribute an online questionnaire via Qualtrics email service. The email to faculty included a description of the study and a link to the questionnaire. A modified approach to Dillman, Smyth, and Christians' (2009) Tailored Design Method was used to collect responses. A second request for participation was sent to non-responding faculty following the

initial contact. A third reminder and request for participation was sent one week following the second reminder. Due to lack of response, a fourth and final reminder was sent.

## **Instrumentation**

An original instrument was developed by the researcher to assess agriculture teaching faculty involvement in and perceptions of study abroad for students. To ensure content validity, an extensive review of the literature was conducted to identify (a) activities associated with study abroad programs in which faculty can be or are involved; (b) the knowledge, skills and abilities (KSAs) most frequently identified as being outcomes of study abroad programs; and (c) institutional and individual-level factors found to influence agriculture faculty involvement in and perceptions of study abroad programs, as well as (d) factors that influence agriculture faculty involvement and perceptions of other components of internationalizing higher education that may be transferrable to study abroad. The developed questionnaire was then reviewed for content validity by an expert panel consisting of the researcher and faculty with collective proficiencies in study abroad program development and instrument development. The panel deemed the instrument acceptable. Lastly, *post hoc* reliability estimates were calculated using Cronbach's alpha.

Seven sections of the survey instrument were used for data analysis in this study including (a) involvement in study abroad programs, (b) perceived importance of study abroad for students, (c) agreement with KSAs as outcomes of studying abroad, (d) perceived importance of KSA outcomes, (e) awareness of study abroad programs, (f) personal interest in leading a study abroad program for students, and (g) and the prior international experience (PIE) acquired by agriculture teaching faculty.

The first section of the instrument was designed to assess the active involvement of agriculture teaching faculty in activities associated with increasing student participation in study abroad programs. To measure involvement, faculty responses to check all that apply items were coded (0 = item not selected; 1 = item selected), and a composite score was computed. Faculty participants were asked to indicate by checking all that apply which of the 12 activities they have conducted. Examples of the activities listed include "I have encouraged students I teach/advise to study abroad", "I have used time in class to inform students I teach of study abroad opportunities in the College of Agriculture", and "I have helped design a study abroad program for students."

The second section of the instrument was designed to assess agriculture faculty perceived importance of study abroad for students. Faculty participants were asked to indicate their level of agreement with the following statement: "I believe study abroad is important for students." Responses were collected using a 6-point Likert-type scale (1 = *disagree strongly*, 2 = *disagree*, 3 = *disagree slightly*, 4 = *agree slightly*, 5 = *agree*, 6 = *agree strongly*). Real limits were set to interpret responses (1.00 to 1.50 = *disagree strongly*; 1.51 to 2.50 = *disagree*; 2.51 to 3.50 = *disagree slightly*; 3.51 to 4.50 = *agree slightly*; 4.51 to 5.50 = *agree*; = 5.51 to 6.00 = *agree strongly*).

The third section of the instrument was designed to measure agriculture teaching faculty perceptions of the KSAs students develop as a result of studying abroad. The KSA Outcome

Agreement construct comprised seven items that were identified through the review of literature as the KSAs most frequently reported as student outcomes of study abroad. Faculty were asked to indicate their agreement with statements such as “studying abroad increases students’ acceptance of other cultures” and “studying abroad increases students’ knowledge of global issues”. Responses were collected using a 6-point Likert-type scale (1 = *disagree strongly*, 2 = *disagree*, 3 = *disagree slightly*, 4 = *agree slightly*, 5 = *agree*, 6 = *agree strongly*). Real limits were set to interpret responses (1.00 to 1.50 = *disagree strongly*; 1.51 to 2.50 = *disagree*; 2.51 to 3.50 = *disagree slightly*; 3.51 to 4.50 = *agree slightly*; 4.51 to 5.50 = *agree*; = 5.51 to 6.00 = *agree strongly*). A mean score was created to represent faculty agreement with KSAs as outcomes of study abroad. The internal consistency reliability for this scale was  $\alpha = .92$ .

The fourth section of the instrument was designed to measure agriculture teaching faculty perceptions of the importance of select KSAs for professionals in their field. The KSA Outcome Importance construct comprised 10 items intended to mirror the items in the KSA Agreement construct. Faculty were asked to indicate their agreement with statements such as “being accepting of other cultures is important for professionals in my field” and “having knowledge of global issues is important for professionals in my field”. Responses were collected using a 6-point Likert-type scale (1 = *disagree strongly*, 2 = *disagree*, 3 = *disagree slightly*, 4 = *agree slightly*, 5 = *agree*, 6 = *agree strongly*). Real limits were set to interpret responses (1.00 to 1.50 = *disagree strongly*; 1.51 to 2.50 = *disagree*; 2.51 to 3.50 = *disagree slightly*; 3.51 to 4.50 = *agree slightly*; 4.51 to 5.50 = *agree*; = 5.51 to 6.00 = *agree strongly*). A mean score was created to represent agriculture teaching faculty perceptions of KSA importance. The internal consistency reliability for this scale was  $\alpha = .94$ .

The fifth section of the instrument was designed to assess agriculture teaching faculty knowledge and awareness of study abroad programs, policies, and procedures. The Study Abroad Awareness construct comprised five items representative of the areas in which faculty need to be familiar to facilitate student participation in study abroad programs. Faculty were asked to indicate their agreement with statements such as “I am aware of study abroad opportunities for my students” and “I am familiar with the process of transferring study abroad credits to students’ degree plan at home”. Responses were collected using a 6-point Likert-type scale (1 = *disagree strongly*, 2 = *disagree*, 3 = *disagree slightly*, 4 = *agree slightly*, 5 = *agree*, 6 = *agree strongly*). Real limits were set to interpret responses (1.00 to 1.50 = *disagree strongly*; 1.51 to 2.50 = *disagree*; 2.51 to 3.50 = *disagree slightly*; 3.51 to 4.50 = *agree slightly*; 4.51 to 5.50 = *agree*; = 5.51 to 6.00 = *agree strongly*). A mean score was created to represent agriculture teaching faculty awareness of study abroad programs. The internal consistency reliability for this scale was  $\alpha = .87$ .

The sixth section of the instrument was designed to assess the prior international experience (PIE) of agriculture teaching faculty. To measure PIE, faculty responses to check all that apply items were coded (0 = item not selected; 1 = item selected), and a composite score was computed. Faculty participants were asked to indicate by checking all that apply which of the 13 experiences they had acquired. Examples of the activities listed include “I have participated in international activities on campus”, “I have worked in a country other than the U.S.”, and “I have participated in a study abroad program for faculty.”

Lastly, faculty were asked to indicate their personal interest in leading a study abroad program for students. Responses were collected using a 4-point Likert-type scale (1 = *definitely not*, 2 = *probably not*, 3 = *probably yes*, 4 = *definitely yes*).

## **Data Analysis**

Objective one was descriptive in nature and was reported using means and standard deviations. For objective two, structural equation modeling (SEM) was employed to examine structural relationships between variables predicted to influence faculty involvement in study abroad. SEM analysis was selected due to its predictive ability, as well as the ability to examine the mediating effect of variables for which a direct effect may not be observed. SEM procedures were conducted using the MPlus 7.31 software package. Indices of absolute fit included the standardized root mean square residual (SRMR) and Steiger's (1999) root mean square error of approximation (RMSEA), with smaller values indicating a better fit to the data. SRMR values range from 0 to 1, with values less than .08 indicating a good fit (Hu & Bentler, 1999); RMSEA values below .10 indicate a good fit, and values below .05 indicate a very good fit (Steiger, 1990). Indices of comparative fit included the comparative fit index (CFI) and the Tucker-Lewis Index (TLI). The CFI ranges from 0 to 1, with values exceeding .95 as indicative of a good fit (Hu & Bentler, 1999). The TLI, or non-normed fit index is a measure of incremental fit that attempts to (a) capture the percentage improvement of a hypothesized model over the null model, (b) adjust this improvement for the number of parameters in the hypothesized model. Values exceeding .95 indicate good fit (Hu & Bentler, 1999).

## **Findings**

### **Objective One**

Objective one sought to describe agriculture teaching faculty perceptions of the importance of study abroad for students, as well as their personal interest in leading a study abroad program. Descriptive information for other variables examined in this study were reported previously in a prior study and were, therefore, not reported in this study. Regarding agriculture teaching faculty perceptions of the importance of study abroad, faculty agreed that study abroad was important for students ( $M = 5.17$ ;  $SD = .86$ ). Regarding their personal interest in leading a study abroad program for student, agriculture faculty indicated low, but possible interest ( $M = 2.71$ ;  $SD = .94$ ).

### **Objective Two**

Objective two sought to develop a model to explain agriculture teaching faculty involvement in study abroad in terms of personal factors. The dependent variable was faculty involvement in study abroad. Independent variables included agreement with KSAs as outcomes of study abroad, study abroad awareness, and prior international experiences. Possible mediating variables included perception of the importance of KSA outcomes and perceived importance of study abroad.

The chi-square statistic for the full mediation model (see Table 1, M2) was statistically significant. The absolute fit index for SRMR was borderline, and RMSEA was within Steiger's



recommended range of values for good fit of the data. Further, the comparative fit indices CFI and TLI did not meet the recommended cutoff value of .95 (Hu & Bentler, 1999; see Table 1, M2). As such, this model was not considered a good fit and a partial mediation model was examined. The chi-squared statistic was significant for the first partial mediation model. The absolute and comparative indices showed mixed results with slight improvements to SRMR and TLI; however, the overall model did not suggest a good fit for the data (see Table 1, M3). As such, two exploratory partial mediation models were examined (see Table 1, M4, M5). Chi-square statistic was significant for both models. Again, neither absolute nor comparative indices for either model suggested a well-fitted model. The absolute index SRMR, as well as the comparative indices CFI and TLI, were slightly better for the second exploratory partial mediation model (see Table 1, M5). As such, this model was deemed the best fit of the models examined (see Figure 2).

Table 1.  
*Full and Partial Mediation Exploratory Model Fit*

Model	$\chi^2$	<i>df</i>	RMSEA <sup>a</sup>	CFI	TLI	SRMR
Null (M1)	69.01	19	.092	.908	.869	.143
Full (M2)	764.80	272	.093	.843	.827	.092
Partial 1 (M3)	742.56	269	.091	.849	.832	.080
Partial 2 Exploratory (M4)	751.64	270	.092	.847	.830	.089
Partial 3 Exploratory (M5)	738.53	270	.091	.851	.834	.083

*Note.* RMSEA, Root-Mean-Square Error of Approximation; CFI, Comparative Fit Index; TLI, Tucker-Lewis Index; SRMR, Standardized Root-Mean-Square Residual.

<sup>a</sup> 90% confidence interval

\*\*\* $p < 0.001$

All factors in the model (see Figure 2) contributed to faculty involvement in study abroad to some degree. Faculty awareness of study abroad had a direct effect on faculty involvement in study abroad. The effect of faculty agreement with KSAs as outcomes of study abroad on their involvement in study abroad was partially mediated by their perception of the importance of KSA outcomes for professionals in their field, as well as by their perception of the overall importance of study abroad. Additionally, faculty perception of the importance KSA outcomes for professionals in their field was partially moderated by their prior international experiences (see Figure 2).

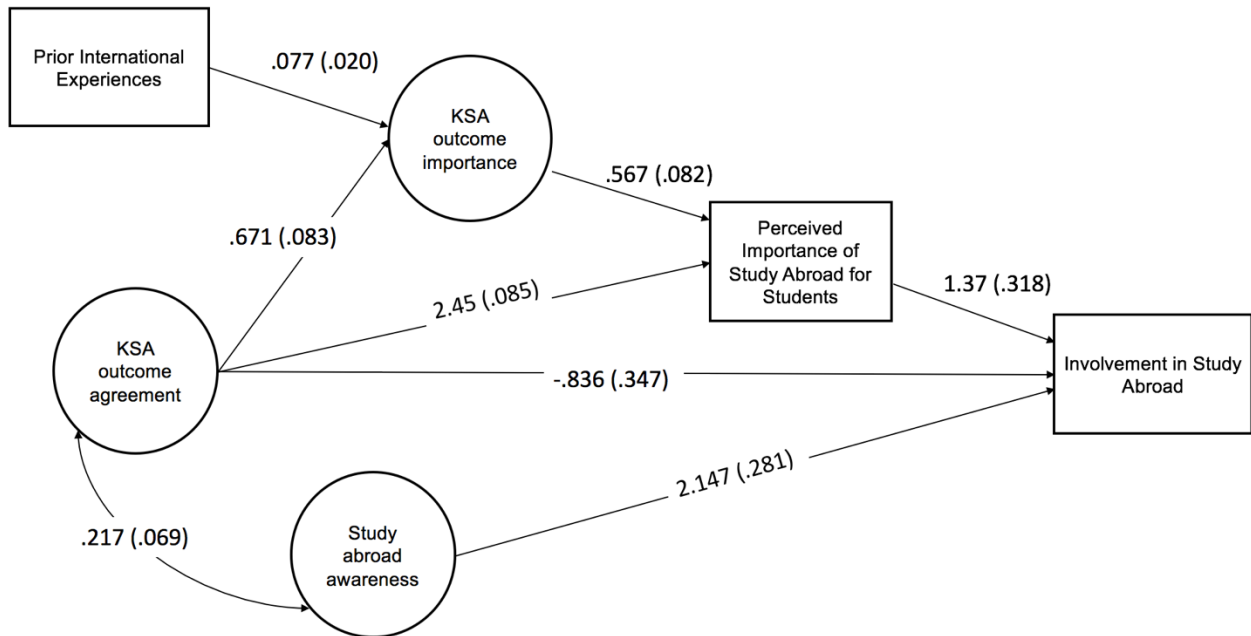

Figure 2. Partial mediation model for personal dimension factors influencing faculty involvement in study abroad.

### Conclusions and Recommendations

While none of the models met the criteria for a well-fitted model, all of the models exhibited elements of close fit in some areas with marginal fit in other areas. Per the accepted model, the following personal dimension factors predicted agriculture teaching faculty involvement in study abroad: (a) faculty agreement with KSAs as being outcomes of study abroad; (b) faculty perceived importance of KSA outcomes for professionals in their field; (c) faculty perception of the overall importance of study abroad for students; (d) faculty awareness of study abroad programs, policies, and procedures; and (e) faculty PIE.

The effect of agriculture teaching faculty agreement with KSAs as being outcomes of study abroad on their involvement in study abroad was partially mediated by their perceptions of the importance of those KSA outcomes and the overall importance of study abroad for students. As indicated by the relationships observed in this model, agriculture faculty who believe studying abroad produces KSA outcomes among students will perceive studying abroad as more important and will be more likely to be involved if they also perceive those KSA outcomes as important for professionals in their field. Consistent with prior research, the findings of this study support the notion that convincing faculty of the value of study abroad programs can influence positively their involvement in efforts to increase student participation in such programs (Green & Olsen, 2003; Paus & Robinson, 2008). As such, future research should be conducted to examine why agriculture faculty do or do not perceive select KSAs as being outcomes of study abroad, as well as to examine why agriculture faculty do or do not perceive those KSA outcomes as being important for professionals in their field. Considering the high potential for the global nature of academic disciplines to influence faculty perceptions (Ellingboe, 1988; Bond et al.,

2003), it may also be beneficial to include academic discipline in future models to explain faculty perceptions of the importance of KSA outcomes.

Additionally, faculty perceptions of the importance of KSA outcomes was moderated by their prior international experience. Consistent with prior research, agriculture faculty in this study are more likely to perceive KSA outcomes of study as important for professionals in their field if they have acquired international experiences themselves (ACE, 2012; Akpan & Martin, 1996; O'Hara, 2009). As such, efforts should be directed toward increasing the international experience of faculty. Qualitative inquiry to explore how specific international experiences have impacted faculty beliefs toward study abroad programs could aid in determining the types of opportunities that should be offered for faculty.

Agriculture faculty awareness of study abroad had a direct effect on their involvement. As consistent with prior research, agriculture faculty are more likely to be involved in study abroad if they are aware of study abroad opportunities and processes associated with study abroad (Bond et al., 2003; Doyle et al. 2010; Woodruff, 2009). Therefore, future efforts should be directed toward faculty professional development and training regarding study abroad. Such efforts may include informational sessions or seminars designed to inform faculty of upcoming study abroad programs within their departments and communicate to faculty how those programs can benefit their students.

The complexity of the model employed in this study causes limitations regarding the power of this model. As such, it would be beneficial to explore separate, more simplified models in future research to better explain the personal dimension factors influencing faculty involvement in study abroad. Moreover, considering the limitation posed by the small sample size in this study, it is recommended future studies of this nature be conducted with a larger sample size that includes agriculture faculty from other institutions. Finally, as this the purpose of this study was to explore relationships between variables in the personal dimension, future research should be conducted to examine the relationships between variables in the professional and institutional dimensions to further develop and test the conceptual model for faculty involvement in study abroad (see Figure 1).

## References

- Akpan, M., & Martin, R. A. (1996). Perceptions and activities of agricultural education professors in U.S. institutions of higher education regarding internationalization of the agricultural education curriculum. *Journal of International Agricultural and Extension Education*, 3(2), 63–71. doi:10.5191/jiaee.1996.03208
- American Council on Education (ACE). (2012). *Mapping internationalization on U.S. campuses: 2012 edition*. Washington, DC: American Council on Education. Retrieved from <http://www.acenet.edu/news-room/Documents/Mapping-Internationalizationon-US-Campuses-2012-full.pdf>
- Bond, S. L., Qian, J., & Huang, J. (2003). The role of faculty in internationalizing the undergraduate curriculum and classroom experience. *Canadian Bureau for International Education*, 8, 1–20. Retrieved from <http://files.eric.ed.gov/fulltext/ED549872.pdf>

- Childress, L. K. (2009). Internationalization plans for higher education institutions. *Journal of Studies in International Education*, 13(3), 289–309. doi:10.1177/1028315308329804
- Dewey, P., & Duff, S. (2009). Reason before passion: Faculty views on internationalization in higher education. *Higher Education*, 58(4), 491–504. doi:10.1007/s10734-009-9207-z
- Dillman, D. A., Smyth, J. D., & Christian, L. M. (2009). *Internet, mail, and mixed-mode surveys: The tailored design method*. Hoboken, NJ: John Wiley & Sons, Inc.
- Doyle, S., Gendall, P., Meyer, L. H., Hoek, J., Trait, C., McKenzie, L., & Loorparg, A. (2010). An investigation of factors associated with student participation in study abroad. *Journal of Studies in International Education*, 14(5), 471–490. doi:10.1177/1028315309336032
- Dwyer, M. M. (2004). More is better: The impact of study abroad program duration. *Interdisciplinary Journal of Study Abroad*, 10, p. 151–163.
- Engle, L., & Engle, J. (2004). Assessing language acquisition and intercultural sensitivity development in relation to study abroad program design. *The Interdisciplinary Journal of Study Abroad*, 10, 219–236. Retrieved from <https://eric.ed.gov/?id=EJ891458>
- Green, M. F., & Olsen, C. L. (2003). *Internationalizing the campus: A user's guide*. Washington DC: American Council on Education. Retrieved from <http://www.d.umn.edu/vcaa/intz/users%20guide.pdf>
- Hu, L., & Bentler, P. M. (1999). Cutoff criteria for fit indexes in covariance structure analysis: Conventional criteria versus new alternatives. *Structural Equation Modeling*, 6(1), 1–55. doi: 10.1080/10705519909540118
- Hulstrand, J. (2009). Attracting faculty to education abroad. *International Educator*, 18(5), 48–51. Retrieved from [https://www.nafsa.org/\\_/File/\\_/sepoct09\\_edabroad.pdf](https://www.nafsa.org/_/File/_/sepoct09_edabroad.pdf)
- Institute of International Education (IIE). (2016). *Open doors report*.
- Lukosius, V., & Festervand, T. A. (2013). Marketing study abroad programs: A student recruitment model. *American Journal of Business Education*, 6(5), 483–494. doi:10.19030/ajbe.v6i5.8038
- McCabe, L. T. (2001). Globalization and internationalization: The impact on education abroad programs. *Journal of Studies in International Education*, 5(2), 138–145.
- National Survey of Student Engagement (NSSE). (2008). *Promoting engagement for all students: The imperative to look within*. Bloomington, IN: Indiana University Center for Postsecondary Research. [http://nsse.indiana.edu/NSSE\\_2008\\_Results/docs/withhold/NSSE2008\\_Results\\_revised\\_11-14-2008.pdf](http://nsse.indiana.edu/NSSE_2008_Results/docs/withhold/NSSE2008_Results_revised_11-14-2008.pdf)

- O'Hara, S. (2009). *Vital and overlooked: The role of faculty in internationalizing U.S. campuses* (White Paper Issue No. 6). Retrieved from Institute of International Education website: <http://www.iie.org/en/Research-and-Publications/Publications-and-Reports/IIE->
- Paus, E., & Robinson, M. (2008). Increasing study abroad participation: The faculty makes the difference. *The Interdisciplinary Journal of Study Abroad*, 17, 33–49. Retrieved from <http://files.eric.ed.gov/fulltext/EJ899295.pdf>
- Schwietz, M. (2006). *Internationalization of the academic profession: An exploratory study of faculty attitudes, beliefs, and involvement at public universities in Pennsylvania* (Unpublished doctoral dissertation). University of Pittsburgh, Pittsburgh, PA.
- Stanford Research Institute (SRI). 2002. *U.S Fulbright Scholar program outcome assessment*. Stanford, CA: Author. Retrieved from <https://eca.state.gov/files/bureau/fulbright-us-scholar-one-pager-aug-2002.pdf>
- Steiger, J. H. (1990). Structural model evaluation and modification: An interval estimation approach. *Multivariate Behavioral Research*, 25(2), 173–180. doi:10.1207/s15327906mbr2502\_4
- Stripling, C. T., & Ricketts, J. C. (2016). Research priority 3: Sufficient scientific and professional workforce that addresses the challenges of the 21st century. In T. G. Roberts, A. Harder, & M. T. Brashears (Eds.), *American Association for Agricultural Education national research agenda: 2016-2020* (pp. 29–35). Gainesville, FL: Department of Agricultural Education and Communication
- Umbach, P. D., & Wawrzynski, M. R. (2005). Faculty do matter: The role of college faculty in student learning and engagement. *Research in Higher Education*, 46(2), 153–183. doi:10.1007/s11162-004-1598-1
- Wade, A., & Demb, A. (2009). A conceptual model to explore faculty community engagement. *Michigan Journal of Community Service Learning*, 15(2), 5–16. Retrieved from <https://u.osu.edu/demb.1/files/2008/09/Wade-Demb-MJCLS-vz7pf0.pdf>
- Woodruff, G. A. (2009). *Internationalizing the curriculum and campus paper series*. Minneapolis, MN: University of Minnesota Office of International Programs. Retrieved from [https://global.umn.edu/icc/documents/woodruff\\_curriculum\\_integration.pdf](https://global.umn.edu/icc/documents/woodruff_curriculum_integration.pdf)
- Zamastil-Vondrova, K. (2005). Good faith or hard data? Justifying short-term programs. *International Educator*, 14(1), 44–49.

## **Involving Agriculture Faculty in Study Abroad: A Descriptive and Comparative Analysis of Faculty Involvement in and Perceptions of Study Abroad Programs**

Shelli D. Rampold, University of Florida  
J.C. Bunch, University of Florida  
Melissa Cater, Louisiana State University  
J. Joey Blackburn, Louisiana State University

### ***Abstract***

*This descriptive and comparative study was conducted to explain agriculture teaching faculty involvement in and perception of study abroad. Further, faculty involvement and perceptions were compared based on the personal and professional characteristics of faculty. Findings of this study revealed that faculty were somewhat involved in study abroad activities. Regarding faculty perceptions of study abroad, faculty perceived study abroad outcomes as important but were less convinced that studying abroad was an avenue for producing those outcomes among students. Analysis of differences between groups yielded few significant findings, with the exception of the prior international experience acquired by faculty. Recommendations for future research include replication of this study with faculty from additional universities, as well as qualitative or mixed method approaches to further investigate inconclusive findings of this study.*

Key terminology: study abroad, agriculture faculty, faculty involvement

### **Introduction**

In light of the push to internationalize higher education and produce globally competent professionals, increasing student participation in study abroad programs has become adopted widely into the mission and strategic plans of higher education institutions (ACE, 2012). In prior studies, the outcomes observed among students who studied abroad included (a) increased global perspective, (b) greater cultural competence skills, (c) improved ability communicating and collaborating with diverse people groups, (d) increased self-confidence and self-efficacy in unfamiliar situations, (e) establishment of beneficial international networks, (f) greater interest in pursuing an internationally focused career, and (g) continued integration of study abroad experiences post program (Anderson, Lawton, Rexeisen, & Hubbard, 2006; Briers, Shinn, & Nguyen, 2010; Chieffo & Griffiths, 2004; Clark, Flaherty, Wright, & McMillen, 2009; Czerwionka, Artamonova, & Barbosa, 2015; Kehl & Morris, 2008; Parsons, 2010; Rowan-Kenyon & Niehaus, 2011; Sjoberg and Shabalina, 2010).

Factors identified in prior research as influential to student participation in study abroad has included the behaviors, attitudes, and involvement of university faculty (Lukosius & Festervand, 2013; O'Hara, 2009; Paus & Robinson; Stohl, 2007). While prior research has been conducted to examine faculty involvement and perceptions in other areas of internationalization (e.g. internationalizing the curriculum, international research collaboration), there remains a need for research specific to faculty involvement in study abroad. Moreover, faculty involvement has been operationalized in existing literature most frequently as faculty involvement leading a study abroad program. However, there exist other ways in which faculty can be involved in study

abroad (Lukosius & Festervand, 2013; O’Hara, 2009; Umbach & Wawrzynski, 2005). Examination of the full extent of faculty involvement, as well as examine factors influencing their involvement, is warranted.

### Literature Review and Conceptual Framework

Wade and Demb’s (2009) Faculty Engagement Model (FEM) was modified by the researchers via an extensive review of literature to propose a comprehensive framework for examining faculty involvement in study abroad (see Figure 1). For the purpose of this study, faculty engagement referred to faculty involvement in activities associated with student participation in study abroad programs. Per the proposed model, faculty involvement in study abroad can be influenced by sets of factors organized within the institutional, professional, and personal dimensions.

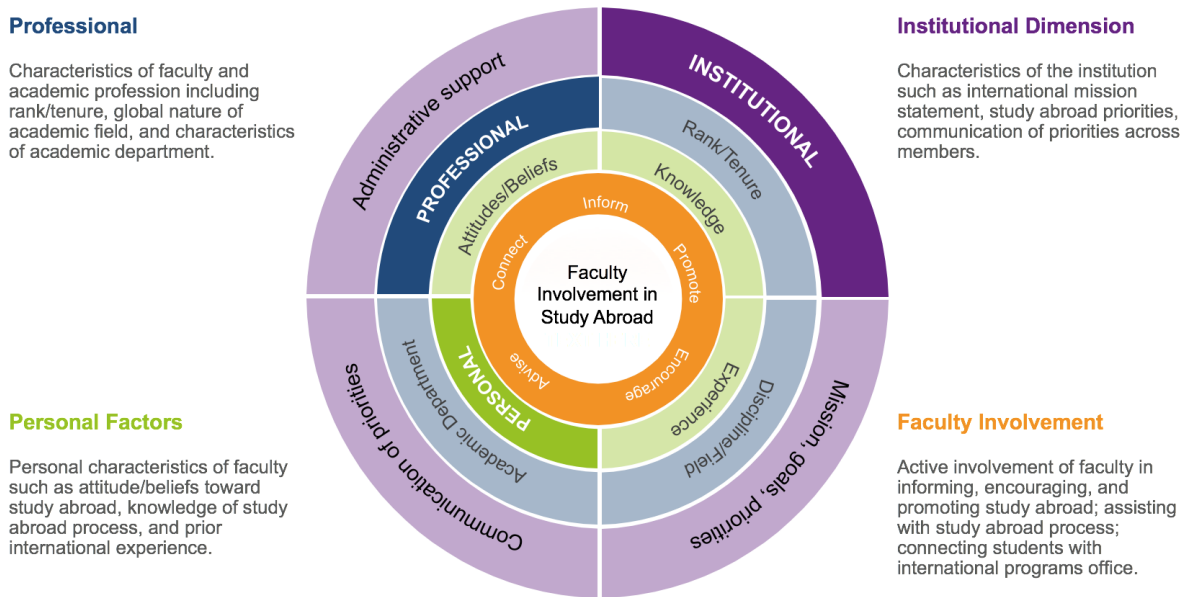

Figure. 1. Conceptual model to explain faculty involvement in study abroad.

The *institutional dimension* pertains to characteristics of the institution and the manner in which institutions establish and convey priorities (Authors, n.d; Wade & Demb, 2009). While many institutions have included international education into their mission statements and strategic plan priorities, the American Council on Education (ACE, 2012) reported mixed findings regarding the actualization of institutional goals and priorities in campus-wide practices. This gap between institutional rhetoric and actual practice may be attributed to inadequate institutional and administrative communication and support (ACE, 2012; Bond, Quian, & Huang, 2003; Dewey & Duff, 2009; Schwietz, 2006). The institutional dimension may also include the university tenure, promotion, and reward system. Despite significant growth in internationalization efforts among institutions between the years 2006 and 2011, the ACE (2012) reported no growth during these years in percentage of institutions with tenure and promotion policies inclusive of international work. The aggregate body of research on this topic suggested the contemporary reward system is one that serves as a barrier to faculty engagement in study abroad and other international

activities (ACE, 2012; Andreasen, 2003; Bendelier & Zawacki-Richter, 2015; Dewey & Duff, 2009; Ellingboe, 1998; Estes, Hansen, & Edgar, 2016; Finkelstein, Walker, & Chen, 2013).

The *professional dimension* comprises factors relevant to the professional characteristics of faculty, such as professional rank and status, the nature of faculty academic discipline or field of study, and support and priority among departmental faculty and administrators (Authors, n.d). Regarding the influence of academic discipline on faculty involvement in international activities, the teaching, research, and service priorities of faculty has been found to be contingent upon the needs and expectations of their respective discipline or academic department (Childress, 2007). This occurrence may serve as a barrier to the study abroad involvement of faculty in some departments due to some academic disciplines being inherently internationally focused and others having a largely domestic frame of reference (Bond et al., 2003; Green & Olsen, 2003).

The *personal dimension* includes factors that pertain to faculty beliefs and attitudes, personal experience, and demographic characteristics (Authors, n.d; Wade & Demb, 2009). Personal characteristics identified in prior studies as influencing faculty involvement in study abroad include (a) faculty beliefs regarding the importance of study abroad, (b) faculty knowledge and awareness of study abroad programs and associated procedures, and (c) prior international experience of faculty (Green & Olsen, 2003; NSSE, 2008; O'Hara, 2009; Paus & Robinson, 2008). Describing faculty attitudes and beliefs is especially critical to study abroad efforts due to the significant capacity of faculty to impact student participation in study abroad. Data from the National Survey of Student Engagement (NSSE; 2008) demonstrated a one-point increase in faculty response on a Likert-type scale rating of importance of study abroad was related to a 20 percent increase in student participation. Faculty beliefs also influence their direct involvement in study abroad. In prior studies, Green and Olson (2003) found faculty who did not perceive study abroad as valuable for students were less inclined to engage in study abroad activities and less likely to encourage students to study abroad (Green & Olsen; Paus & Robinson, 2008)

Faculty knowledge and awareness of study abroad may also influence their involvement. Lukosius and Festervand (2013) conducted an analysis of students' choice process to study abroad and identified ways in which faculty can facilitate students' progression through each stage of the process. The first two stages of the process involve student interest and gathering of study abroad program information. Faculty involvement in these stages include promoting study abroad programs, distributing information to students, and encouraging students to pursue available opportunities. The final two stages of the process are largely bureaucratic and thus require faculty/advisors to have adequate knowledge of the study abroad process to assist students (Lukosius & Festervand, 2013). However, faculty lack of awareness has been reported in prior studies as an inhibiting factor in their ability to assist students in the study abroad process (Bond et al., 2003; Doyle, Gendall, Meyer, Hoek, Trait, McKenzie, & Loorparg, 2010).

Lastly, the prior experience (PIE) of faculty may influence their degree of involvement in study abroad activities. In several studies, faculty who had lived, traveled, or worked abroad were found to be more inclined to incorporate international components into their teaching, research and service responsibilities (ACE, 2012; Bond et al., 2003; Green & Olsen, 2003). Conversely, Woodruff (2009) found the prior international experiences of faculty did not directly translate into increased promotion of study abroad opportunities. In this study, faculty with some degree



of international engagement had positive attitudes toward study abroad but were not necessarily more knowledgeable of study abroad opportunities nor more encouraging to students than faculty with less international experience (Woodruff, 2009). The inconclusive findings of prior research in this area suggest the need for further study regarding the influence of faculty international experience on their study abroad involvement.

### **Purpose and Objectives**

The primary purpose of this descriptive and comparative study was to examine agriculture teaching faculty involvement in study abroad at two land-grant universities. This research study addresses the national research priority area three: Workforce that addresses the challenges of the 21st century.

1. Describe agriculture teaching faculty in terms of their (a) involvement in study abroad; (b) agreement with the knowledge, skills and abilities (KSAs) students gain as outcomes of study abroad; (c) perceived importance of KSA outcomes of study abroad for professionals in their field; (d) awareness of study abroad opportunities and associated elements; (e) perceived priority placed on study abroad at the institutional, college, departmental, and collegial levels; and (f) prior international experience (PIE).
2. Compare agriculture teaching faculty by institutional affiliation on select characteristics of faculty.
3. Compare agriculture teaching faculty by tenure status on select characteristics of faculty.
4. Compare agriculture teaching faculty by professional rank (instructor, assistant professor, associate professor, full professor) on select characteristics of faculty.
5. Compare agriculture teaching faculty by gender on the characteristics select characteristics of faculty.
6. Compare agriculture teaching faculty by ethnicity on select characteristics of faculty.

### **Methodology**

The population for this study consisted of all faculty employed in colleges of agriculture at Louisiana State University (LSU;  $N = 173$ ) and the University of Florida (UF;  $N = 388$ ) who held a formal teaching appointment (combined  $N = 561$ ). Responses were collected from 246 of the 561 faculty for a 44 percent response rate. Frame error regarding faculty teaching appointment was discovered during analysis. A total of 50 faculty did not meet the *a priori* criteria and were removed from the study. One faculty member opted out and 12 faculty were removed due to incomplete responses, which yielded a revised sample of 498. Useable responses were collected from 184 faculty for a 37 percent response rate. Faculty in this study were employed in colleges of agriculture at LSU ( $f = 54$ ; 29%) and UF ( $f = 130$ ; 71%). Regarding professional rank (6 responses missing), more faculty held the rank of full professor ( $f = 74$ ; 40%). Additionally, the majority of faculty were tenured ( $f = 109$ ; 59%). Slightly more faculty

were males ( $f = 103$ ; 56%), and the majority were White, Non-Hispanic ( $f = 149$ ; 81%; responses missing from 8 participants).

As indicated in the review of literature, faculty involvement in and perceptions of study abroad may be shaped by the mission, priorities, and overall climate of the institution at which they are employed (ACE, 2012; Bond et al., 2003; Dewey & Duff, 2009; Schwietz, 2006). As such, the two 1862 land-grant institutions were purposively selected to gain a better understanding of the impact of institutional factors of faculty involvement in study abroad. Both universities have established goals pertaining to study abroad and have on-campus offices dedicated to international programs. However, the institutions differ in terms of strategic plan implementation and student study abroad participation rates.

A listserv of teaching faculty from LSU and UF was obtained from college administrators and used to distribute an online questionnaire to faculty via Qualtrics email service. A modified approach to Dillman, Smyth and Christians (2009) Tailored Design Method was used to collect responses from the faculty. A second request for participation was sent to faculty who had not yet responded one week following the initial contact. A third reminder and request for participation was sent one week following the second reminder. Due to low response rate, a fourth, and final, reminder was sent two weeks following the third email.

## **Instrumentation**

An original instrument was developed by the researcher to assess agriculture teaching faculty involvement in and perceptions of study abroad for students. To ensure content validity, an extensive review of the literature was conducted to identify (a) activities associated with study abroad programs in which faculty can be/are involved, (b) the KSAs most frequently identified as being outcomes of study abroad programs, (c) institutional and individual-level factors found to influence faculty study abroad perceptions and involvement, and (d) factors that influence faculty involvement in other components of internationalization that may be transferrable to study abroad. The developed questionnaire was then reviewed for content and face validity by panel of faculty and one graduate student with collective proficiencies in study abroad program development and instrument development. The panel deemed the instrument acceptable. Lastly, *post hoc* reliability estimates were calculated using Cronbach's alpha.

The following seven sections of the survey instrument were used for data analysis in this study: (a) faculty involvement in study abroad programs; (b) faculty agreement with KSAs as outcomes of studying abroad, (c) faculty perceived importance of KSA outcomes, (d) faculty awareness of study abroad programs, (e) faculty perceptions of study abroad programs as a priority, (f) faculty prior international experience (PIE), and (g) faculty personal and professional characteristics.

The first section of the instrument was designed to assess the active involvement of agriculture teaching faculty in activities associated with increasing student participation in study abroad programs. Faculty participants were asked to indicate by checking all that apply which of the 12 activities they have conducted. Responses were coded (0 = item not selected; 1 = item selected), and a composite score was computed. The second section of the instrument was designed to measure agriculture teaching faculty perceptions of the KSAs students develop as a result of

studying abroad. Exploratory factor analysis revealed the KSA Outcome Agreement construct comprised seven items. Faculty were asked to indicate their agreement using a 6-point Likert-type scale (1 = *disagree strongly*, 2 = *disagree*, 3 = *disagree slightly*, 4 = *agree slightly*, 5 = *agree*, 6 = *agree strongly*). A mean score was created to represent faculty agreement with KSAs. The internal consistency reliability for this scale was  $\alpha = .92$ .

The third section of the instrument was designed to measure agriculture teaching faculty perceptions of the importance of select KSAs for professionals in their field. Items in this construct were intended to mirror the items in the KSA Agreement construct. Exploratory factor analysis revealed the KSA Outcome Importance construct comprised 10 items. Faculty were asked to indicate their agreement using a 6-point Likert-type scale (1 = *disagree strongly*, 2 = *disagree*, 3 = *disagree slightly*, 4 = *agree slightly*, 5 = *agree*, 6 = *agree strongly*). A mean score was created to represent agriculture teaching faculty perceptions of KSA importance. The internal consistency reliability for this scale was  $\alpha = .94$ . The fourth section of the instrument was designed to assess agriculture teaching faculty knowledge and awareness of study abroad programs and associated procedures. Exploratory factor analysis resulted in the inclusion of 5 items in the Study Abroad Awareness construct. Faculty were asked to indicate their agreement using a 6-point Likert-type scale (1 = *disagree strongly*, 2 = *disagree*, 3 = *disagree slightly*, 4 = *agree slightly*, 5 = *agree*, 6 = *agree strongly*). A mean score was created to represent agriculture teaching faculty awareness of study abroad programs. The internal consistency reliability for this scale was  $\alpha = .87$ .

The fifth section of the instrument was developed to measure agriculture teaching faculty perception of the priority given to increasing student participation in study abroad programs. Exploratory factor analysis resulted in the inclusion of five items in the Study Abroad Priority construct. Faculty were asked to indicate their agreement using a 6-point Likert-type scale (1 = *disagree strongly*, 2 = *disagree*, 3 = *disagree slightly*, 4 = *agree slightly*, 5 = *agree*, 6 = *agree strongly*). A mean score was created to represent agriculture teaching faculty perceptions of study abroad priority. The internal consistency reliability for this scale was  $\alpha = .89$ . The sixth section of the instrument was designed to assess the prior international experience (PIE) of agriculture teaching faculty. To measure PIE, a summated score was computed. Faculty participants were asked to indicate by checking all that apply which of the 13 experiences they had acquired. Responses were coded (1 = item selected, 0 = item not selected), and a composite score was computed. Lastly, six demographic items were used to describe the population.

## **Data Analysis**

Data were analyzed using the SPSS24 software package. Data analysis for research objective one consisted of calculative descriptive statistics. Research questions two through six were analyzed by employing a one-way ANOVA. A statistical significance level of .05 was established *a priori* for all statistical tests employed. Levene's test was utilized to ensure the assumption of equality of error variances was not violated. Robust tests of equality of means included Welch's statistic. Multiple comparisons included Tukey's HSD and Games-Howell (Field 2013).

## Findings

### Objective 1: Describe Agriculture Faculty

Objective one sought to describe agriculture teaching faculty in terms of their (a) involvement in study abroad, (b) agreement with the KSAs students gain as outcomes of study abroad, (c) perceived importance of KSA outcomes of study abroad for professionals in their field, (d) awareness of study abroad opportunities and associated elements, (e) perceived priority placed on increasing student participation in study abroad, and (f) PIE.

**Involvement in study abroad.** The first section of objective one was concerned with faculty involvement in study abroad. A composite score was computed for Involvement, and frequencies and percentages were reported for individual items. The composite scores for Involvement ranged from 1 to 12, with an overall mean score of 4.60 ( $SD = 3.17$ ; see Table 1).

Table 1.

*Agriculture Teaching Faculty Involvement in Study Abroad (N = 184)*

Variable	<i>f</i>	%
I have encouraged students I teach to study abroad	128	69.6
I have encouraged students I advise to study abroad	115	62.5
I have used time in class to inform students I teach of study abroad opportunities in the College of Agriculture	82	44.6
I have met with students I advise to assist them with the academic planning associated with studying abroad	62	33.7
I have helped design a study abroad program for students	52	28.3
I have used time in class to inform students I teach of scholarships/other sources of funding for studying abroad	47	25.5
I have personally led a study abroad program for students	43	23.4
I have helped connect students I advise with a study abroad coordinator (or other personnel) from the international programs office on campus	40	21.7
I have used time in class to inform students I teach of upcoming study abroad fairs	40	21.7
I have invited students who have studied abroad previously to guest speak in one or more of my classes	30	16.3
I have met with students I advise to assist them with allocating scholarships/other sources of funding for studying abroad	28	15.2
I have invited someone from the office of international programs to guest speak in one or more of my classes	23	12.5

*Note:* Percentages do not total 100% as a result of multiple selection format.

Involvement Summate Score Mean = 4.60,  $SD = 3.17$

**Agreement with KSAs as outcomes of study abroad.** This section of objective one was concerned with faculty agreement with KSAs as outcomes of study abroad. The overall mean of the KSA outcome agreement construct was 4.94 ( $N = 183$ ;  $SD = .80$ ). All KSA outcome agreement items fell within the limits of *Agree*, with highest agreement reported for (a) *studying*

*abroad better prepares students for international careers* ( $M = 5.19$ ;  $SD = .89$ ), followed by (b) *studying abroad increases students' knowledge of global issues* ( $M = 5.14$ ;  $SD = .89$ ). The KSA outcome agreement item with the lowest agreement from faculty was *studying abroad increases students' ability to think critically to solve problems in diverse settings* ( $M = 4.56$ ;  $SD = 1.10$ ).

**Importance of KSA outcomes.** This section of objective one was concerned with faulty perceptions of the importance of KSA outcomes associated with study abroad. Responses were missing from three participants. The overall mean of the KSA outcome importance construct was 5.17 ( $N = 180$ ;  $SD = .76$ ). The highest rated KSA outcome importance item was *thinking critically to solve problems in diverse setting is important for professionals in my field* ( $M = 5.57$ ;  $SD = .64$ ), which fell within the limits of *Agree strongly*. All remaining KSA outcome importance items fell within the limits of *Agree*. The items with the lowest agreement were (a) *developing international networks is important for professionals in my field* ( $M = 4.92$ ;  $SD = 1.04$ ), followed by (b) *being able to compete in the global job market is important for professionals in my field* ( $M = 4.82$ ;  $SD = 1.08$ ).

**Study abroad awareness.** This section of objective one was concerned with faulty awareness of elements associated with study abroad. The overall mean of the awareness construct was 3.93 ( $N = 179$ ;  $SD = 1.13$ ). The highest rated items were (a) *I am aware of study abroad opportunities relevant to my students* ( $M = 4.41$ ;  $SD = 1.26$ ), followed by (b) *I am familiar with the office of international programs at my university* ( $M = 4.39$ ;  $SD = 1.35$ ). The mean scores for these items were within the limits of *Agree slightly*. The lowest rated item was *I am familiar with the process of transferring study abroad credits to students' degree plan at their home university* ( $M = 3.28$ ;  $SD = 1.45$ ), which fell within the limits of *Disagree slightly*.

**Study abroad priority.** This section of objective one was concerned with faulty perceptions of the priority given to increasing student participation in study abroad. The overall mean of the study abroad priority construct was 3.93 ( $N = 178$ ;  $SD = 1.06$ ), and the mean scores of all items fell within the limits of *Agree slightly*. Faculty reported highest agreement for the items (a) *increasing student participation in study is an institutional priority of my university* ( $M = 4.37$ ;  $SD = 1.15$ ), followed by (b) *increasing student participation in study abroad is a priority of the college of agriculture at my university* ( $M = 4.34$ ;  $SD = 1.20$ ). The study abroad priority item for which faculty reported the lowest agreement was *increasing student participation in study abroad is a priority among faculty in my department* ( $M = 3.58$ ;  $SD = 1.25$ ).

**PIE.** The final segment of objective one was concerned with the PIE of faculty. The summated scores for PIE ranged from 1 to 12, with an overall mean score of 6.88 ( $SD = 2.59$ ). Frequencies and percentages were reported for individual items, see Table 2).

Table 2.

*Agriculture Teaching Faculty Prior International Experience (N = 184)*

Variable	<i>f</i>	%
I have interacted with international students, international faculty members, and/or visiting international scholars at my university	165	89.7
I have colleagues from a country other than the United States	163	88.6
I have attended an international conference (includes those located in the United States)	162	88.0
I have been involved in international collaborative research	126	68.5
I lived a country other than the United States for a period of one month or more	101	54.9
I have participated in international activities on campus	90	48.9
I have worked in a country other than the United States	86	46.7
I have traveled abroad with students	84	45.7
I have taught a course on campus with an international focus	61	33.2
I have taught at a university in a country other than the United states	59	32.1
I have led a study abroad program for students	45	24.5
I was born in a country other than the United States	42	22.8
I have participated in a study abroad program for faculty	26	14.1

*Note:* Percentages do not total 100% due to multiple selection format of items.

**Objective 2: Comparison of Agriculture Teaching Faculty by Institutional Affiliation**

A one-way ANOVA was employed for objective two to compare faculty by institutional affiliation on their involvement in study abroad, agreement with KSAs as outcomes of study abroad, perceived importance of KSA outcomes, study abroad awareness, perceived priority of study abroad, and PIE. To ensure the assumption of equality of error variances was not violated, Levene's test was employed prior to the one-way ANOVA. Levene's statistic was significant only for Study Abroad Priority ( $p = .03$ ). The only significant difference observed between institutional groups was PIE, for which the ANOVA yielded  $F(1, 174) = 4.94$ ;  $p = .028$ ;  $\eta^2 = .028$  (see Table 3). The mean score for PIE was greater for UF faculty ( $M = 7.15$ ;  $SD = 2.51$ ) than for LSU faculty ( $M = 6.21$ ;  $SD = 2.69$ ).

Table 3.

*ANOVA Summary Table of Agriculture Teaching Faculty PIE by Institutional Affiliation*

Source	<i>SS</i>	<i>df</i>	<i>MS</i>	<i>F</i>	<i>p</i>
PIE					
Between Groups	32.49	1	32.49	4.94	.028
Within Groups	1144.76	174	6.58		
Total	1177.25	175			

### Objective 3: Comparison of Agriculture Teaching Faculty by Tenure Status

A one-way ANOVA was employed for objective three to compare faculty by tenure status. Levene's statistic was not significant, therefore, equality of error variance was assumed. The only significant difference observed between groups was PIE, for which the ANOVA yielded  $F(1, 174) = 4.85$ ;  $p = .029$ ;  $\eta^2 = .027$  (see Table 4). The mean score for PIE was greater for tenured faculty ( $M = 7.21$ ;  $SD = 2.59$ ) than for untenured faculty ( $M = 6.34$ ;  $SD = 2.52$ ).

Table 4.

*ANOVA Summary Table of Agriculture Teaching Faculty PIE by Tenure Status*

Source	SS	df	MS	F	p
PIE					
Between Groups	31.93	1	31.93	4.85	.029
Within Groups	1145.32	174	6.58		
Total	1177.25	175			

### Objective 4: Comparison of Agriculture Teaching Faculty by Professional Rank

One-way ANOVA was employed for objective four to compare faculty by professional rank (instructor, assistant professor, associate professor, full professor). Levene's statistic was not significant and equality of error variance was assumed. The only significant difference observed between groups was PIE, for which the ANOVA yielded  $F(3, 171) = 2.71$ ;  $p = .047$ ;  $\eta^2 = .045$  (see Table 5). Multiple comparisons for PIE were used to identify differences among faculty with the professional rank of instructor ( $M = 5.54$ ;  $SD = 2.25$ ), assistant professor ( $M = 6.90$ ;  $SD = 2.51$ ), associate professor ( $M = 7.14$ ;  $SD = 2.61$ ), and full professor ( $M = 7.20$ ;  $SD = 2.59$ ). The results of the multiple comparisons of PIE revealed significant differences between instructors and full professors. Full professors held the highest mean score for PIE, while instructors held the lowest mean score.

Table 5.

*ANOVA Summary Table of Agriculture Teaching Faculty PIE by Professional Rank*

Source	SS	df	MS	F	p
PIE					
Between Groups	53.12	3	17.71	2.71	.047
Within Groups	1115.82	171	6.53		
Total	1168.94	174			

### Objective 5: Comparison of Agriculture Teaching Faculty by Gender

One-way ANOVA was employed for objective five to compare faculty by gender. Significant differences were observed only for KSA Importance (see Table 7). Levene's test was employed prior to the one-way ANOVA and was significant for KSA Importance ( $p = .001$ ). Therefore, Welch's F statistic was reported for KSA Importance,  $F(1, 174) = 6.87$ ;  $p = .010$  (see Table 6).

Female faculty ( $M = 5.34$ ;  $SD = .56$ ) perceived greater importance of KSA outcomes associated with study abroad than did male professors ( $M = 5.07$ ;  $SD = .84$ ).

Table 6.

*ANOVA Summary Table of Agriculture Teaching Faculty Perceived KSA Importance by Gender*

Source	<i>SS</i>	<i>df</i>	<i>MS</i>	<i>F</i>	<i>p</i>
KSA Importance					
Between Groups	3.28	1	3.28	6.87*	.010
Within Groups	94.63	174	.541		
Total	97.91	175			

\*Welch's *F* reported

### **Objective 6: Comparison of Agriculture Teaching Faculty by Ethnicity**

A one-way ANOVA was employed for objective six to compare faculty by ethnicity. No significant differences were found between groups.

### **Conclusions and Recommendations**

Agriculture teaching faculty in this study were minimally involved overall in study abroad activities. The activities in which more faculty were involved included means of encouragement. Two thirds of faculty reported having encouraged students they teach to study abroad, and slightly less than two thirds had encouraged students they advise to study abroad. As faculty encouragement has been identified in prior studies as a positive influence on student participation in study abroad (O' Hara, 2009; Paus & Robinson, 2008), future research should examine why agriculture faculty do or do not encourage students they teach and/or advise to study abroad. Specifically, this line of research should examine faculty motivations for encouraging students to study abroad to determine if (a) faculty personal beliefs toward study abroad motivate them to encourage students, and/or if (b) encouragement is a more frequent activity among agriculture faculty merely because it requires relatively less time and financial investment than other forms of involvement. That being said, a follow up study to examine why one third of the agriculture teaching faculty in this study had never encouraged students to study abroad is warranted. Further, given the vague nature of the statement "I have encouraged students to study abroad," the follow up study should include qualitative inquiry with faculty who have encouraged students to study abroad could better identify how and to what extent these faculty encourage students.

Less than half of the agriculture teaching faculty in this study had been involved in any of the other activities associated with study abroad. The activities conducted by fewest faculty were assisting students with allocating funding for studying abroad and having invited someone from the office of international programs to guest speak in their class(es). As faculty can help facilitate student participation in study abroad by connecting students to the office of international programs (Lukosius & Festervand, 2013), future research should examine factors that influence this form of involvement from faculty. It should be noted, however, that inviting personnel from the office of international programs to guest speak in class has not been identified as a best or



only method for faculty to use to help connect students to the office of international programs. As such, future research should explore means for faculty to connect students to the office of international programs other than inviting personnel from international programs to guest speak in their class(es). Regarding faculty awareness, the element with which faculty were least aware was scholarships or other sources of funding for students to study abroad. Faculty awareness and involvement with assisting students in allocating funding for study abroad is consistent with prior research (Bond et al., 2003; Doyle et al., 2010) and warrants further examination.

Regarding faculty attitudes and beliefs toward the KSA outcomes of study abroad, faculty agreed studying abroad produces KSA outcomes among students and agreed strongly that these KSA outcomes were important for professionals in their field. Comparison of these findings suggest faculty perceived the outcomes associated with study abroad as important, but remained slightly less convinced that studying abroad actually produces these outcomes. For example, the ability to think critically in diverse settings was perceived by faculty as the most important KSA for professionals in their field. However, when asked about the outcomes of studying abroad, faculty agreed least with the statement that studying abroad increases students' ability to think critically to solve problems in diverse settings. The same, yet inverse effect, was observed regarding the ability to compete in the global job market. Faculty agreed most with the statement that studying abroad better prepares students for global careers, yet perceived the ability to compete in the global job market as the least important KSA for professionals in their field. These findings suggest that the nationally recognized need to produce globally cognizant agricultural professionals (Roberts, Harder, & Brashears, 2016; Stripling & Ricketts, 2016) has not been adopted by all agriculture faculty, and/or agriculture faculty do not perceive study abroad as the ideal means of producing such students. Future research should examine (a) why some faculty do not believe the study abroad outcomes reported frequently in prior research actually occur, and (b) faculty perceptions regarding the implications of globalization for agricultural professionals.

Priorities regarding study abroad may also differ across campuses. Agriculture teaching faculty in this study agreed that increasing student participation in study abroad was an institutional priority of their university, as well as a priority in their college. However, as consistent with prior research (Bond et al., Paus & Robinson, 2008; Schweitz, 2006), faculty reported slightly less agreement regarding the priority of increasing student participation in study abroad among administrators in their department. More so, faculty agreed least with increasing student participation in study abroad as a priority among fellow colleagues within their department. These findings pertain to professional dimension factors and warrant a more in depth assessment of the relationship between professional factors and faculty involvement in study abroad.

Analysis of variance revealed significant differences between LSU and UF faculty for PIE. However, no other significant differences were observed. This finding was surprising at it is inconsistent with the widely accepted postulation that institutional differences account for difference in faculty involvement in study abroad and other elements of internationalization (ACE, 2012; Dewey & Duff, 2009; Schwietz, 2006). However, as departmental differences have also been postulated as being largely influential in faculty involvement in study abroad (Bond et al., 2003; Childress, 2007; Green & Olsen, 2003), the findings of this study provoke consideration of departmental differences as carrying more weight than institutional differences. Differences in faculty involvement and perceptions of study abroad based on academic

department were not reported in this study due to a limitation of the survey instrument format. As such, this study should be replicated to include academic department as a factor.

Differences based on tenure status were observed only for PIE. Tenured faculty had more international experience than untenured faculty. Similarly, PIE was the only significant difference observed between faculty based on professional rank, specifically regarding differences between instructors and full professors. Tenure and promotion has been cited widely as a barrier to new faculty involvement in international activities (ACE, 2012; Bendelier & Zawacki-Richter, 2015; Dewey & Duff, 2009; Ellingboe, 1998; Estes et al., 2016; Green & Olsen, 2003). However, as few of these existing studies were conducted with agriculture faculty, it is recommended this study be replicated with a larger population of agriculture faculty to better determine the influence of tenure and promotion on their involvement.

Finally, future research is needed to further assess the conceptual model utilized in this study. Due to the limitations of the small overall population of this study, as well as the unequal population of LSU and UF faculty, this study should be replicated with faculty at other institutions to better describe the influence of institutional dimension factors on faculty involvement in study abroad. Regarding professional dimension factors, future research is needed to compare faculty study abroad involvement and perceptions by academic department. Moreover, the findings of this study warrant further examination of the influence of tenure and professional rank on agriculture faculty involvement in study abroad. As the findings of this study provided support for the inclusion of the personal dimension factors in the conceptual model, a recommended next step in this line of research is to examine the structural relationship between the personal dimension factors of the model.

## References

- American Council on Education (ACE). (2012). *Mapping internationalization on U.S. campuses: 2012 edition*. Washington, DC: American Council on Education. Retrieved from <http://www.acenet.edu/news-room/Documents/Mapping-Internationalizationon-US-Campuses-2012-full.pdf>
- Anderson, P. H., Lawton, L., Rexeisen, R. J., Hubbard, A. C. (2006). Short-term study abroad and intercultural sensitivity: A pilot study. *International Journal of Intercultural Relations*, 30(2006), 457–469. doi:10.1016/j.ijintrel.2005.10.004
- Andreasen, R. J. (2003). Barriers to international involvement. *Journal of International Agricultural and Extension Education*, 10(3), 65–69. doi:10.5191/jiaee.10308
- Bedenlier, S., & Zawacki-Richter, O. (2015). Internationalization of higher education and the impacts on academic faculty members. *Research in Comparative and International Education*, 10(2), 185–201. doi:10.1177/1745499915571707
- Bond, S. L., Qian, J., & Huang, J. (2003). The role of faculty in internationalizing the undergraduate curriculum and classroom experience. *Canadian Bureau for International Education*, 8, 1–20. Retrieved from <http://files.eric.ed.gov/fulltext/ED549872.pdf>

- Briers, G. E., Shinn, G. C., & Nguyen, A. N. (2010). Through students' eyes: Perceptions and aspirations of college of agriculture and life science students regarding international education experiences. *Journal of International Agricultural and Extension Education*, (17)2, 5–20. doi:10.5191/jiaee.2010.17201
- Bunch, J. C., Blackburn, J. J., Danjean, S. E., Stair, K. E., & Blanchard, L. D. (2015). Examining Louisiana State University College of Agriculture students' perceived motivators and barriers to participation in international experiences. *Journal of International Agricultural and Extension Education*, 22(3), 69–82. doi:10.5191/jiaee.2015.22305.
- Chieffo, L., & Griffiths, L. (2004). Large-scale assessment of student attitudes after a short-term study abroad program. *Frontiers: The Interdisciplinary Journal of Study Abroad*, 10, 165–177. Retrieved from <https://eric.ed.gov/?id=EJ891455>
- Childress, L. K. (2007). *Faculty engagement in the internationalization of higher education institutions: A literature analysis*. Paper presented at the Educational Symposium for Research and Innovations, Washington, DC. Retrieved from [http://curn.edu.co/documents\\_/ori/taller/material/2-Childress\\_ESRI07.pdf](http://curn.edu.co/documents_/ori/taller/material/2-Childress_ESRI07.pdf)
- Clarke, I., Flaherty, T. B., Wright, N. D., & McMillen, R. M. (2009). Student intercultural proficiency from study abroad programs. *Journal of Marketing Education*, 31(2), 173–181. doi:10.1177/0273475309355583
- Czerwionka, L., Artamonova, T., & Barbosa, M. (2015). Intercultural knowledge development: Evidence from student interviews during short-term study abroad. *International Journal of Intercultural Relations*, 49, 80–99. doi: 10.1016/j.ijintrel.2015.06.012
- Danjean, S. E., Bunch, J. C., & Blackburn, J. J. (2015). Examining the motivations and barriers influencing the decisions of Louisiana State University College of Agriculture freshmen to participate in international experiences. *Journal of International Agricultural and Extension Education*, 22(1), 49–62. doi:10.5191/jiaee.2015.22104.
- Dewey, P., & Duff, S. (2009). Reason before passion: Faculty views on internationalization in higher education. *Higher Education*, 58(4), 491–504. doi:10.1007/s10734-009-9207-z
- Dillman, D. A., Smyth, J. D., & Christian, L. M. (2009). *Internet, mail, and mixed-mode surveys: The tailored design method*. Hoboken, NJ: John Wiley & Sons, Inc.
- Doyle, S., Gendall, P., Meyer, L. H., Hoek, J., Trait, C., McKenzie, L., & Looiparg, A. (2010). An investigation of factors associated with student participation in study abroad. *Journal of Studies in International Education*, 14(5), 471–490. doi:10.1177/1028315309336032

- Ellingboe, B. J. (1998). Divisional strategies to internationalize a campus portrait: Results, resistance, and recommendations from a case study at a U.S. university. In J. A. Mestenhauser & B. J. Ellingboe (Eds.), *Reforming the higher education curriculum: Internationalizing the campus* (pp. 198–228). Phoenix, AZ: The Oryx Press.
- Estes, S., Hansen, M., & Edgar, L. D. (2016). University student and faculty needs, barriers, and expectations of international efforts and opportunities: A closer look at one land-grant university's college of agriculture. *Journal of International Agricultural and Extension Education*, 23(1), 33–47. doi:10.5191/jiaee.2016.23103
- Field, A. (2013). *Discovering statistics using IBM SPSS statistics*. Thousand Oaks, CA: SAGE Publications Ltd.
- Finkelstein, M. J., Walker, E., & Chen, R. (2013). The American faculty in an age of globalization: Predictors of internationalization of research content and professional networks. *Higher Education*, 66(3), 325–340. doi:10.1007/s10734-012-9607-3
- Green, M. F., & Olsen, C. L. (2003). *Internationalizing the campus: A user's guide*. Washington DC: American Council on Education. Retrieved from <http://www.d.umn.edu/vcaa/intz/users%20guide.pdf>
- Huberty, C. J., & Morris, J. D. (1989). Multivariate analysis versus multiple univariate analyses. *Psychological Bulletin*, 105(2), 302–308. doi:10.1037/0033-2909.105.2.302
- Institute of International Education (IIE). (2016a). *Leading institutions by study abroad total 2014/15: IIE Open doors report on international educational exchange*. Retrieved from <http://www.iie.org/opendoors>
- Institute of International Education (IIE). (2016b). *Open doors report on international educational exchange*. Retrieved from <http://www.iie.org/opendoors>
- Kehl, K., & Morris, J. (2008). Differences in global-mindedness between short-term and semester-long study abroad participants at selected private universities. *The Interdisciplinary Journal of Study Abroad*, 15, 67–79. Retrieved from <http://files.eric.ed.gov/fulltext/EJ878383.pdf>
- Lukosius, V., & Festervand, T. A. (2013). Marketing study abroad programs: A student recruitment model. *American Journal of Business Education*, 6(5), 483–494. doi:10.19030/ajbe.v6i5.8038
- National Survey of Student Engagement (NSSE). (2008). *Promoting engagement for all students: The imperative to look within*. Bloomington, IN: Indiana University Center for Postsecondary Research. [http://nsse.indiana.edu/NSSE\\_2008\\_Results/docs/withhold/NSSE2008\\_Results\\_revised\\_11-14-2008.pdf](http://nsse.indiana.edu/NSSE_2008_Results/docs/withhold/NSSE2008_Results_revised_11-14-2008.pdf)

- O'Hara, S. (2009). *Vital and overlooked: The role of faculty in internationalizing U.S. campuses* (White Paper Issue No. 6). Retrieved from Institute of International Education website: <http://www.iie.org/en/Research-and-Publications/Publications-and-Reports/IIE-Bookstore/Expanding-Study-Abroad-Capacity-at-US-Colleges-and-Universities#.V2xsEJPyvVo>
- Paige, R. M. (2005). Internationalization of higher education: Performance assessment and indicators. *Nagoya Journal of Higher Education*, 5, 99–122. Retrieved from <http://www.cshe.nagoya-u.ac.jp/publications/journal/no5/08.pdf>
- Parsons, L. R. (2010). The effects of an internationalized university experience on domestic students in the United States and Australia. *Journal of Studies in International Education*, 14(4), 313–334. doi:10.1177/1028315309331390
- Paus, E., & Robinson, M. (2008). Increasing study abroad participation: The faculty makes the difference. *The Interdisciplinary Journal of Study Abroad*, 17, 33–49. Retrieved from <http://files.eric.ed.gov/fulltext/EJ899295.pdf>
- Roberts, T. G., Harder, A., & Brashears, M. T. (Eds.). (2016). *American Association for Agricultural Education national research agenda: 2016-2020*. Gainesville, FL: Department of Agricultural Education and Communication
- Rowan-Kenyon, H. T., & Niehaus, E. K. (2011). One year later: The influence of a short-term study abroad experiences on students. *Journal of Student Affairs Research and Practice*, 48(2), 213–228. doi: 10.2202/1949-6605.6213
- Schwietz, M. (2006). *Internationalization of the academic profession: An exploratory study of faculty attitudes, beliefs, and involvement at public universities in Pennsylvania* (Unpublished doctoral dissertation). University of Pittsburgh, Pittsburgh, PA.
- Sjoberg, S. D., & Shabalina, O. I. (2010). More than a sight-seeing trip: Enhancing the value in short-term study abroad. *Business Education Innovation Journal*, 2(2), 46–58. Retrieved from [http://bejournal.com/images/BEIJ\\_V2N2\\_Dec2010text.pdf#page=46](http://bejournal.com/images/BEIJ_V2N2_Dec2010text.pdf#page=46)
- Stohl, M. (2007). We have met the enemy and he is us: The role of faculty in the internationalization of higher education in the coming decade. *Journal of Studies in International Education*, 11(3-4), 359–372. doi:10.1177/1028315307303923
- Stripling, C. T., & Ricketts, J. C. (2016). Research priority 3: Sufficient scientific and professional workforce that addresses the challenges of the 21st century. In T. G. Roberts, A. Harder, & M. T. Brashears (Eds.), *American Association for Agricultural Education national research agenda: 2016-2020* (pp. 29–35). Gainesville, FL: Department of Agricultural Education and Communication